



US00D715749S

(12) **United States Design Patent**  
**Mira et al.**

(10) **Patent No.:** **US D715,749 S**

(45) **Date of Patent:** **\*\* Oct. 21, 2014**

(54) **HIGH PERFORMANCE HIGH POWER  
TOWER HEAT SINK**

(71) Applicant: **Heatscape, Inc.**, Morgan Hill, CA (US)

(72) Inventors: **Ali Mira**, Morgan Hill, CA (US);  
**Yashar Mira**, Morgan Hill, CA (US);  
**Michael Mira**, Morgan Hill, CA (US)

(73) Assignee: **Heatscape, Inc.**, Morgan Hill, CA (US)

(\*\*) Term: **14 Years**

(21) Appl. No.: **29/473,923**

(22) Filed: **Nov. 26, 2013**

(51) **LOC (10) Cl.** ..... **13-03**

(52) **U.S. Cl.**  
USPC ..... **D13/179**

(58) **Field of Classification Search**  
CPC . H01L 23/427; H01L 23/467; H01L 23/3672;  
H01L 23/3677; H05K 7/20154; F28D  
15/0233; F28D 15/0266; F28D 15/0275  
USPC ..... D13/179; 165/80.3, 104.26, 104.33,  
165/122, 151, 185; 257/706, 707, 718-722;  
361/695, 697, 700, 702, 704, 709, 710,  
361/711, 719

See application file for complete search history.

(56) **References Cited**

U.S. PATENT DOCUMENTS

D533,145	S *	12/2006	O'Sullivan et al. ....	D13/179
7,249,626	B2 *	7/2007	Hao et al. ....	165/104.33
D579,423	S *	10/2008	Chang et al. ....	D13/179
D582,359	S *	12/2008	Chang .....	D13/179
8,322,403	B2 *	12/2012	Lin et al. ....	165/80.2
8,584,736	B2 *	11/2013	Li et al. ....	165/80.3
2006/0175045	A1 *	8/2006	Chen .....	165/104.33
2006/0266500	A1 *	11/2006	Lin et al. ....	165/104.33
2007/0107883	A1 *	5/2007	Chen .....	165/133

2007/0131390	A1 *	6/2007	Chen et al. ....	165/104.33
2008/0105408	A1 *	5/2008	Zhang et al. ....	165/104.33
2008/0115915	A1 *	5/2008	Chen .....	165/104.33
2009/0049691	A1 *	2/2009	Cheng et al. ....	29/890.03
2009/0050305	A1 *	2/2009	He et al. ....	165/182
2009/0173474	A1 *	7/2009	Chang .....	165/104.26
2009/0219690	A1 *	9/2009	Lin et al. ....	361/697
2010/0181047	A1 *	7/2010	Lin et al. ....	165/104.26
2010/0258287	A1 *	10/2010	Chen et al. ....	165/185
2011/0024087	A1 *	2/2011	Lin et al. ....	165/104.26
2011/0127012	A1 *	6/2011	Ma et al. ....	165/104.26
2012/0103572	A1 *	5/2012	Hwang et al. ....	165/104.26
2014/0138074	A1 *	5/2014	Huang .....	165/185

\* cited by examiner

*Primary Examiner* — Selina Sikder

(74) *Attorney, Agent, or Firm* — Kilpatrick Townsend & Stockton LLP

(57) **CLAIM**

The ornamental design for a high performance high power tower heat sink, as shown and described.

**DESCRIPTION**

FIG. 1 is a top perspective view of a high performance high power tower heat sink showing our new design; FIG. 2 is a bottom perspective view thereof; FIG. 3 is a front elevational view thereof; FIG. 4 is a top plan view thereof; FIG. 5 is a bottom plan view thereof; FIG. 6 is a left side elevational view thereof; FIG. 7 is a right side elevational view thereof; FIG. 8 is a disassembled view corresponding to the high performance high power tower heat sink of FIG. 1; and, FIG. 9 is another disassembled view corresponding to the high performance high power tower heat sink of FIG. 1. The broken line showing on the drawing disclosure is for illustrative purposes only and forms no part of the claimed design.

**1 Claim, 7 Drawing Sheets**

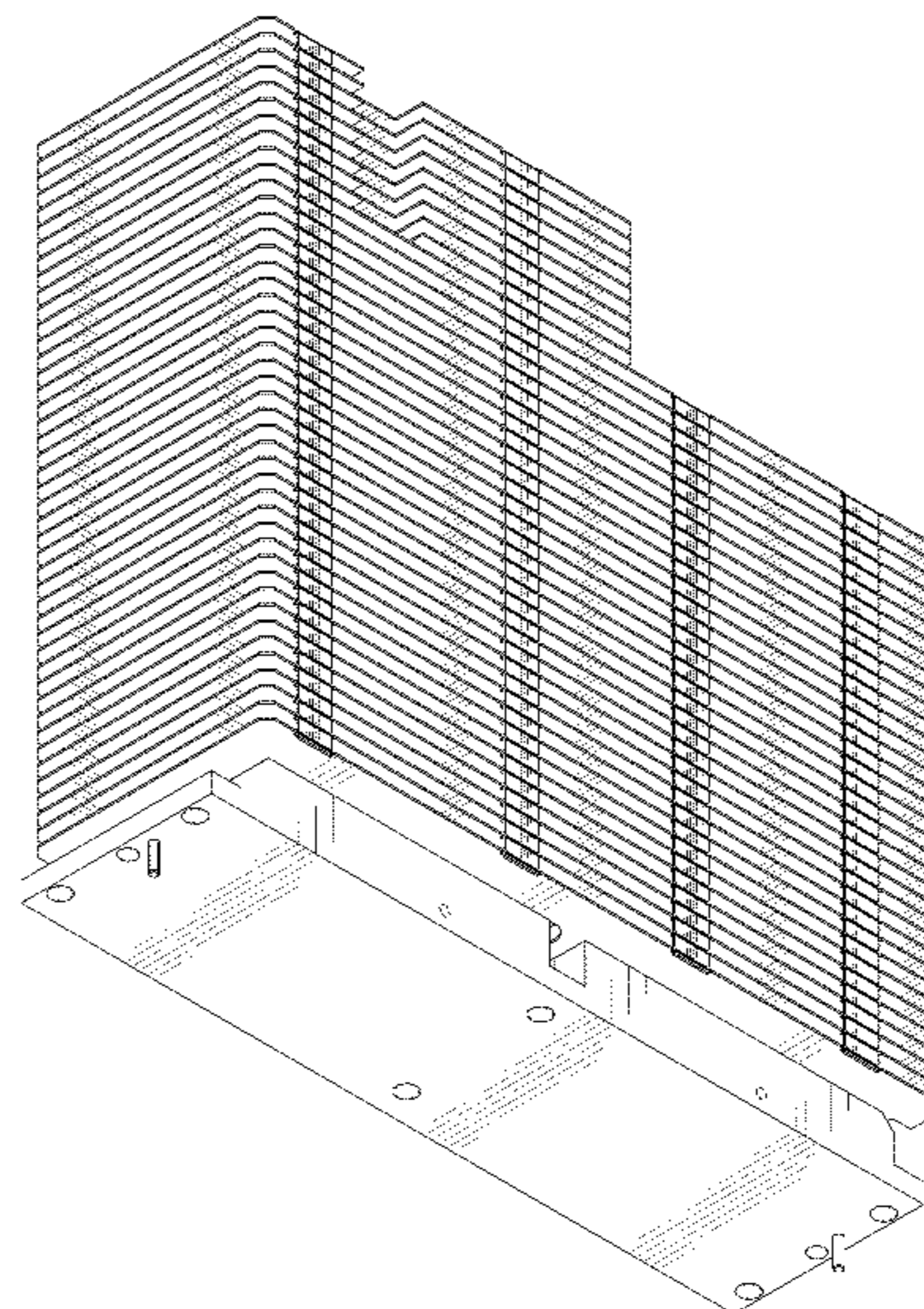
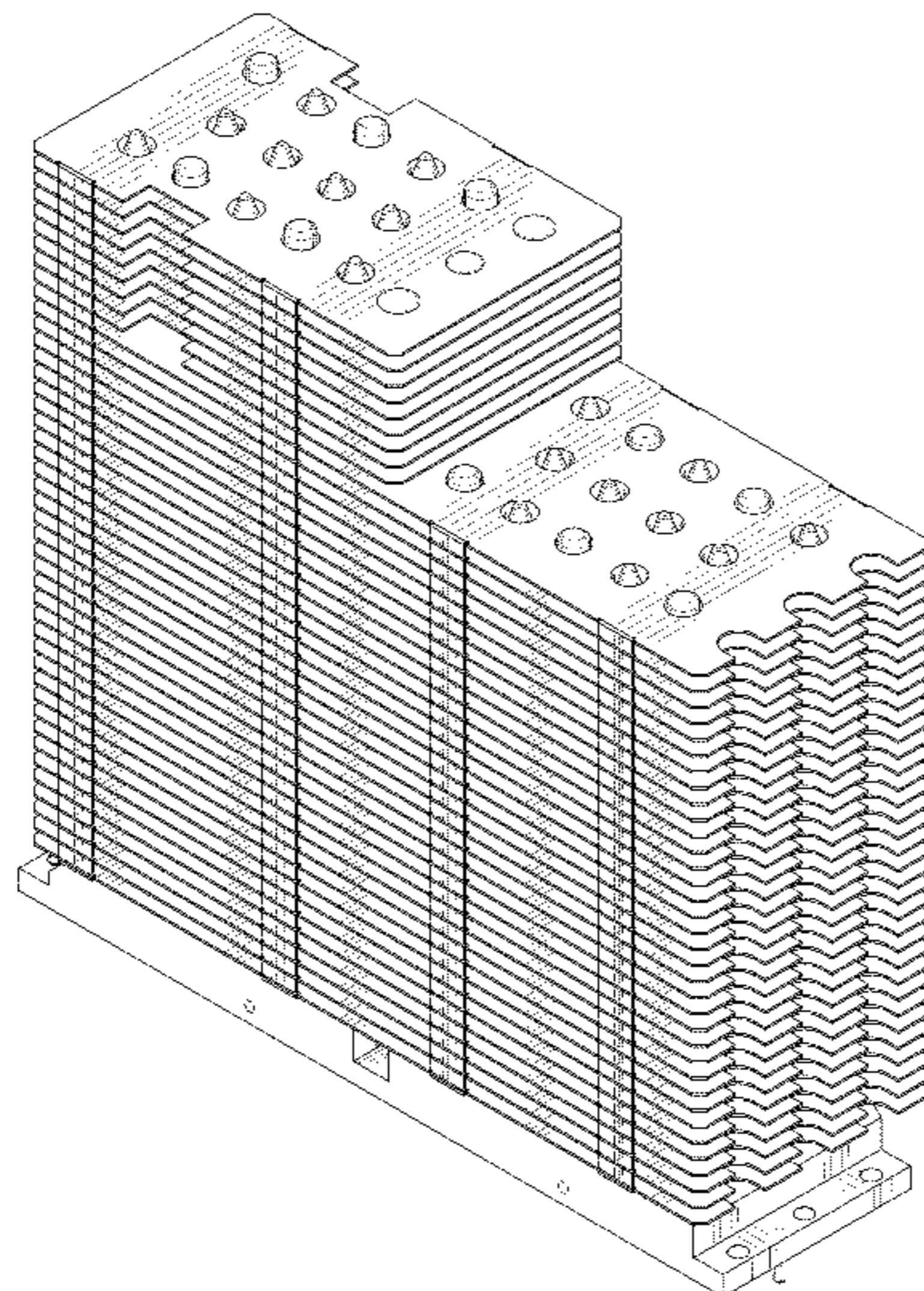

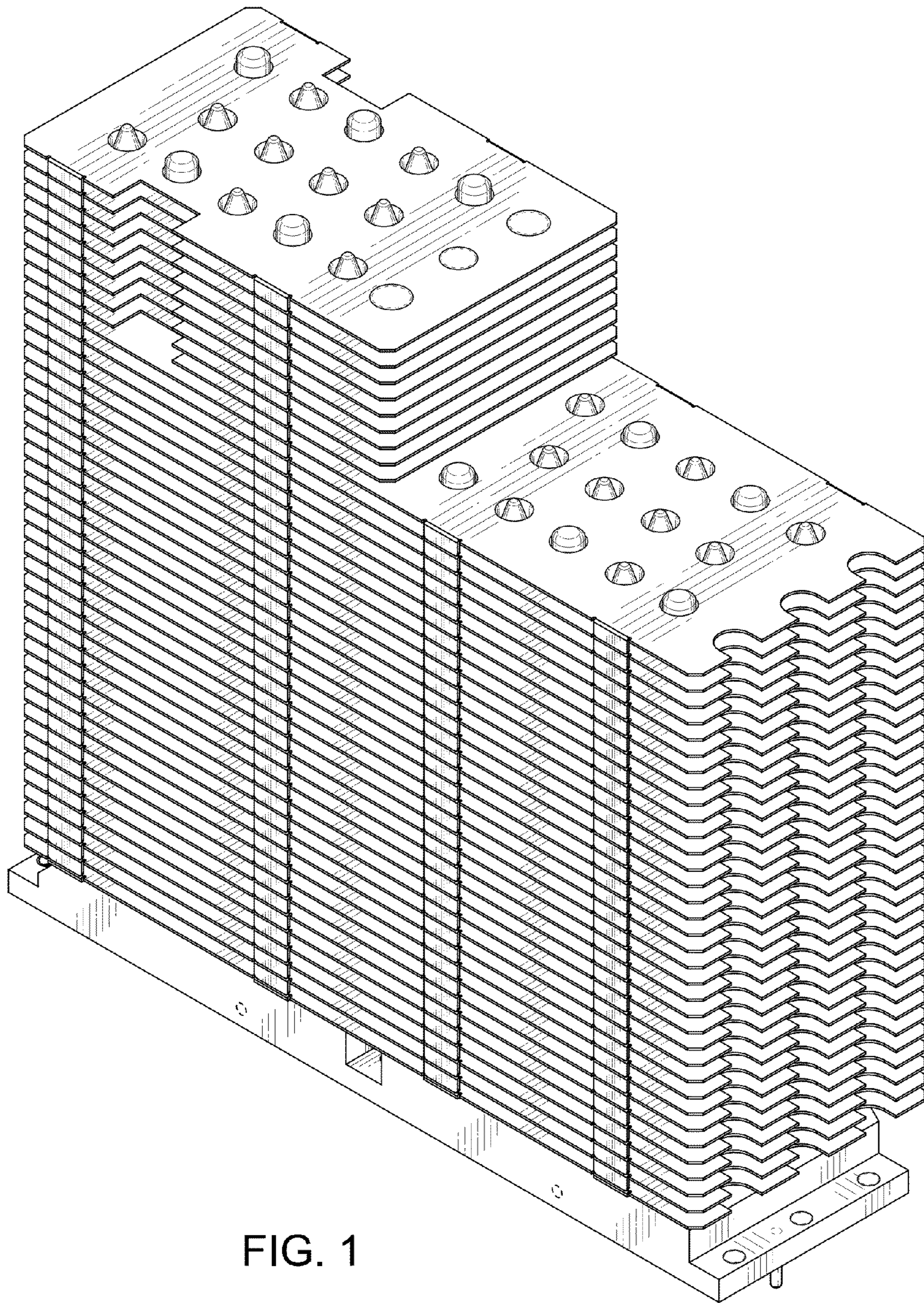

FIG. 1

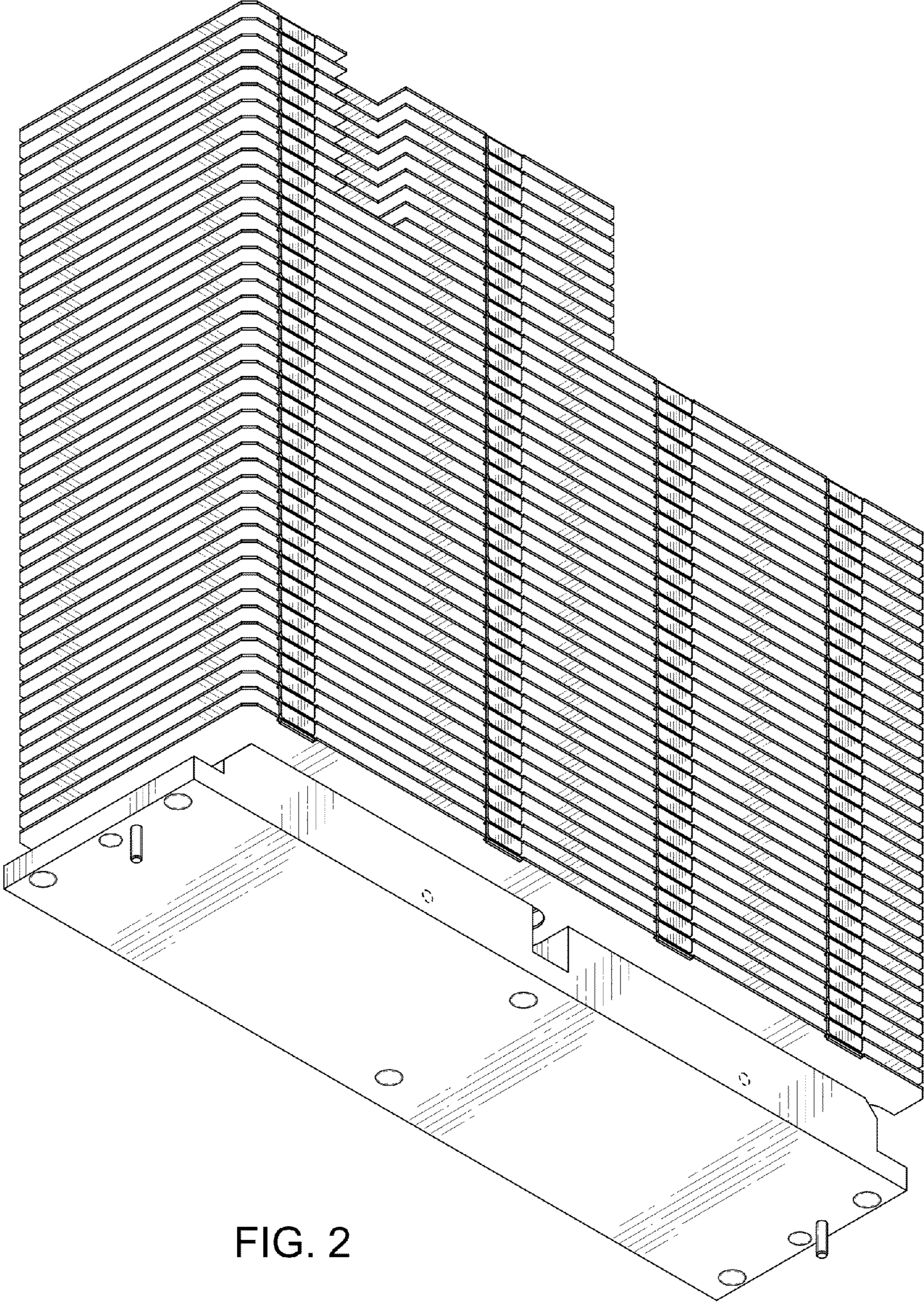

FIG. 2

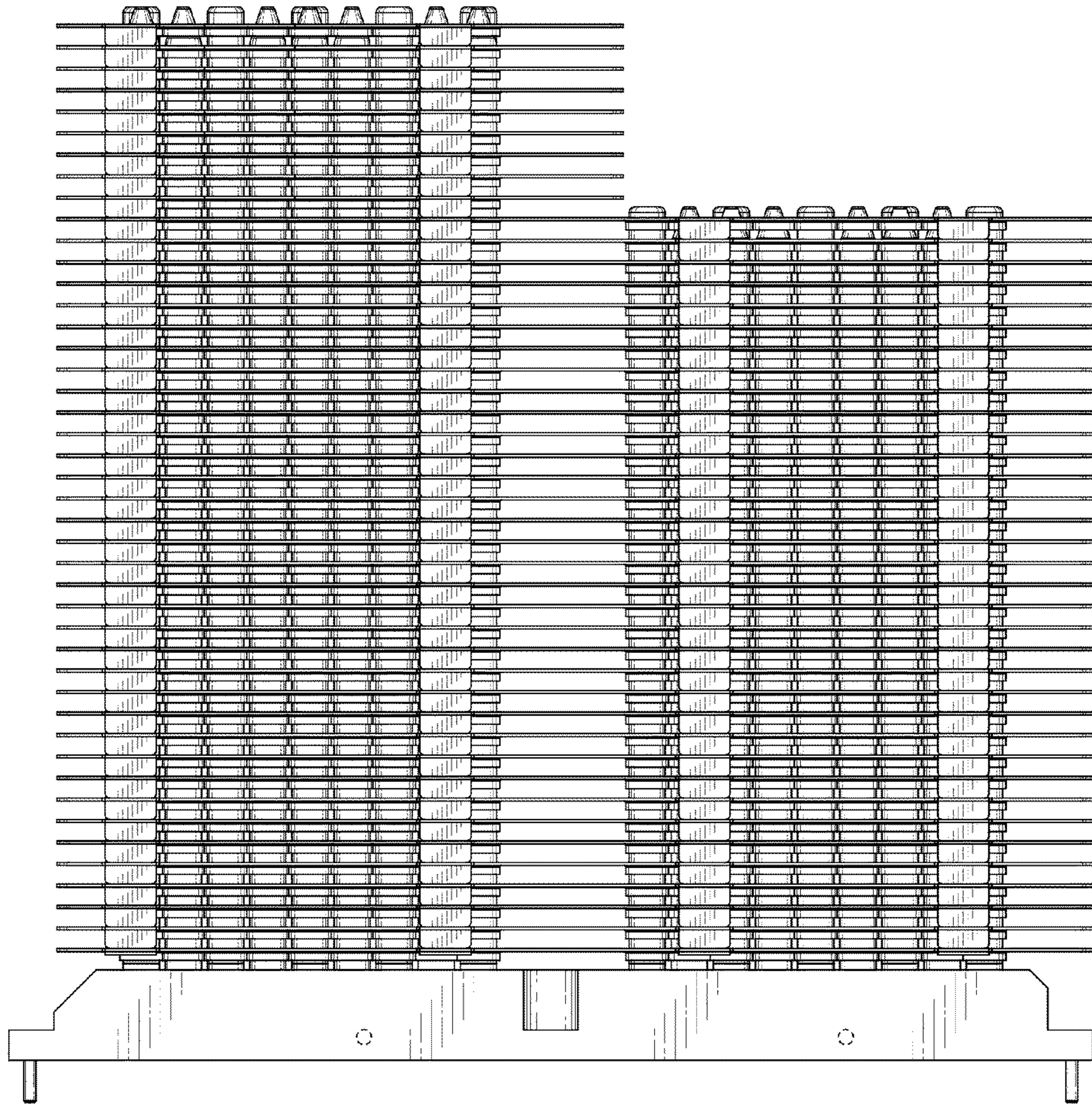

FIG. 3

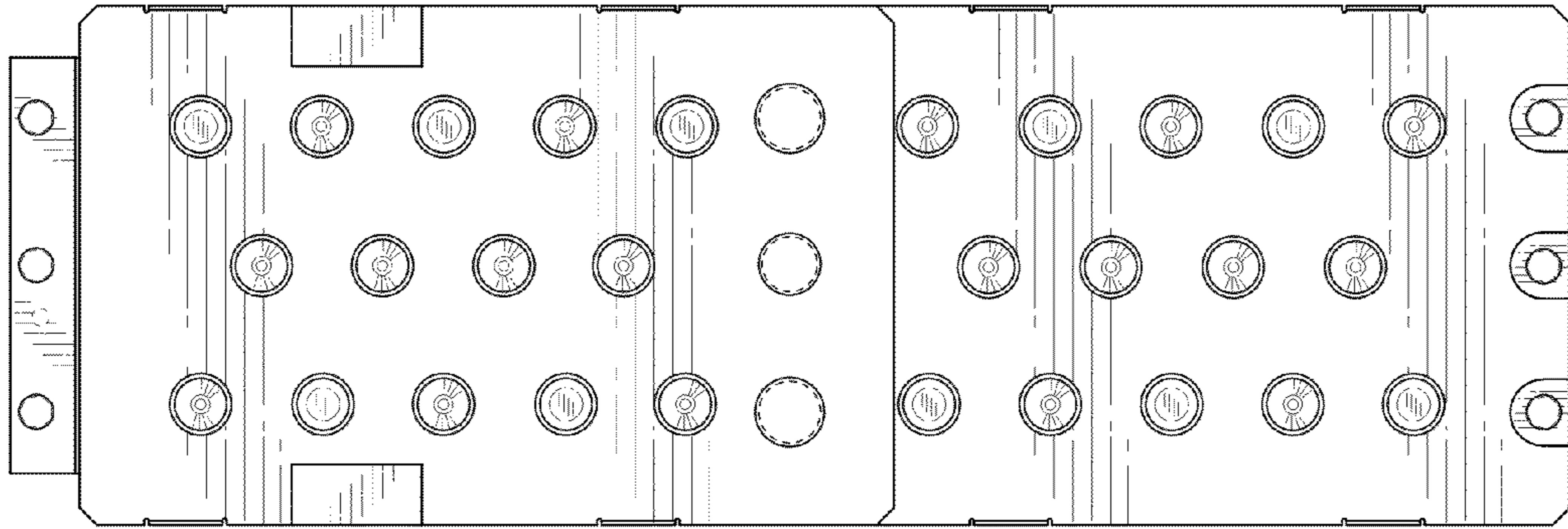

FIG. 4

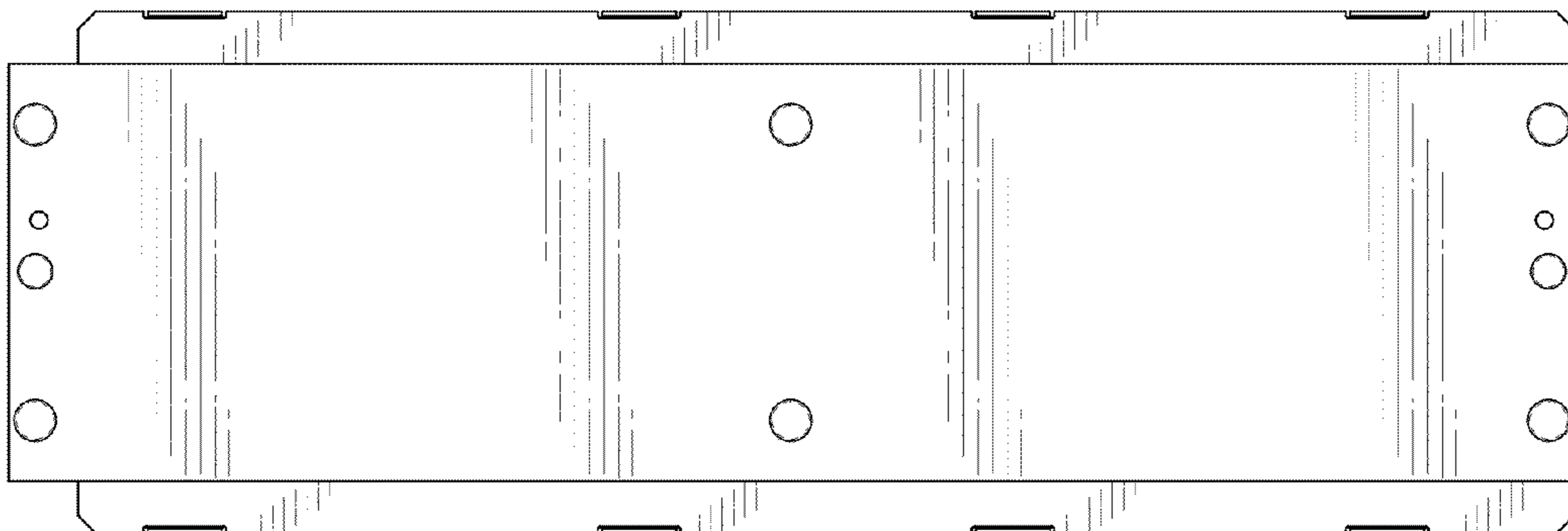

FIG. 5

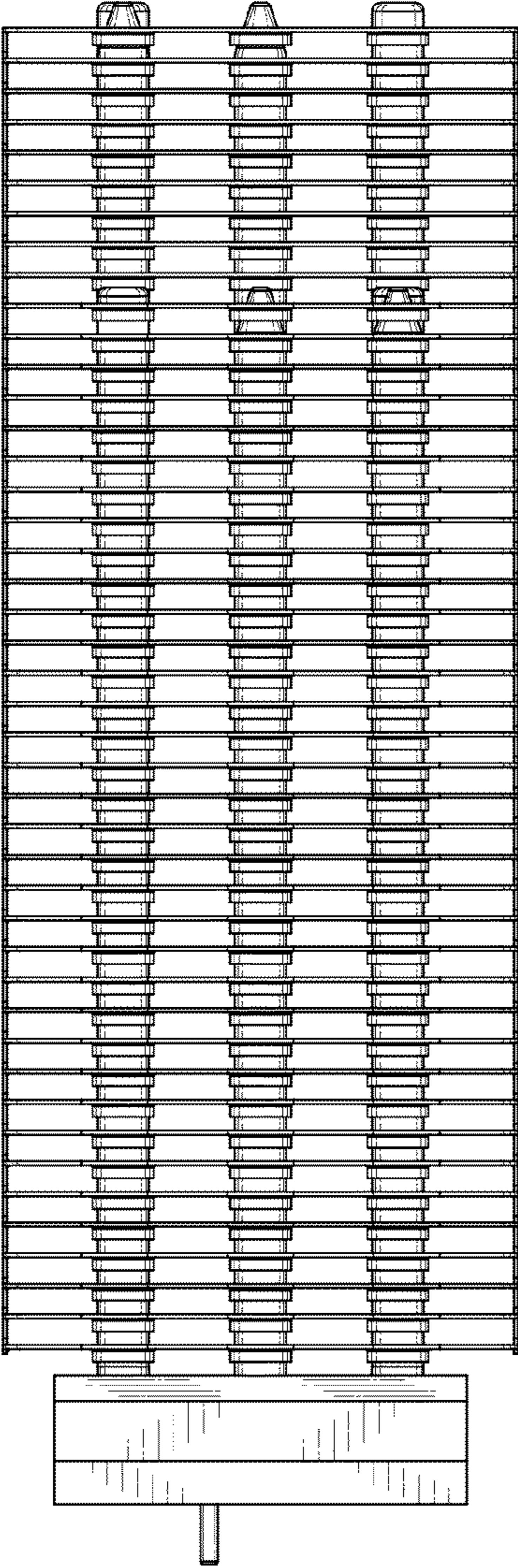

FIG. 6

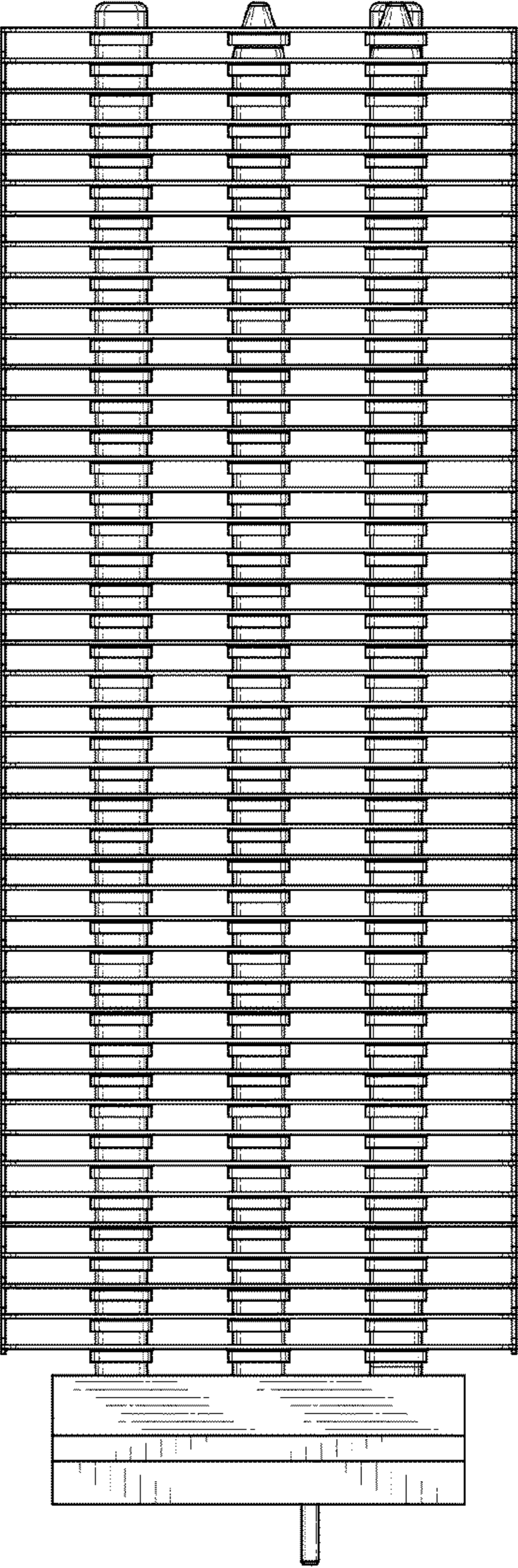

FIG. 7

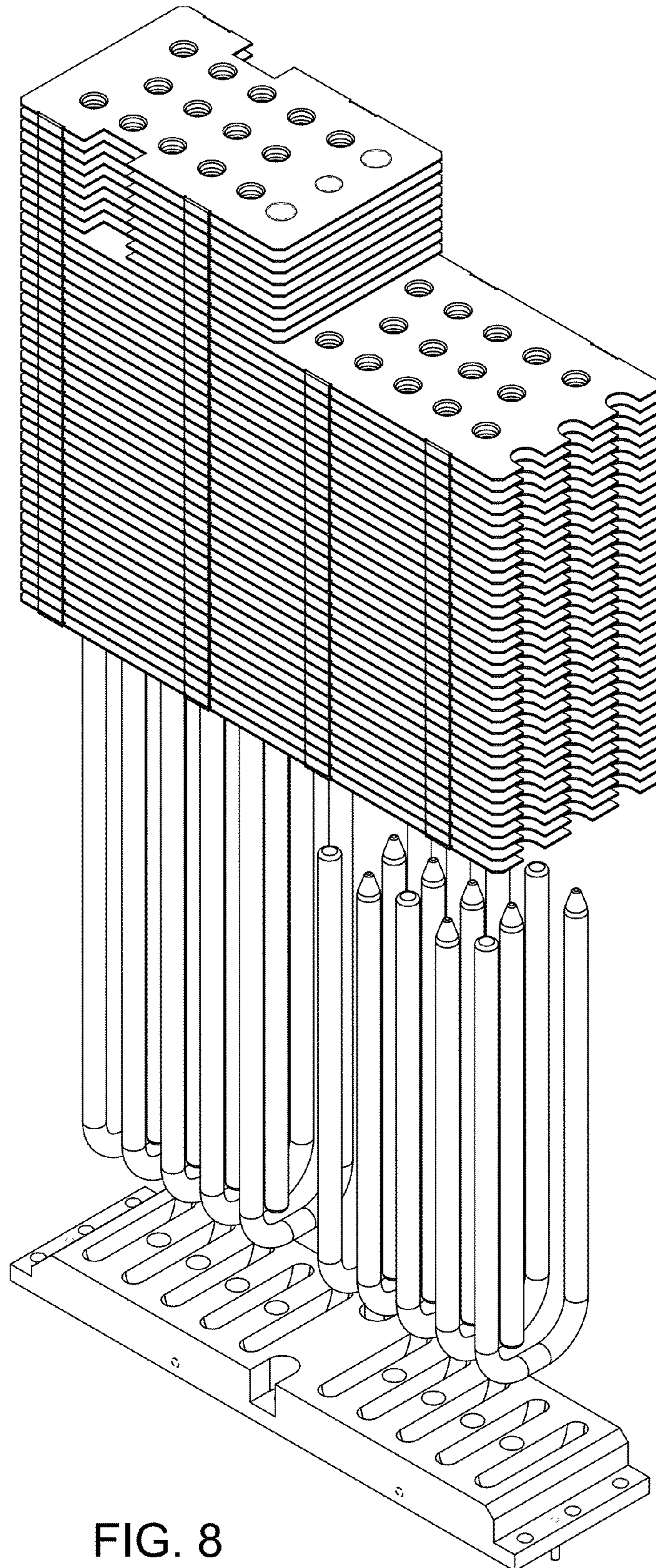

FIG. 8

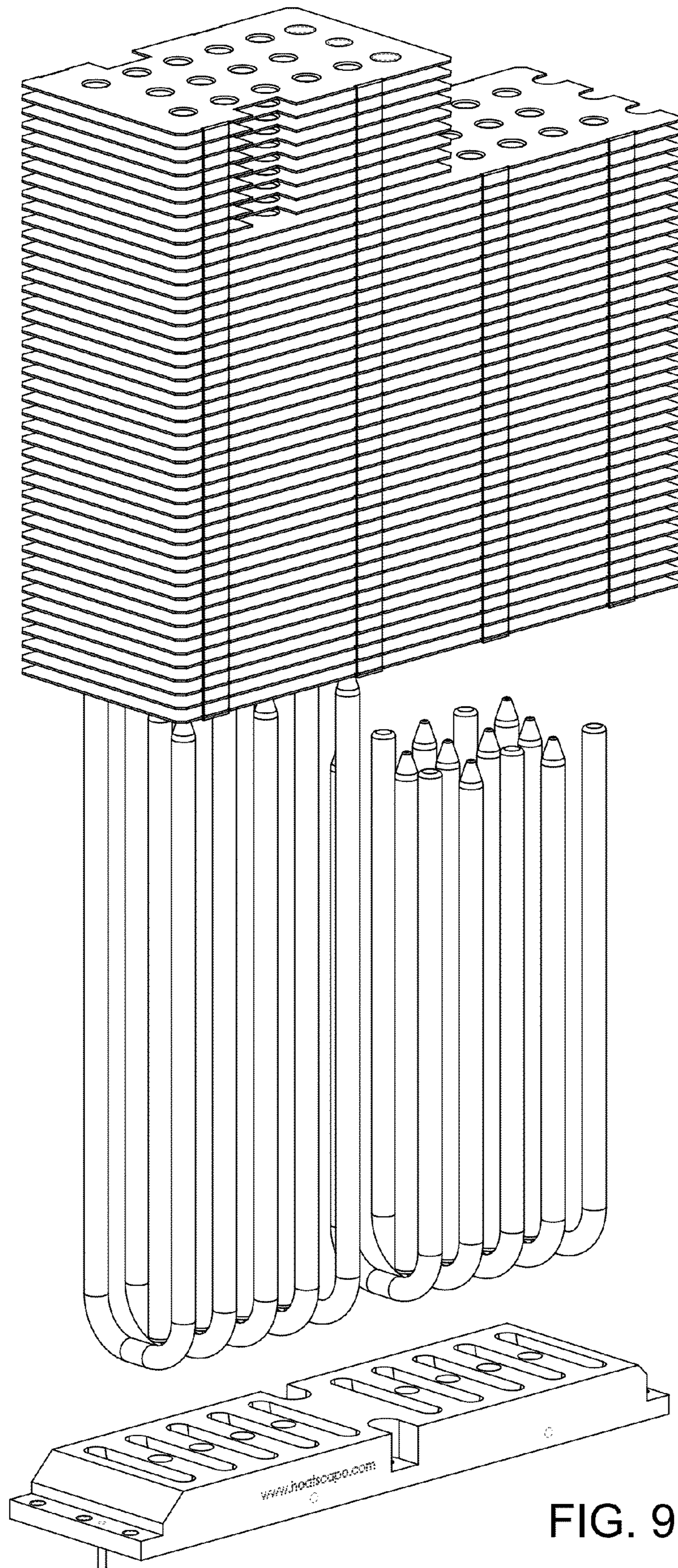

FIG. 9