



US00D715657S

(12) **United States Design Patent**
Montanaro, Jr.

(10) **Patent No.:** **US D715,657 S**

(45) **Date of Patent:** **** *Oct. 21, 2014**

- (54) **TRASH/WASTE BAG WITH EXTRA FLAP FOR HANGING**
- (76) Inventor: **Joseph Montanaro, Jr.**, Windham, NH (US)
- (*) Notice: This patent is subject to a terminal disclaimer.
- (**) Term: **14 Years**
- (21) Appl. No.: **29/425,674**
- (22) Filed: **Jun. 26, 2012**
- (51) **LOC (10) Cl.** **09-05**
- (52) **U.S. Cl.**
USPC **D9/703**
- (58) **Field of Classification Search**
USPC D9/702-714, 720-722, 424, 430-433, D9/414, 444, 418; 383/26, 119, 127, 33, 383/71-75, 103; 229/87.06, 87.08, 87.01, 229/92.1; 220/495.03, 495.01; D3/303, D3/201; 426/106; 428/35.2, 79, 199, 428/542.6; 281/2, 3.1, 5, 38, 51; 283/62, 283/117, 72, 74, 93, 103, 115; D19/1-10, D19/100; D5/57-61, 99; 402/79; 434/162
See application file for complete search history.

6,174,082	B1	1/2001	Pelky et al.	
D442,754	S *	5/2001	Gregoire	D34/1
6,224,259	B1	5/2001	Guerra	
D525,877	S *	8/2006	Wingfield	D9/706
7,192,190	B2	3/2007	Jung	
D627,664	S *	11/2010	Yang et al.	D9/703
D633,677	S *	3/2011	Blomberg	D34/5
D641,120	S *	7/2011	Montanaro, Jr.	D34/1
7,980,411	B2 *	7/2011	Kasbohm	220/495.11
8,066,144	B2 *	11/2011	McNamara et al.	220/495.11
D658,074	S *	4/2012	Kolovich et al.	D9/703
8,147,140	B2 *	4/2012	Williams et al.	383/33
2003/0190097	A1	10/2003	Hajianpour	
2009/0014603	A1	1/2009	Zima	

* cited by examiner

Primary Examiner — Caron D Veynar
Assistant Examiner — Abraham Bahta

(57) **CLAIM**

The ornamental design for a trash/waste bag with extra flap for hanging, as shown and described.

DESCRIPTION

FIG. 1 is a perspective view of a trash/waste bag with extra flap for hanging showing my new design;
 FIG. 2 is a side view (opposite side view is mirror image) thereof;
 FIG. 3 is a front view thereof;
 FIG. 4 is a back view thereof;
 FIG. 5 is a top view thereof;
 FIG. 6 is a bottom view thereof; and,
 FIG. 7 is another perspective view showing the trash/waste bag with extra flap for hanging in use.
 In FIG. 7, the broken lines showing of environmental structure for purposes of illustrating the trash/waste bag with extra flap for hanging in a condition of use. The broken lines and the structure they depict form no part of the claimed design.

1 Claim, 6 Drawing Sheets

(56) **References Cited**

U.S. PATENT DOCUMENTS

2,392,034	A	1/1946	Ellis et al.	
2,808,091	A	10/1957	Cumbler	
4,047,746	A	9/1977	Radowski	
4,332,347	A	6/1982	Clayton	
D298,307	S	11/1988	Balter et al.	
4,867,576	A	9/1989	Boyd	
D371,108	S *	6/1996	Baker	D12/416
D420,899	S *	2/2000	Jubar	D9/705

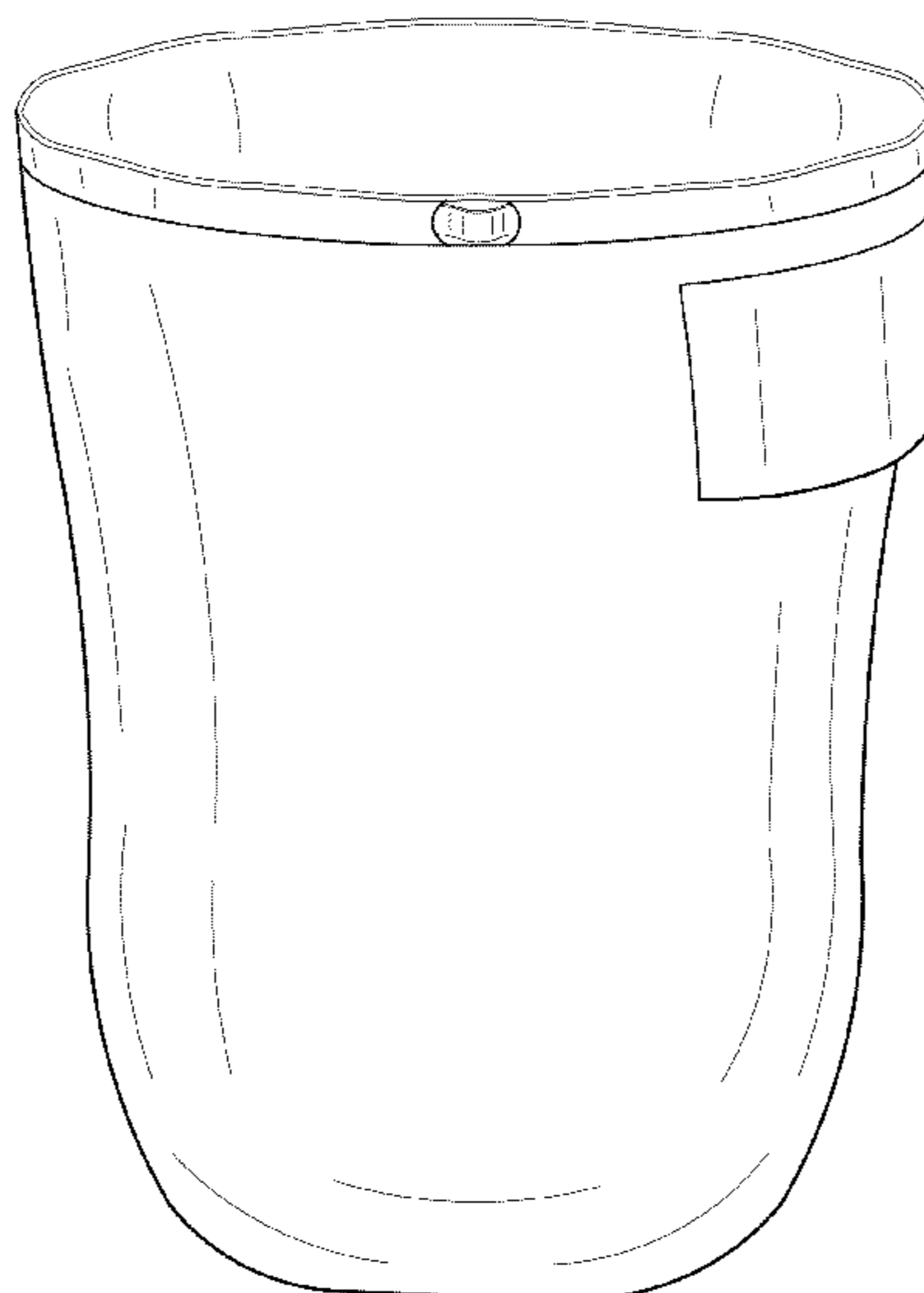

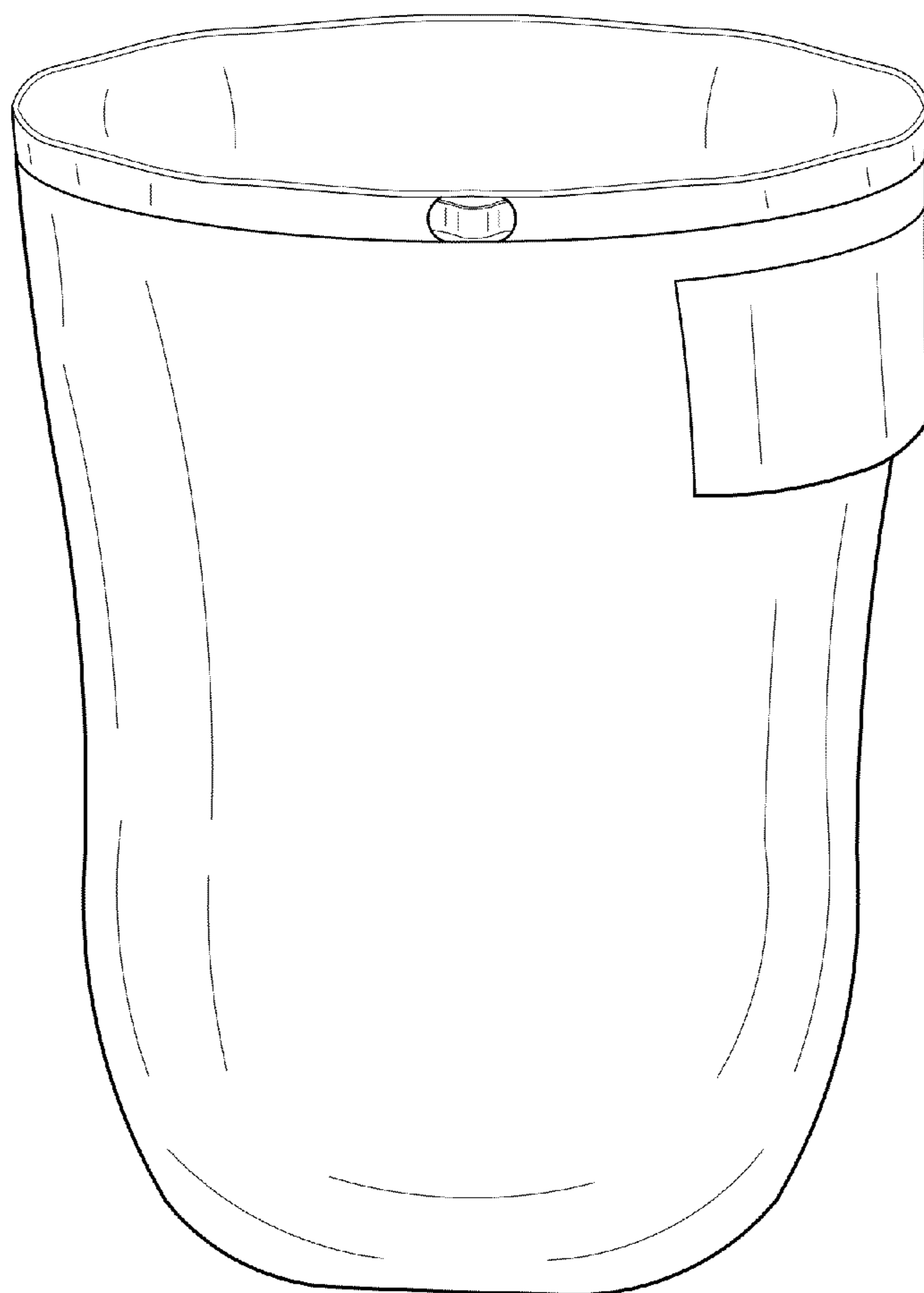

FIG. 1

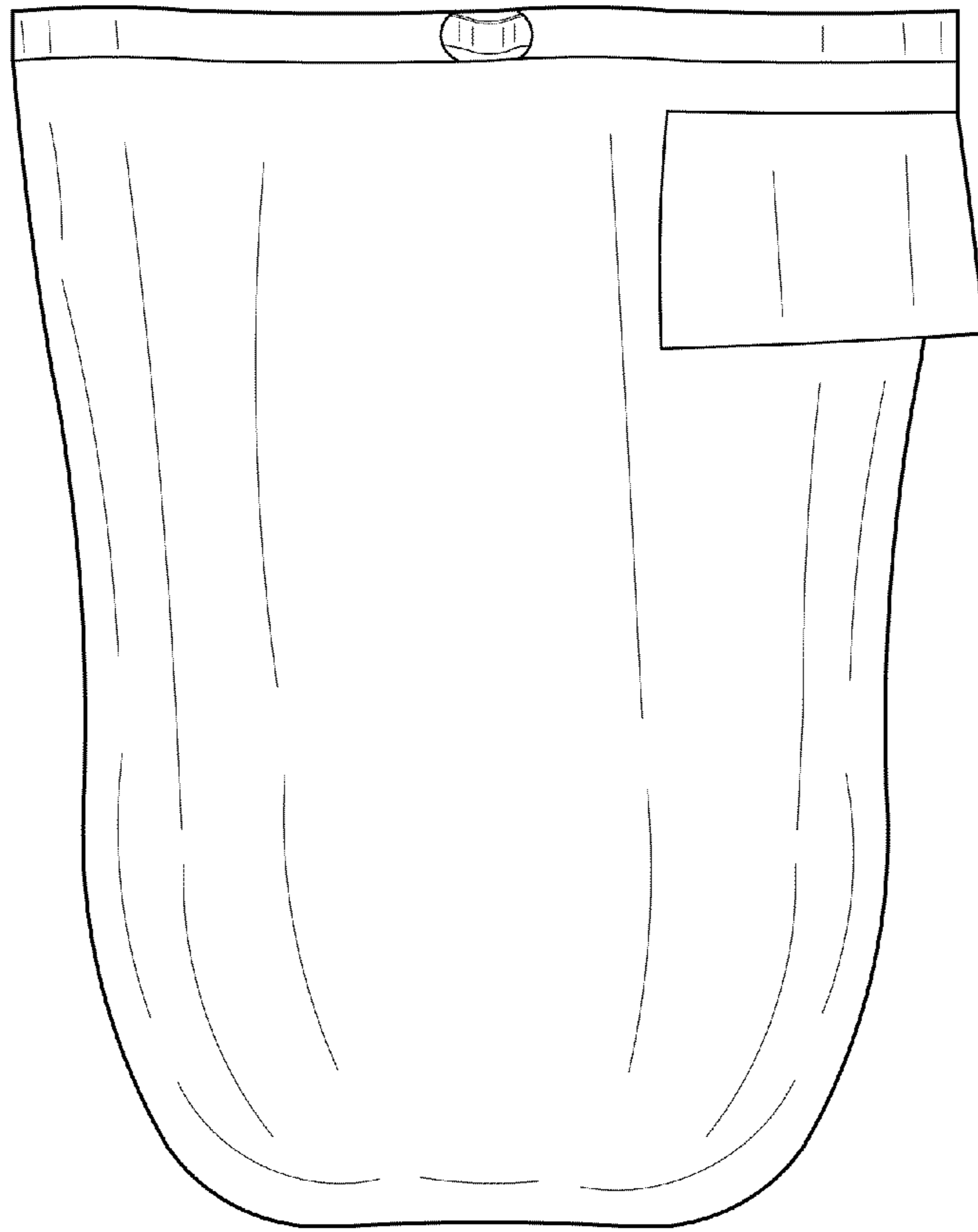

FIG. 2

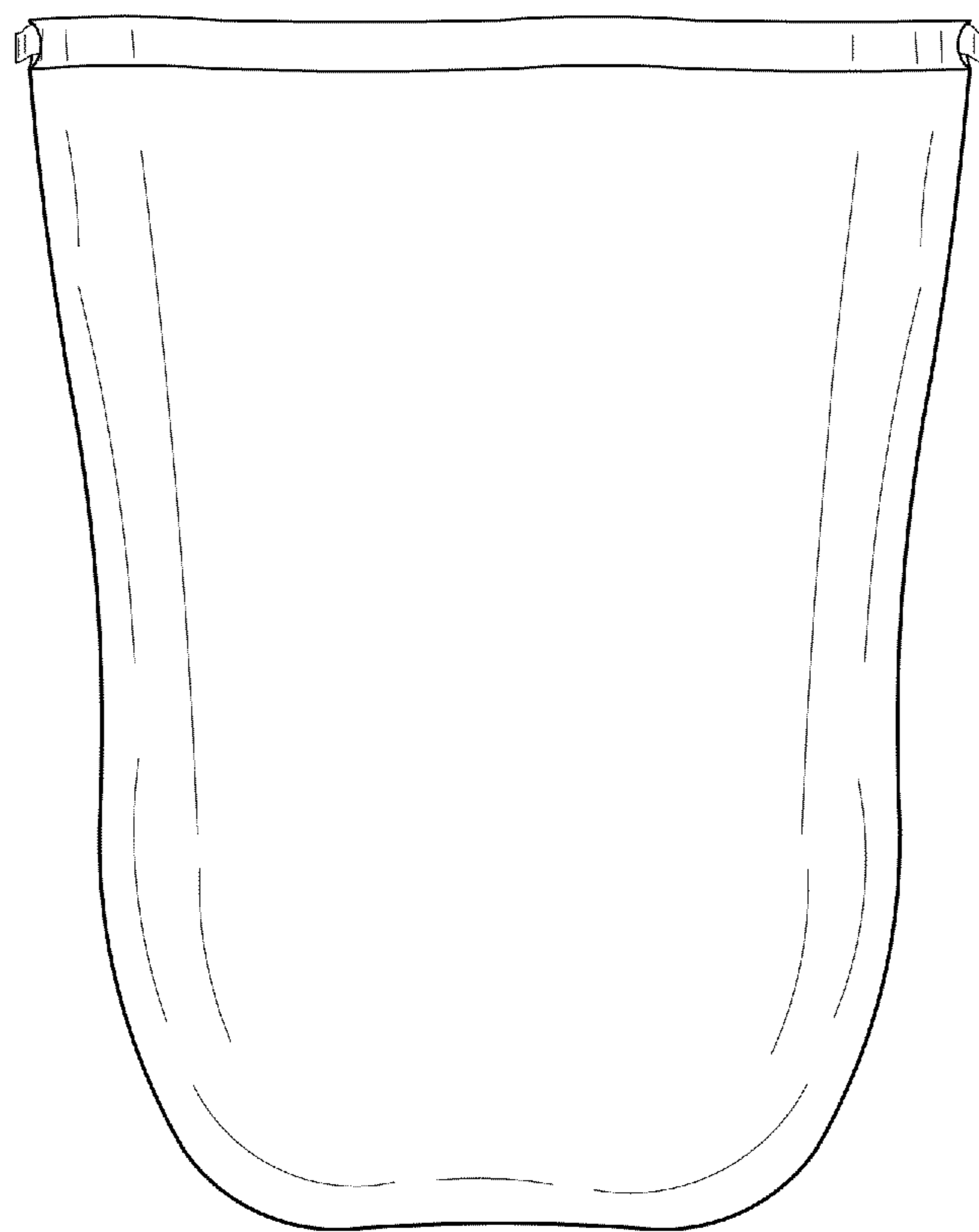

FIG. 3

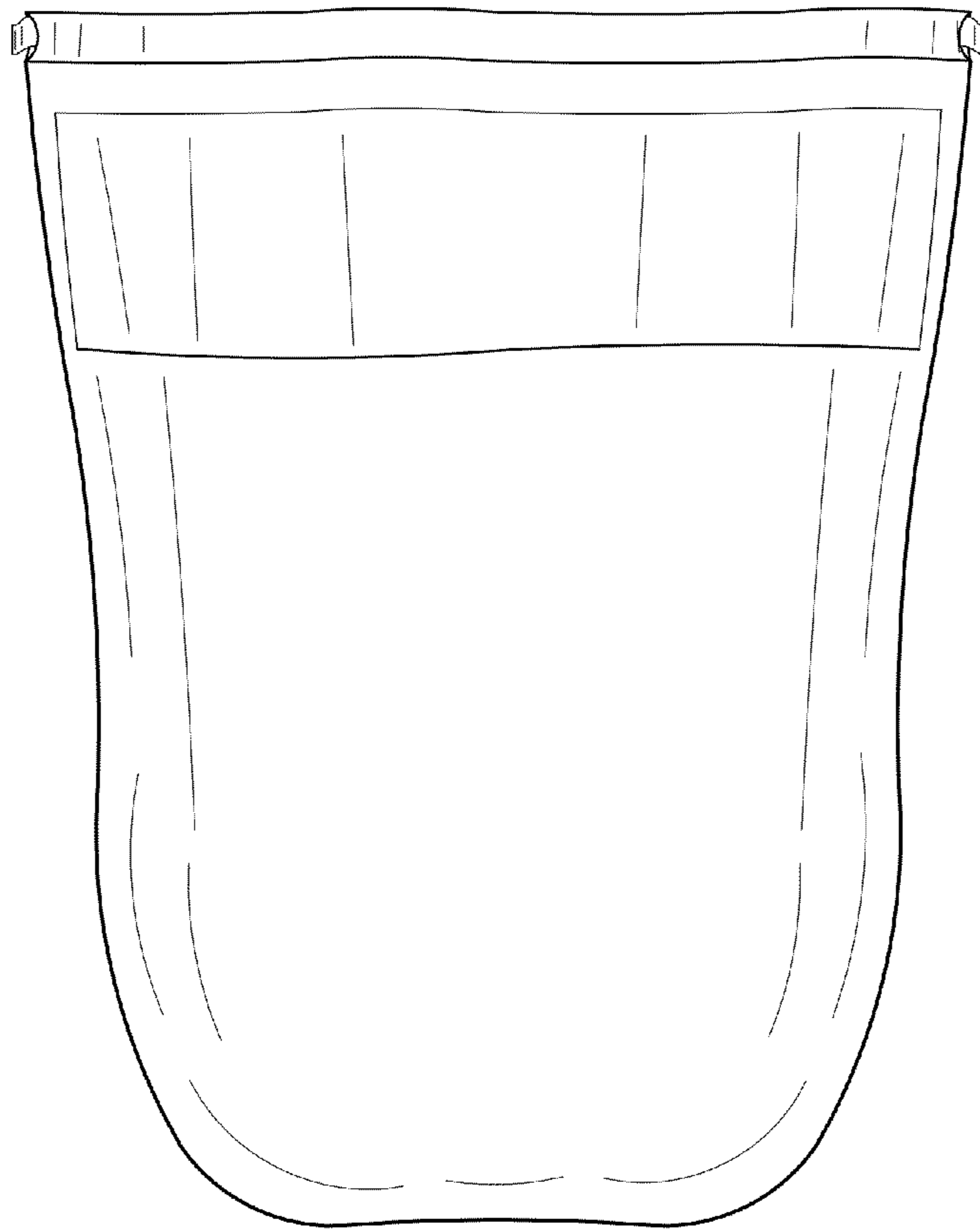

FIG. 4

FIG. 5

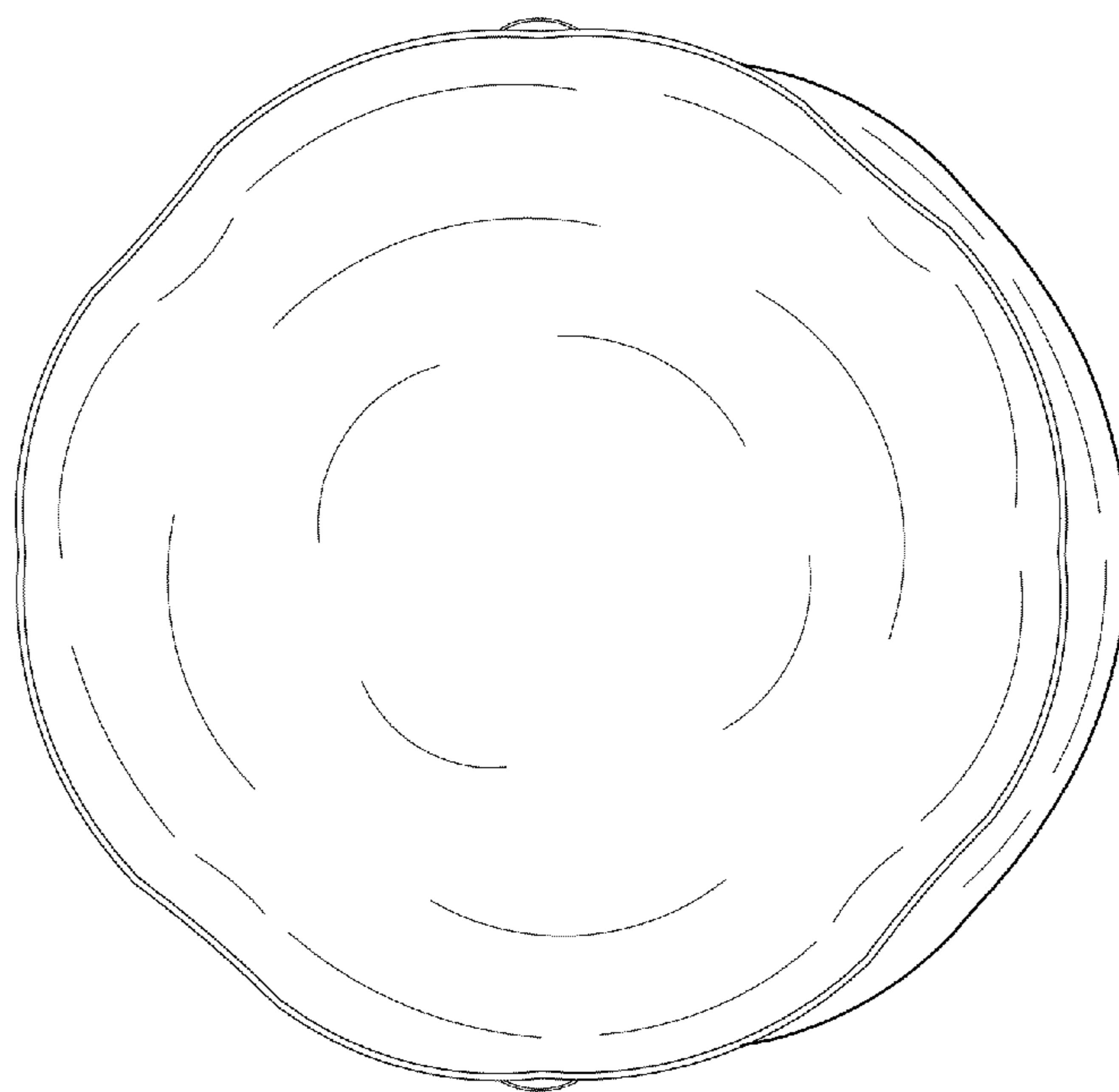
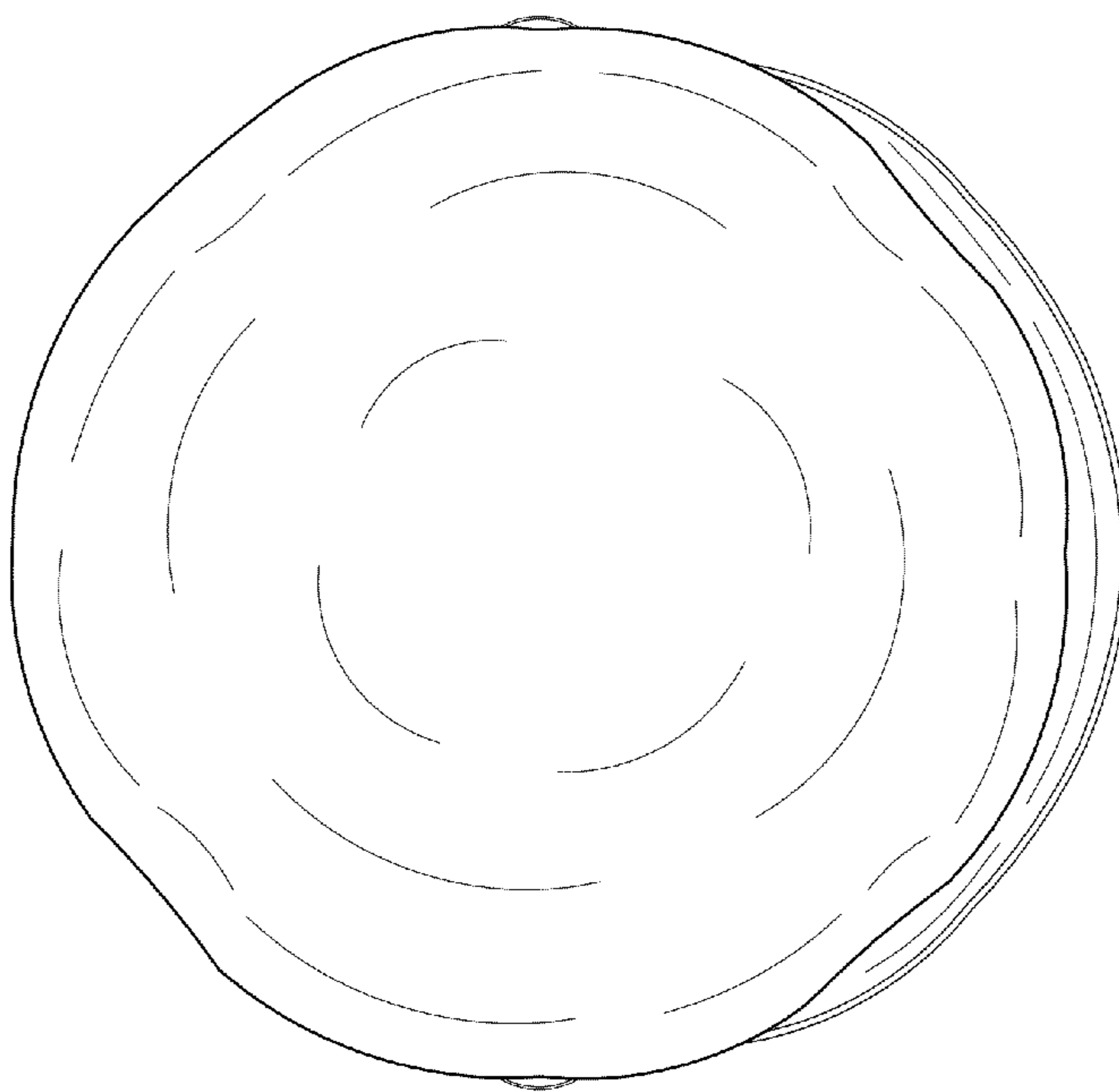

FIG. 6



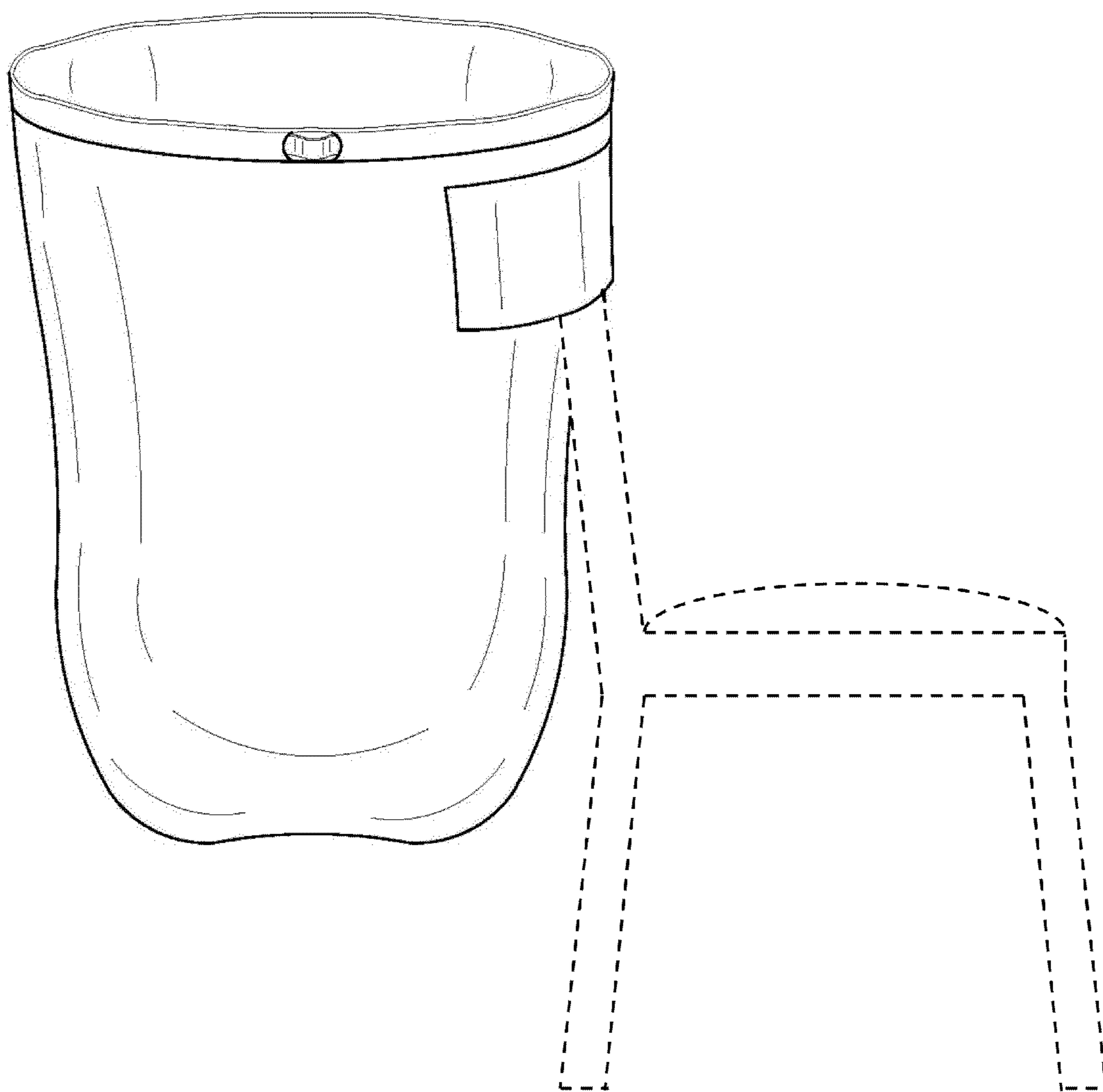

FIG. 7