



US00D715656S

(12) **United States Design Patent**
Herbst

(10) **Patent No.:** **US D715,656 S**
(45) **Date of Patent:** **** Oct. 21, 2014**

(54) **BOTTLE**

(71) Applicant: **RNR IP Holdings, LLC**, Stockton, CA
(US)

(72) Inventor: **Andrew F. Herbst**, Copperopolis, CA
(US)

(73) Assignee: **RNR IP Holdings, LLC**, Stockton, CA
(US)

(**) Term: **14 Years**

(21) Appl. No.: **29/453,937**

(22) Filed: **May 3, 2013**

(51) **LOC (10) Cl.** **09-01**

(52) **U.S. Cl.**
USPC **D9/665**

(58) **Field of Classification Search**
USPC D3/270–271.3; D9/600, 665; 206/457,
206/527; 215/400; 220/890;
229/116.1–116.2; D7/514–520, 606,
D7/613, 619.2, 623, 628; D17/18
See application file for complete search history.

(56) **References Cited**

U.S. PATENT DOCUMENTS

D440,487 S * 4/2001 Leach D9/665
D440,869 S * 4/2001 Leach D9/665

D499,961 S * 12/2004 Wilson D9/665
D604,179 S * 11/2009 Rodriguez D9/665
D619,476 S * 7/2010 McClellan et al. D9/665
D658,502 S * 5/2012 Strobel et al. D9/665
D680,441 S * 4/2013 Herbst D9/665

* cited by examiner

Primary Examiner — Sandra Morris

(74) *Attorney, Agent, or Firm* — Maier & Maier PLLC

(57) **CLAIM**

The ornamental design for a bottle, as shown and described.

DESCRIPTION

FIG. 1 is a front isometric view of a first embodiment of a bottle, showing my design;
FIG. 2 is a front view thereof;
FIG. 3 is a rear view thereof;
FIG. 4 is a left side view thereof;
FIG. 5 is a right side view thereof;
FIG. 6 is a top view thereof;
FIG. 7 is a bottom view thereof;
FIG. 8 is a front isometric view of a second embodiment of a bottle, the only difference being that the bottle is transparent;
FIG. 9 is a front view thereof;
FIG. 10 is a rear view thereof;
FIG. 11 is a left side view thereof;
FIG. 12 is a right side view thereof;
FIG. 13 is a top view thereof; and,
FIG. 14 is a bottom view thereof.

1 Claim, 8 Drawing Sheets

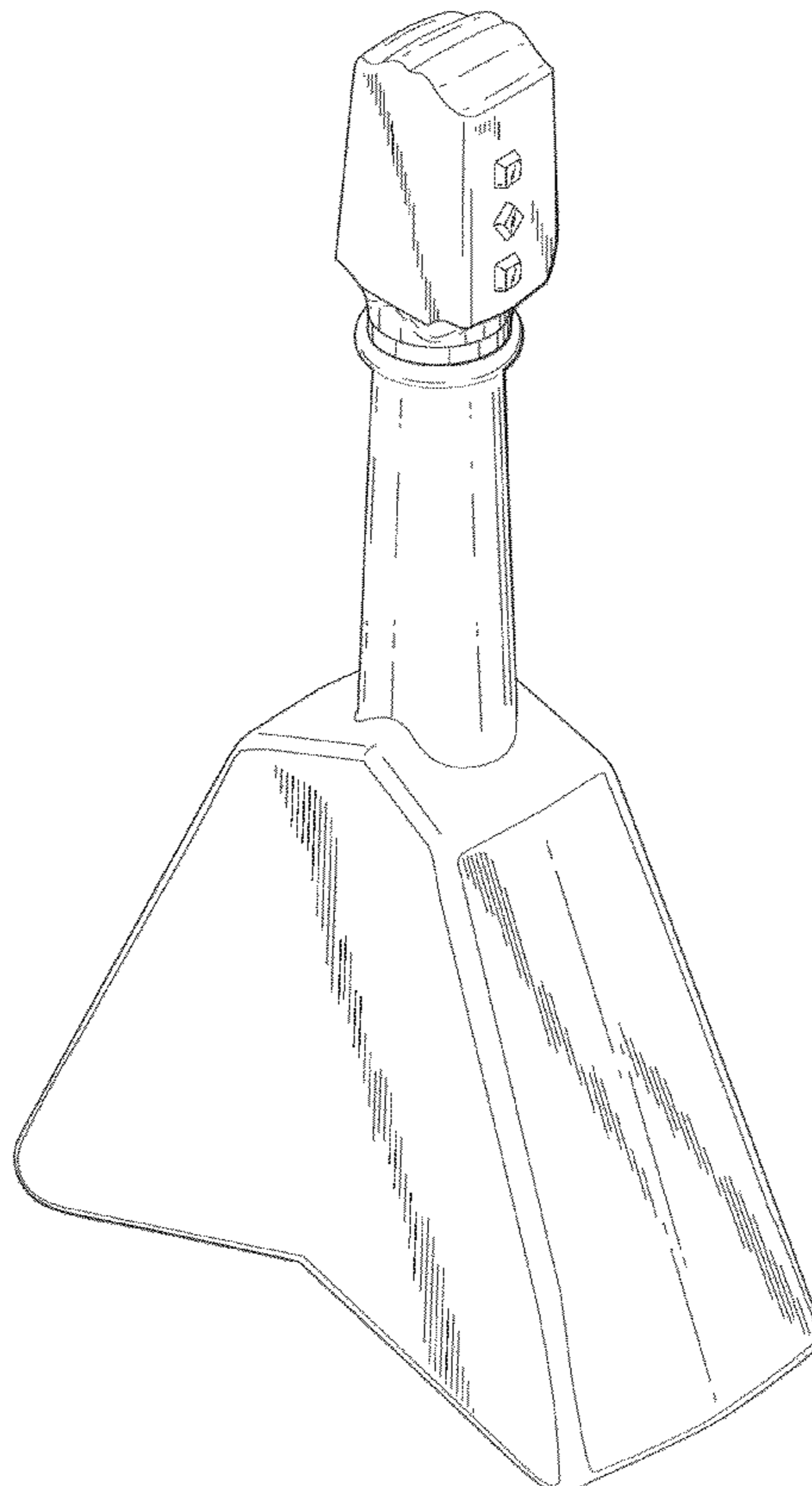

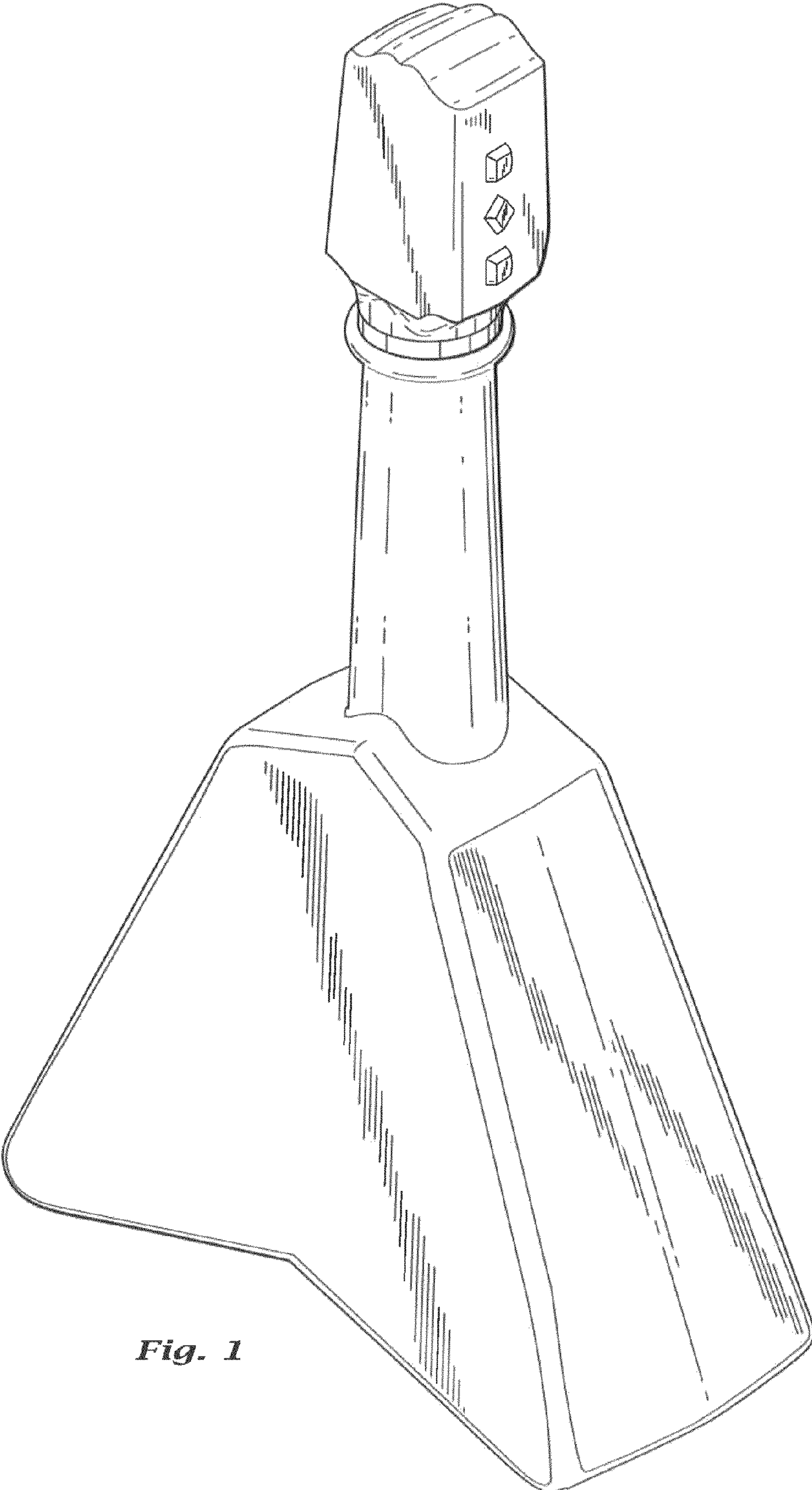
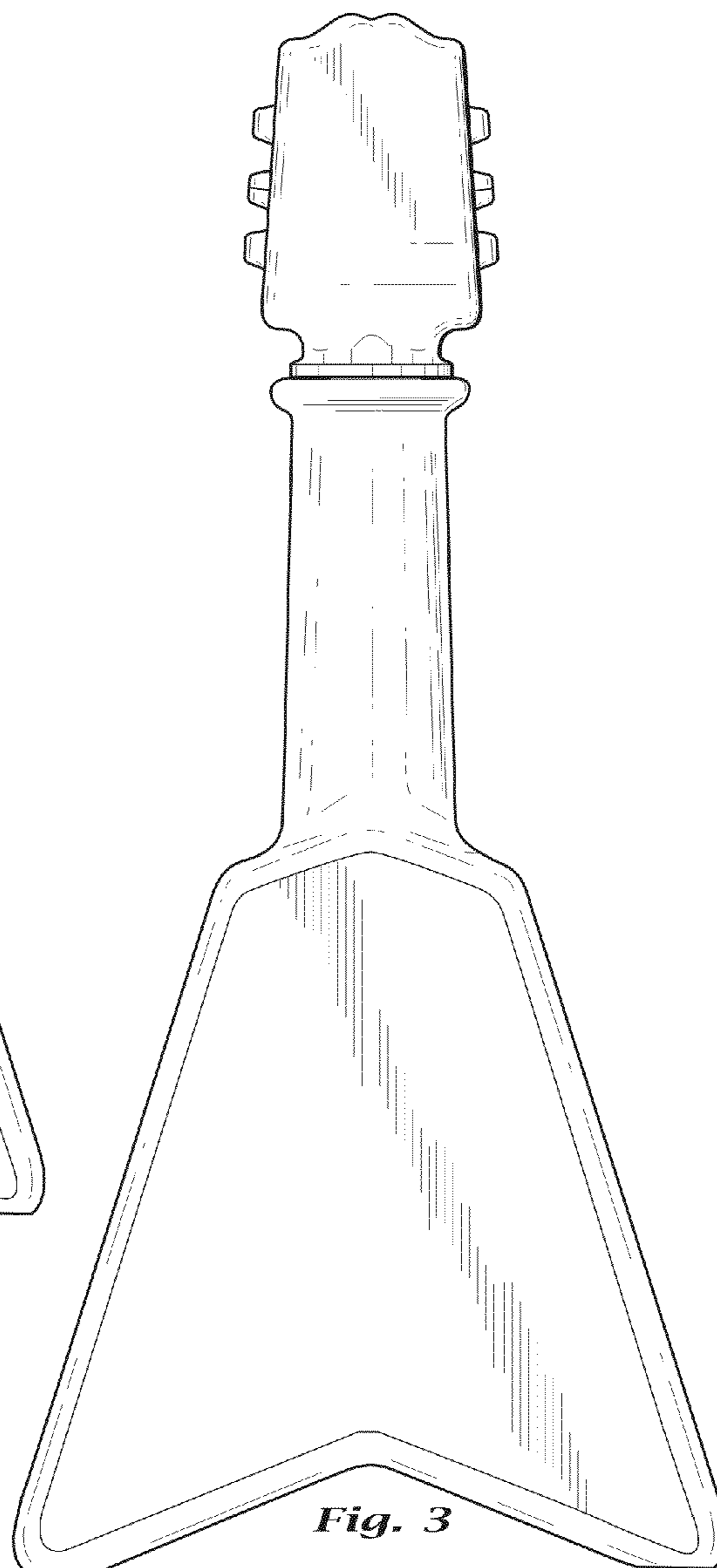
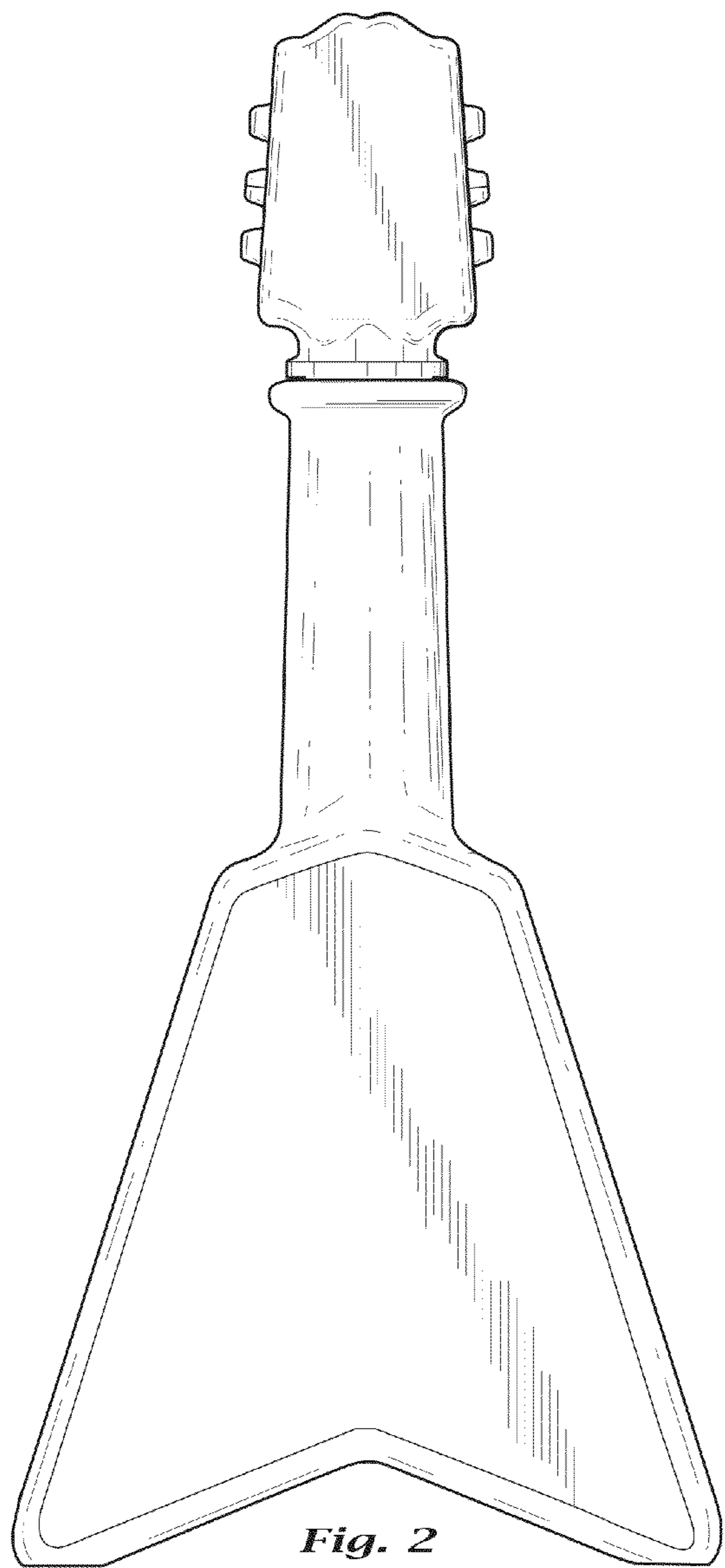

Fig. 1



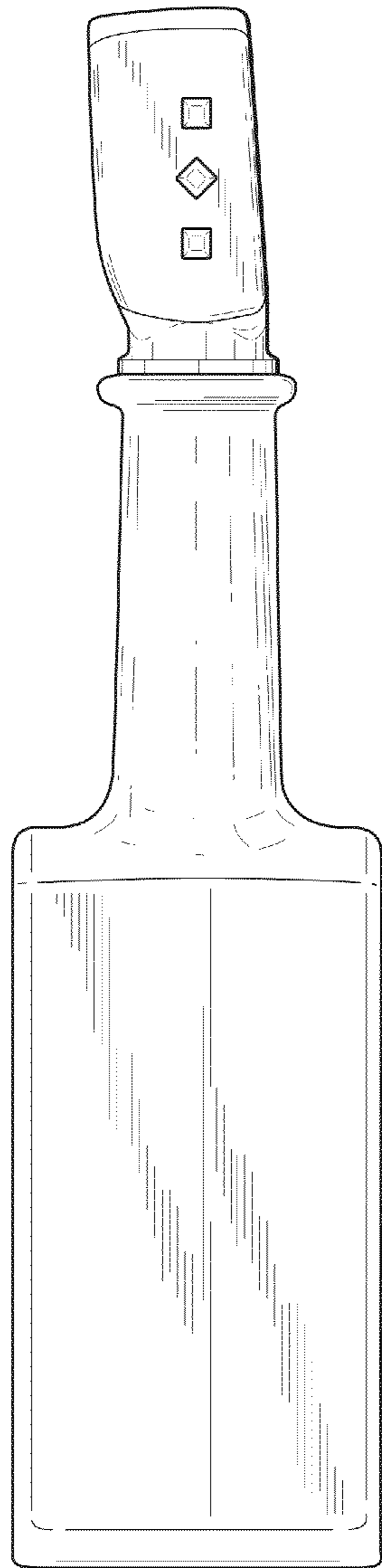

Fig. 4

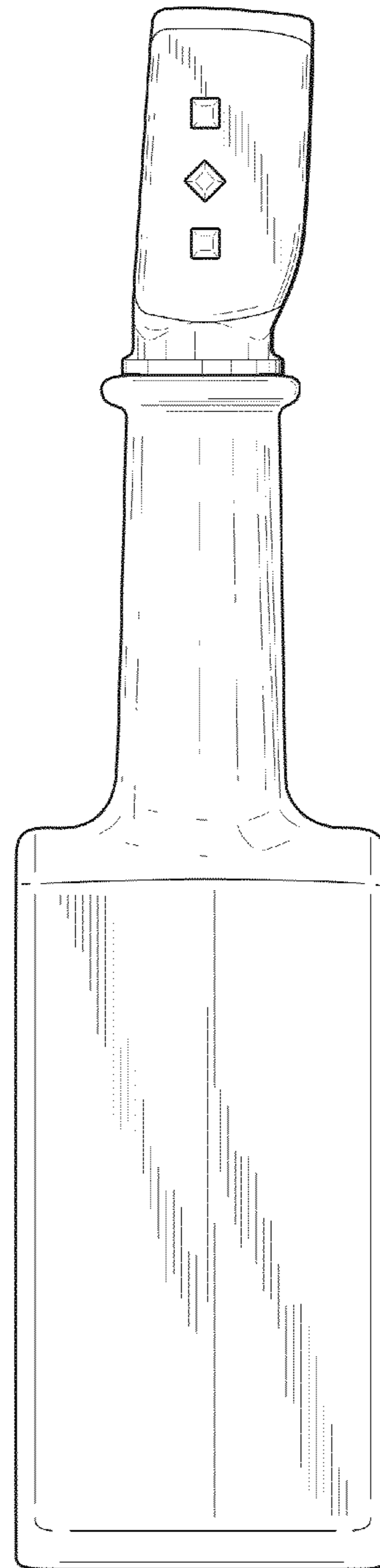

Fig. 5

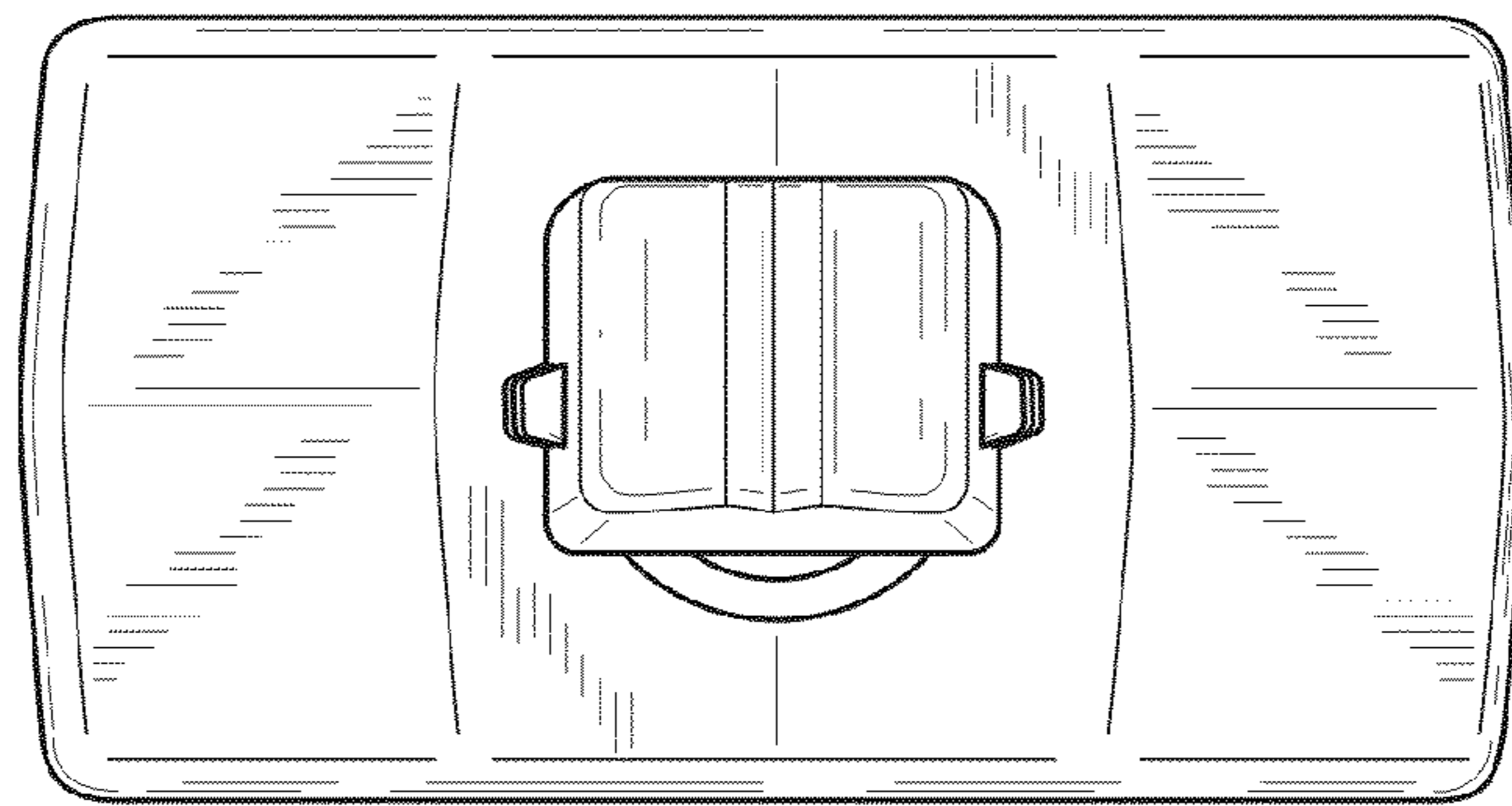

Fig. 6

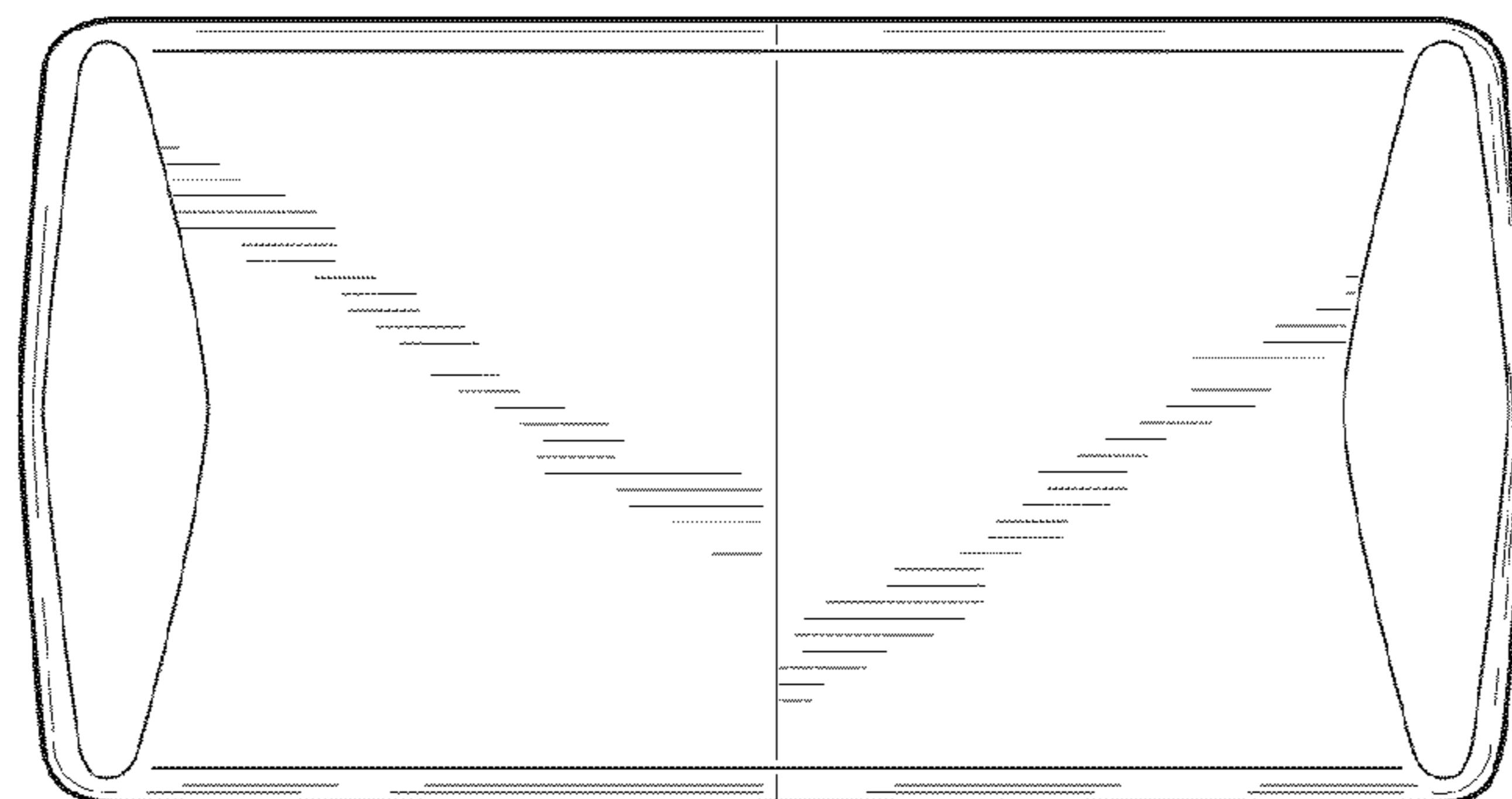
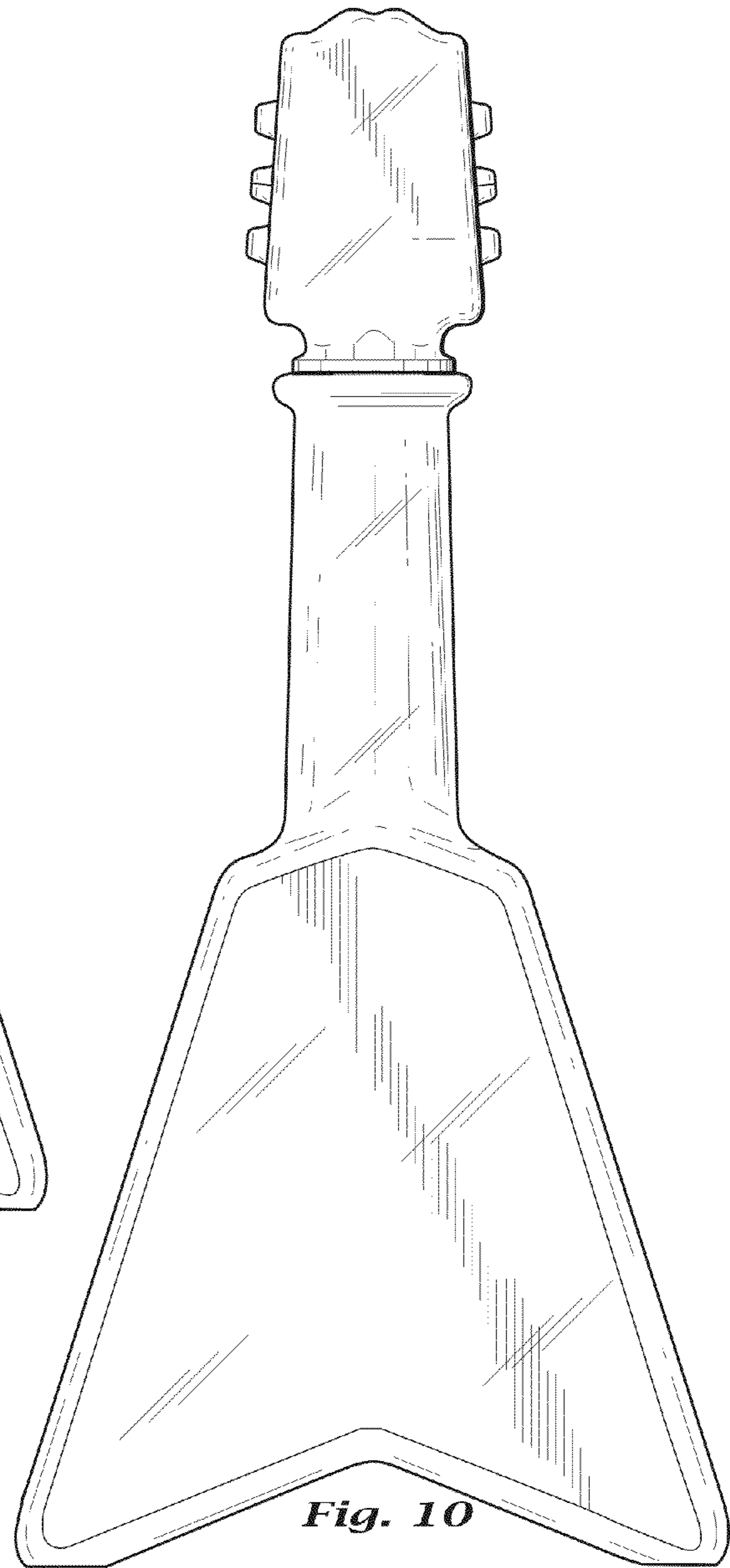
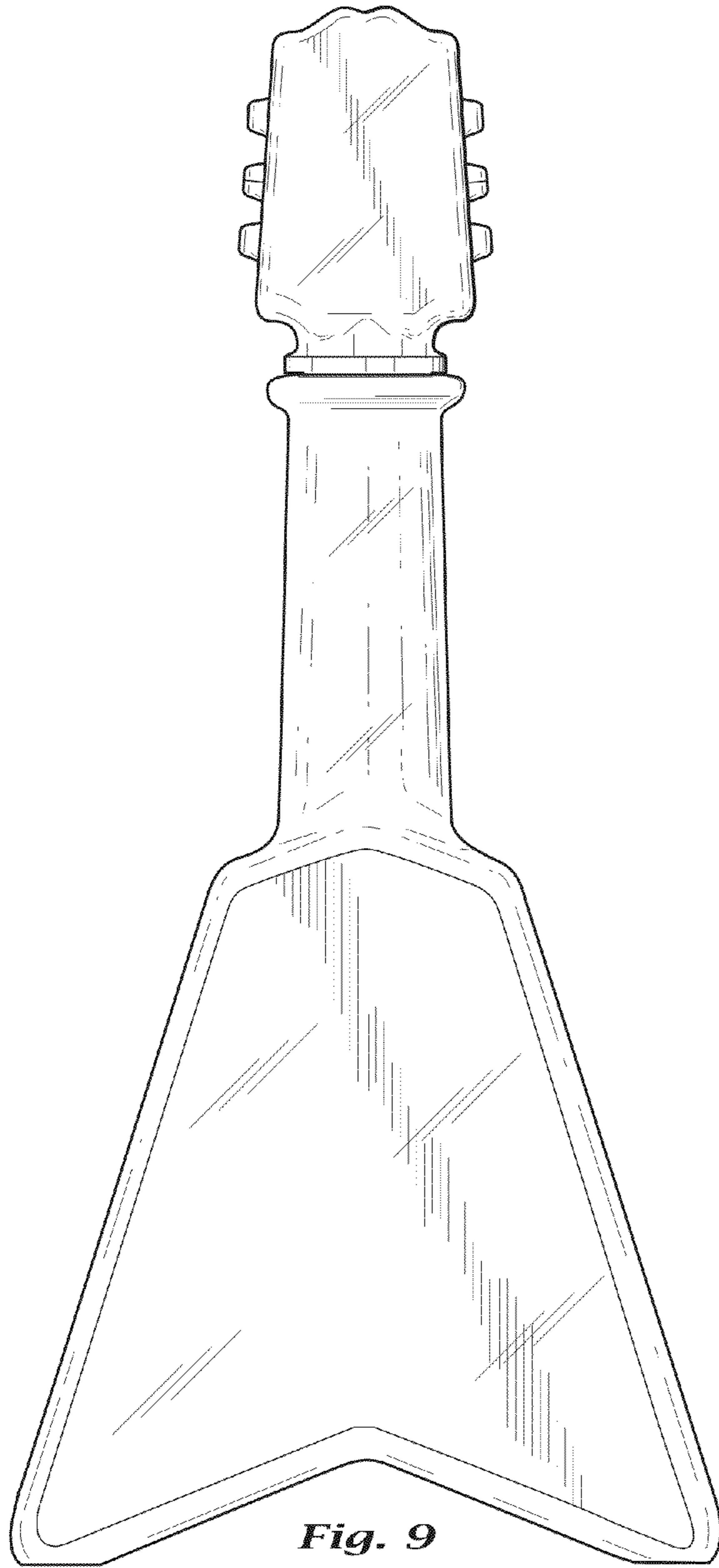

Fig. 7



Fig. 8



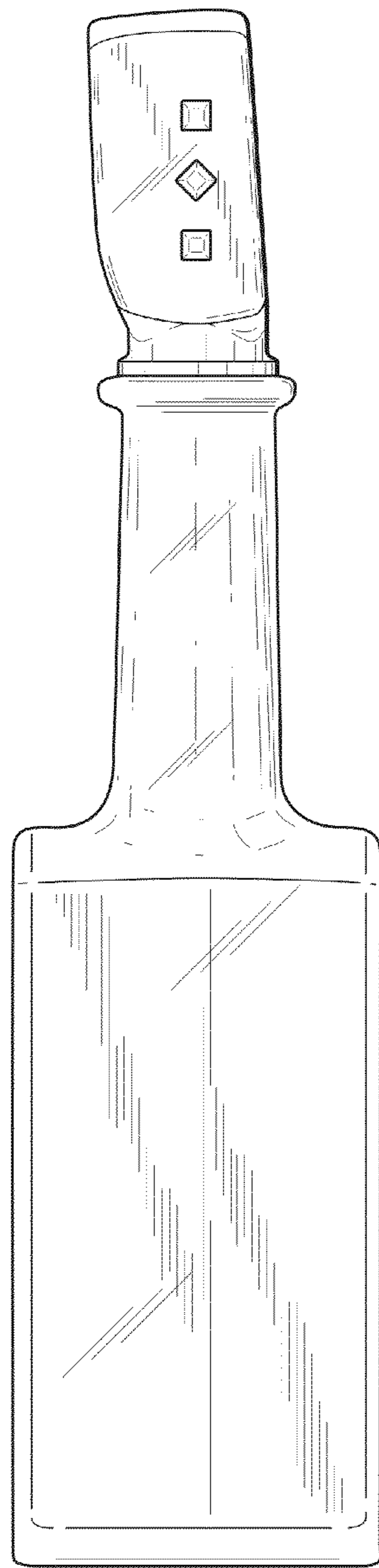

Fig. 11

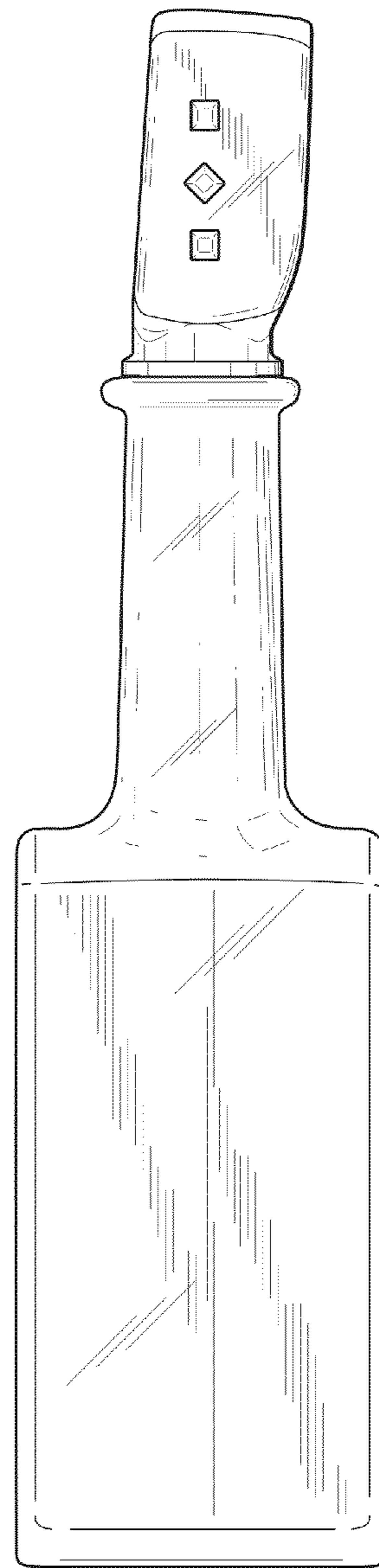

Fig. 12

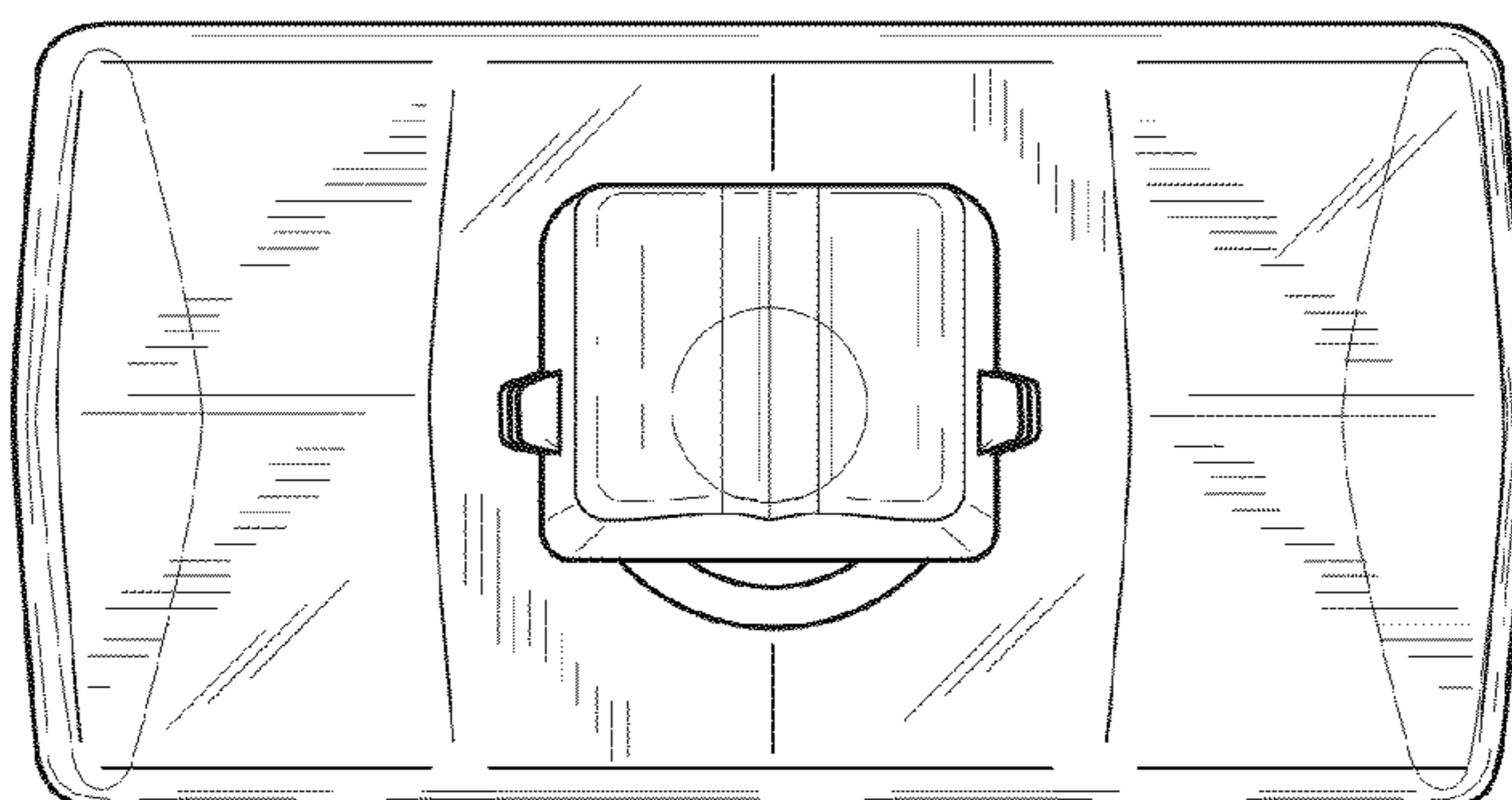

Fig. 13

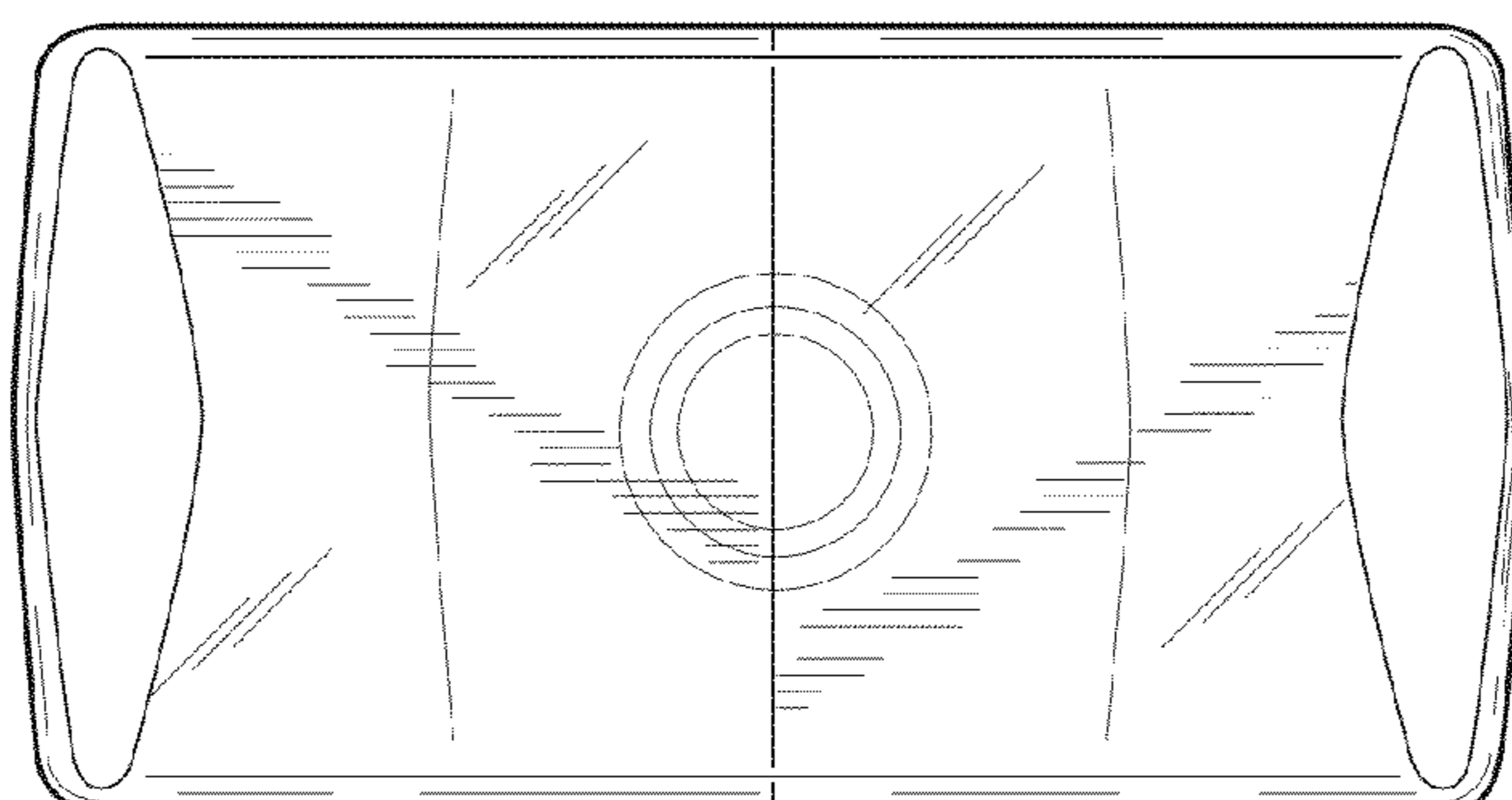

Fig. 14