



US00D715614S

(12) **United States Design Patent**
Teraguchi et al.

(10) **Patent No.:** **US D715,614 S**
(45) **Date of Patent:** **** Oct. 21, 2014**

(54) **SCISSORS**

(71) Applicant: **Kokuyo S&T Co., Ltd.**, Osaka (JP)

(72) Inventors: **Go Teraguchi**, Osaka (JP); **Shigehiro Kawai**, Osaka (JP); **Tsuyoshi Suzuki**, Osaka (JP); **Takayoshi Higashino**, Osaka (JP)

(73) Assignee: **Kokuyo S&T Co., Ltd.**, Osaka (JP)

(**) Term: **14 Years**

(21) Appl. No.: **29/468,628**

(22) Filed: **Oct. 1, 2013**

(30) **Foreign Application Priority Data**

Apr. 4, 2013 (JP) 2013-007668

(51) **LOC (10) Cl.** **08-03**

(52) **U.S. Cl.**
USPC **D8/57**

(58) **Field of Classification Search**
CPC B26B 13/00; B26B 13/20; B26B 13/12;
B26B 17/00
USPC D8/4, 5, 51-58, 105, 107; D27/195;
D21/532; 30/131, 195, 229, 194,
30/230-235, 341, 268, 350, 254-258;
7/135, 136; D28/44, 57
See application file for complete search history.

(56) **References Cited**

U.S. PATENT DOCUMENTS

D272,227 S * 1/1984 Linden et al. D8/57
D358,748 S * 5/1995 Ramsey et al. D8/57
6,493,947 B2 * 12/2002 Stokes 30/341
D496,837 S * 10/2004 Tomchak et al. D8/5
7,458,160 B2 * 12/2008 Escobar et al. 30/232

D614,008 S * 4/2010 Hyp D8/57
D623,494 S * 9/2010 Tsai D8/57
D648,996 S * 11/2011 Hanakawa et al. D8/57
D651,491 S * 1/2012 Hanakawa et al. D8/57
D678,021 S * 3/2013 Kanda et al. D8/57
D678,741 S * 3/2013 Ozeki D8/57
D680,840 S * 4/2013 Bhasin D8/57
2010/0263215 A1 * 10/2010 Hanakawa 30/244

FOREIGN PATENT DOCUMENTS

JP 1396151 9/2010

OTHER PUBLICATIONS

Kutsuwa, Inc., Internet print out from http://www.kutsuwa.co.jp/img/pics/00000591_1_1262683558.jpg with translation, dated Aug., 8, 2011, titled "Scissors", Japan, 2 pages.

* cited by examiner

Primary Examiner — Deanna L Pratt

Assistant Examiner — Harold Blackwell, II

(74) *Attorney, Agent, or Firm* — Dennis R. Haszko

(57) **CLAIM**

The ornamental design for scissors, as shown.

DESCRIPTION

FIG. 1 is an enlarged perspective view of the scissors;
FIG. 2 is a front view thereof;
FIG. 3 is a rear view thereof;
FIG. 4 is a plan view thereof;
FIG. 5 bottom view thereof;
FIG. 6 is a right side view thereof;
FIG. 7 is a left side view thereof;
FIG. 8 is an enlarged cross-sectional view taken along line 8-8 of FIG. 2; and,
FIG. 9 is an enlarged cross-sectional view taken along line 9-9 of FIG. 2.

1 Claim, 5 Drawing Sheets

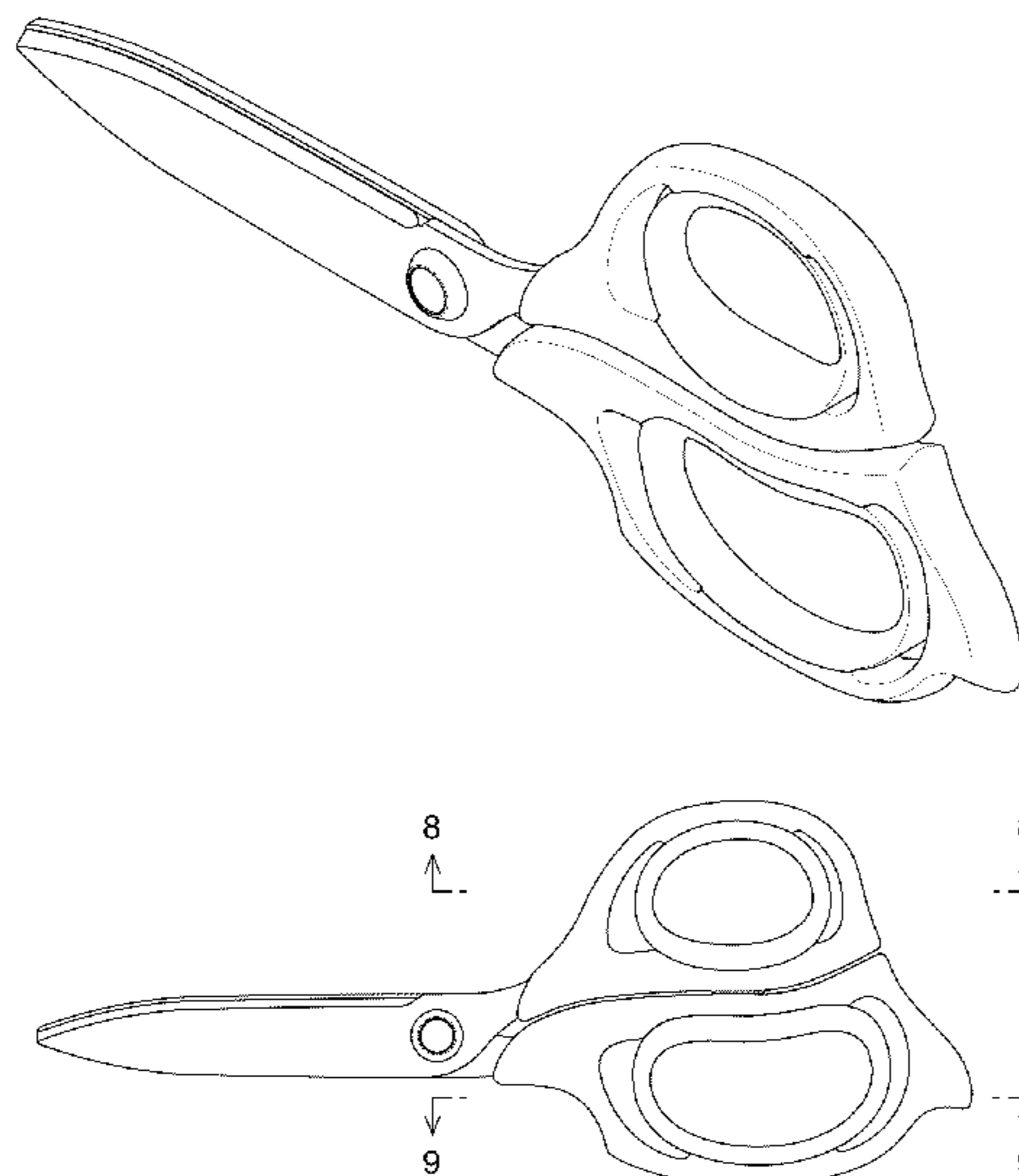

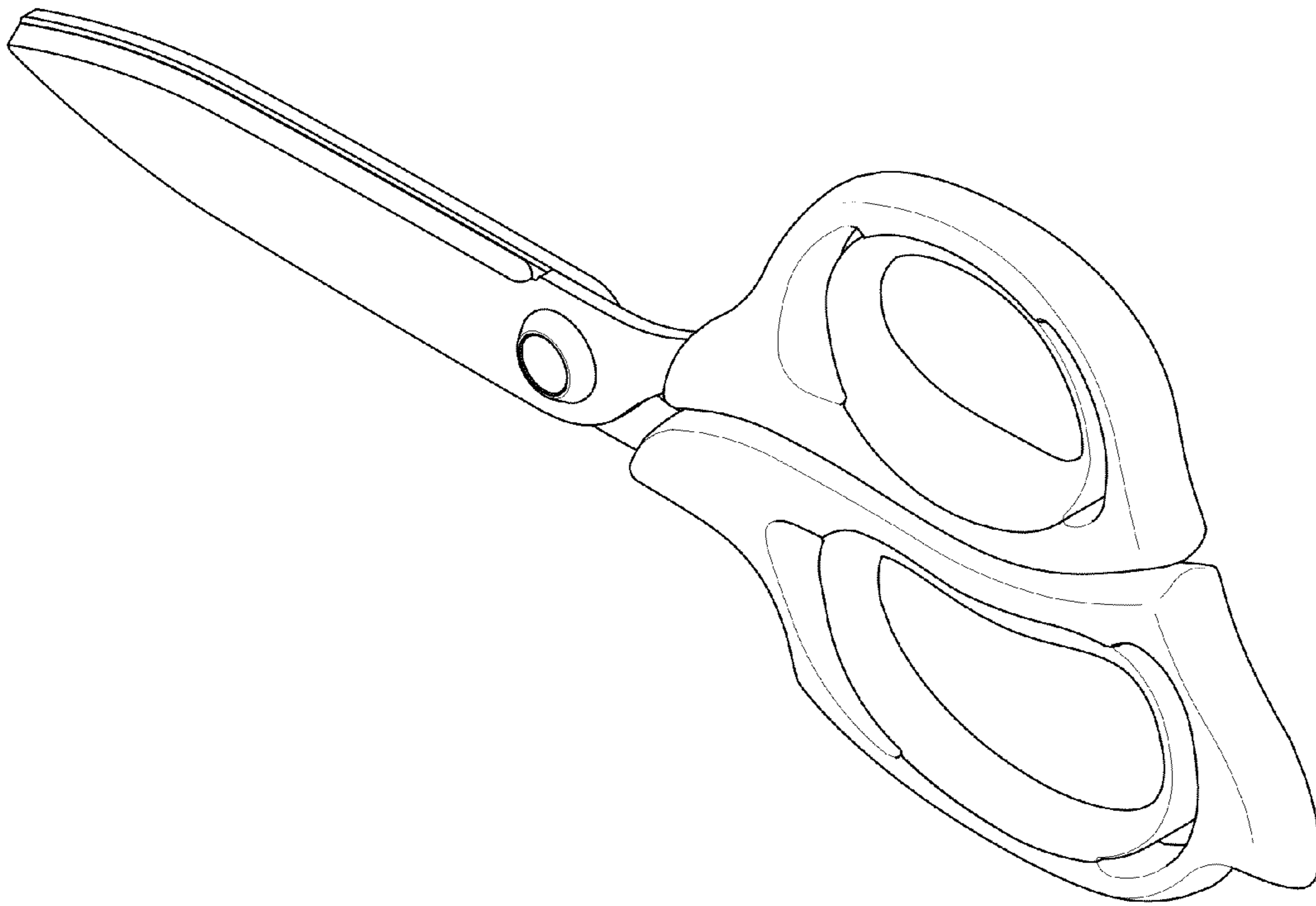

FIG.1

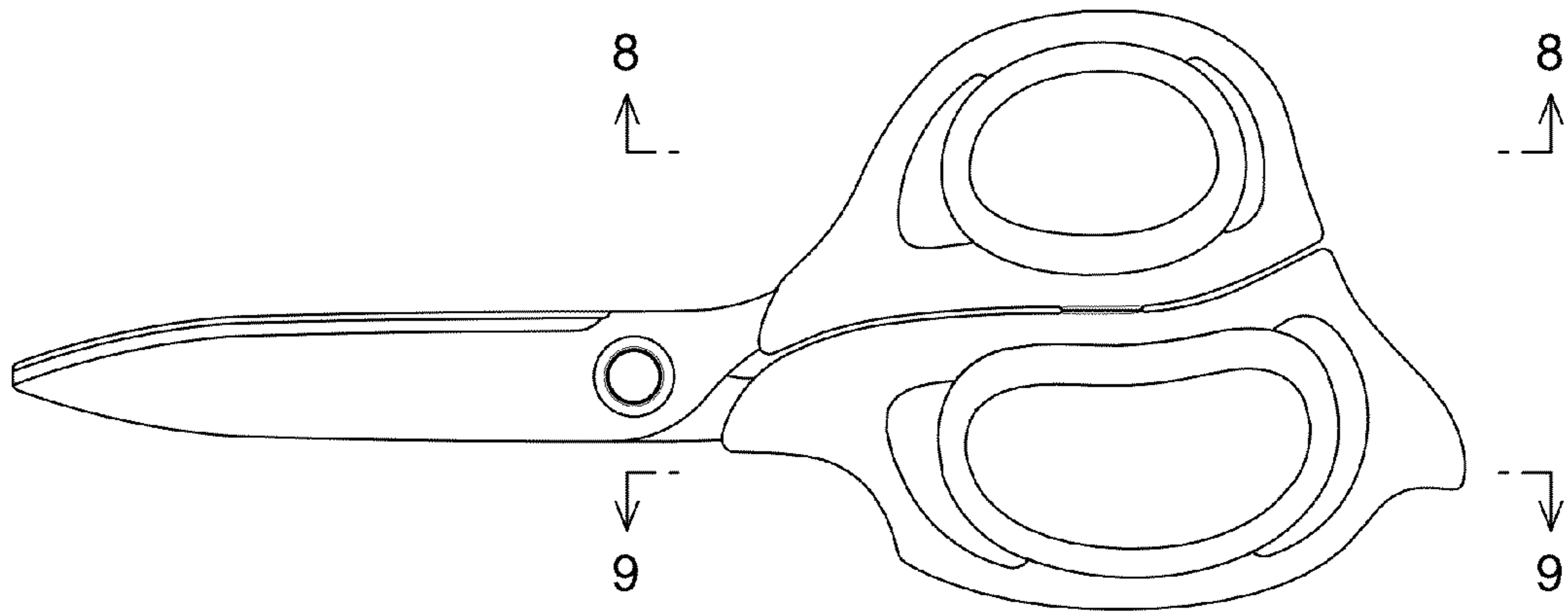

FIG.2

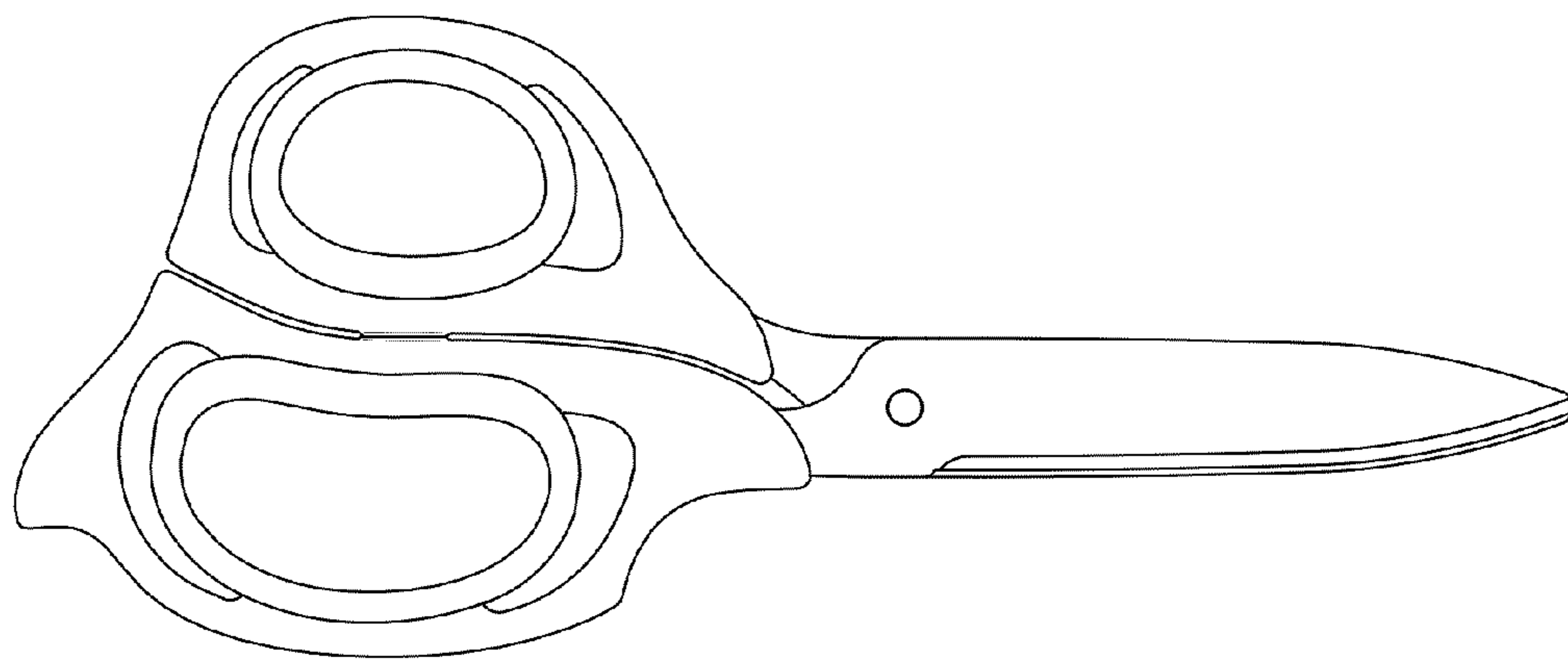

FIG.3

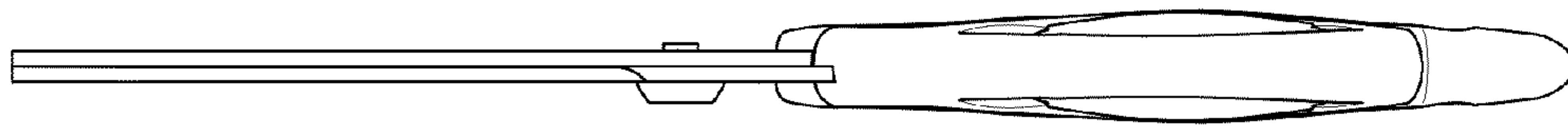

FIG. 4

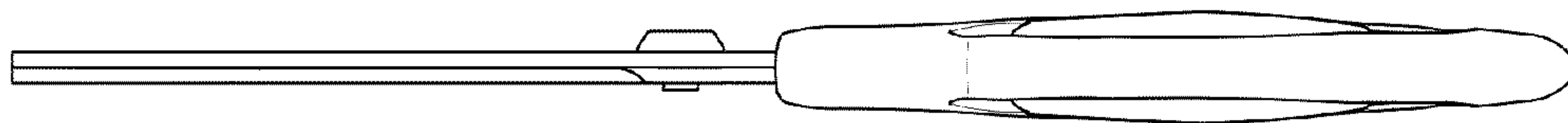

FIG. 5



FIG. 6

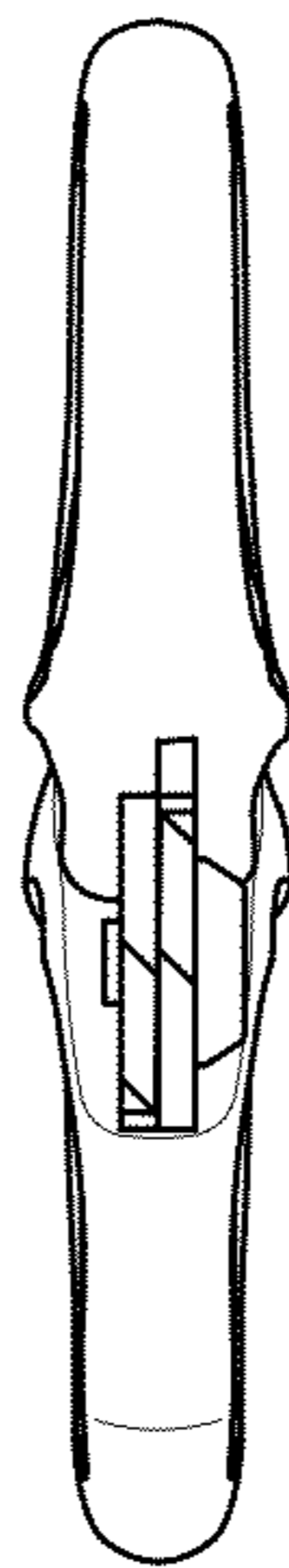

FIG. 7

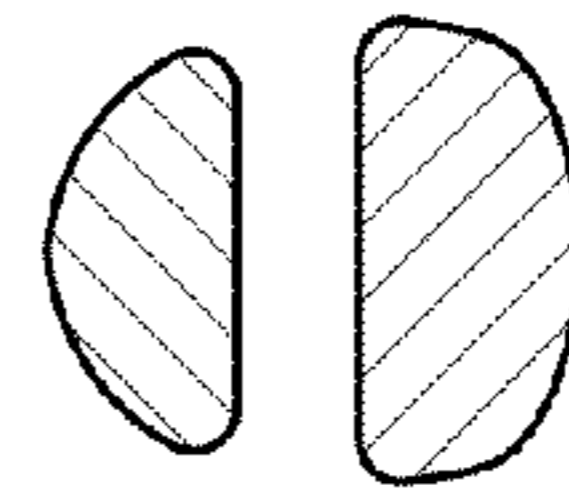
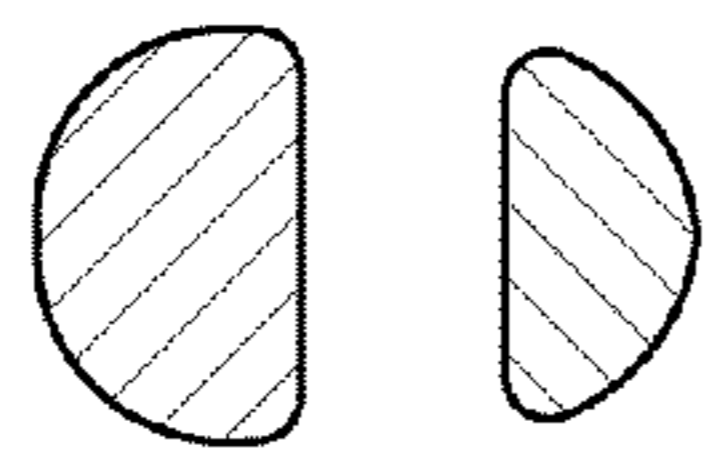

FIG.8

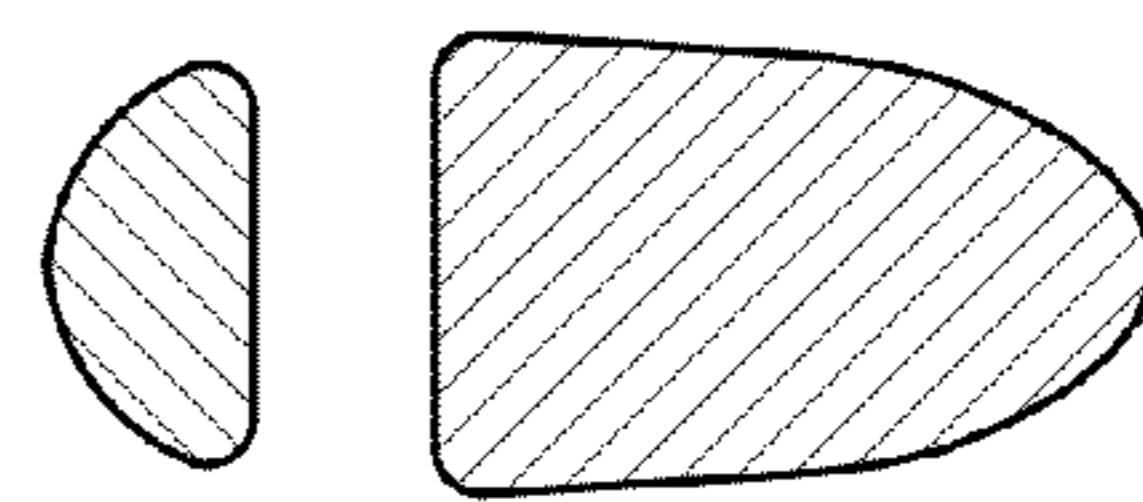
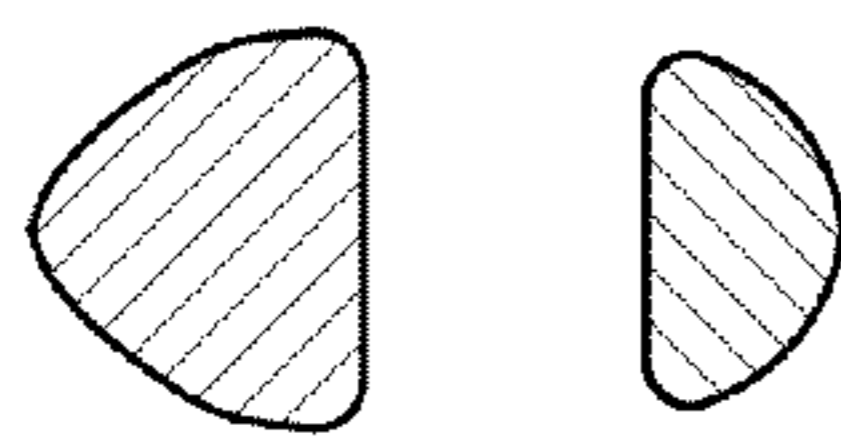

FIG.9