



US00D715573S

(12) **United States Design Patent**
Lloyd et al.

(10) **Patent No.:** **US D715,573 S**
(45) **Date of Patent:** **** Oct. 21, 2014**

- (54) **CHAIR**
- (71) Applicants: **Tom Lloyd**, London (GB); **Luke Pearson**, London (GB)
- (72) Inventors: **Tom Lloyd**, London (GB); **Luke Pearson**, London (GB)
- (73) Assignee: **Howe A/S**, Middelfart (DK)
- (**) Term: **14 Years**
- (21) Appl. No.: **29/452,529**
- (22) Filed: **Apr. 17, 2013**
- (51) **LOC (10) Cl.** **06-01**
- (52) **U.S. Cl.**
USPC **D6/375**
- (58) **Field of Classification Search**
CPC A47C 3/04; A47C 1/124; A47C 3/12;
A47C 4/03; A47C 5/06; A47C 5/12
USPC D6/334-336, 371, 372, 373, 375, 376,
D6/380, 716, 716.1, 716.2, 716.3, 716.4;
297/239, 248, 445.1, 446.1, 452.12,
297/452.14, 452.19, 452.2
See application file for complete search history.

- (56) **References Cited**
U.S. PATENT DOCUMENTS
2,956,618 A * 10/1960 Eames et al. A47C 1/124
3,133,762 A * 5/1964 Newman A47C 1/124
3,146,028 A * 8/1964 Grosfillex A47C 3/12

- 3,256,039 A * 6/1966 Lieberman et al. A47C 3/04
- 3,264,034 A * 8/1966 Lawson A47C 3/12
- 3,284,136 A * 11/1966 Harrison A47C 3/12
- 3,314,718 A * 4/1967 Crandall A47C 3/04
- 3,319,999 A * 5/1967 Lieberman et al. A47C 3/12
- 3,393,941 A * 7/1968 Grosfillex A47C 5/06
- 3,758,155 A * 9/1973 Straits A47C 3/04
- D471,729 S * 3/2003 Glass et al. D6/375
- D544,230 S * 6/2007 Glass et al. D6/375
- D690,147 S * 9/2013 Meyer D6/716

* cited by examiner

Primary Examiner — Mimosa De

(74) *Attorney, Agent, or Firm* — Fross Zelnick Lehrman & Zissu, P.C.; Charles T. J. Weigell, Esq.

(57) **CLAIM**
The ornamental design for a chair, as shown and described.

DESCRIPTION

FIG. 1 is a front perspective view of a chair showing my new design;
FIG. 2 is a right side view of the chair shown in FIG. 1;
FIG. 3 is a left side view of the chair shown in FIG. 1;
FIG. 4 is a front view of the chair shown in FIG. 1;
FIG. 5 is a rear view of the chair shown in FIG. 1;
FIG. 6 is a top view of the chair shown in FIG. 1;
FIG. 7 is a bottom view of the chair shown in FIG. 1; and,
FIG. 8 is a bottom perspective view of the chair shown in FIG. 1.

The broken line showing of the screws, support bars, and portions of the legs in the relevant drawings shows unclaimed subject matter for the design in those drawings.

1 Claim, 8 Drawing Sheets

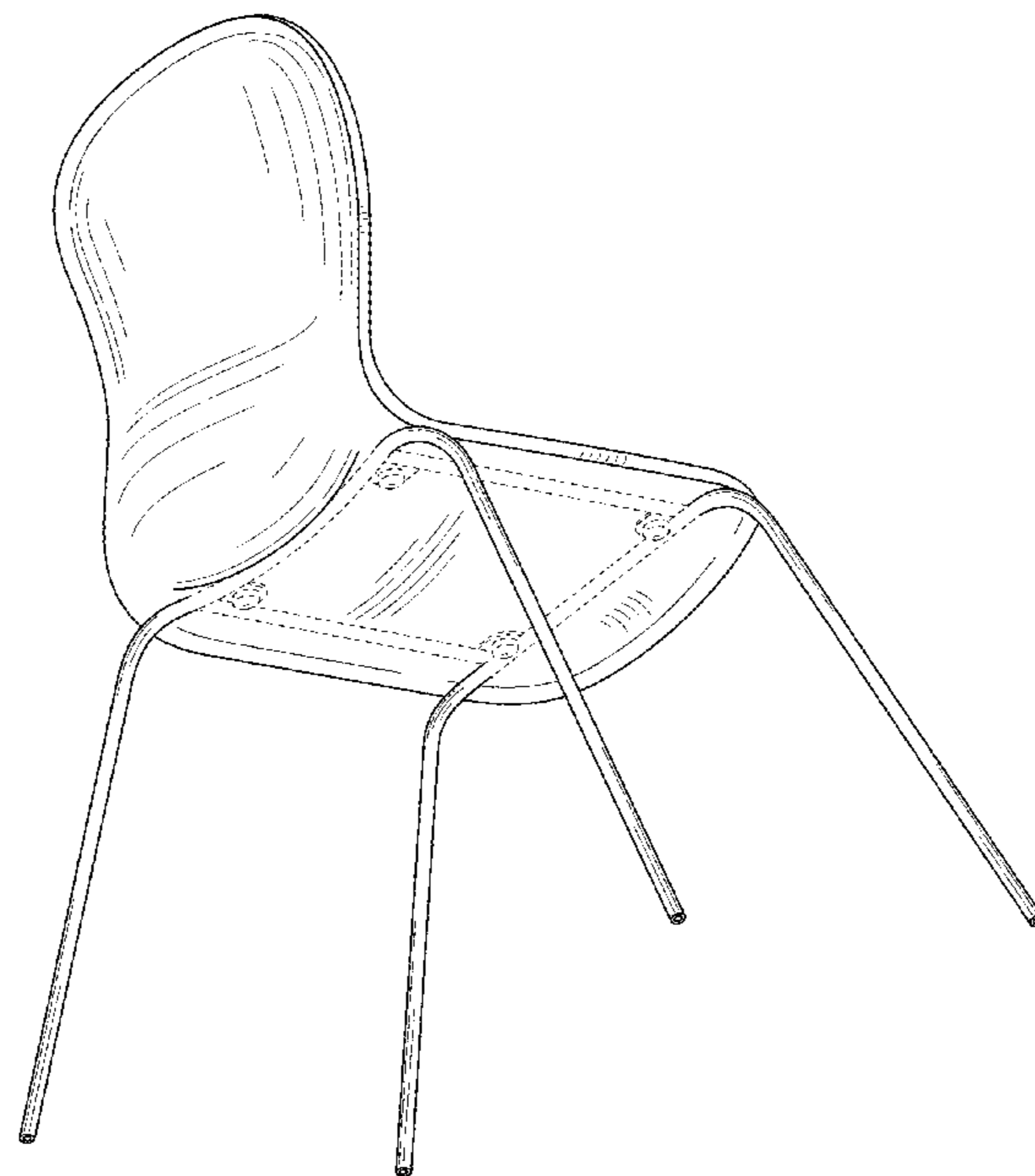
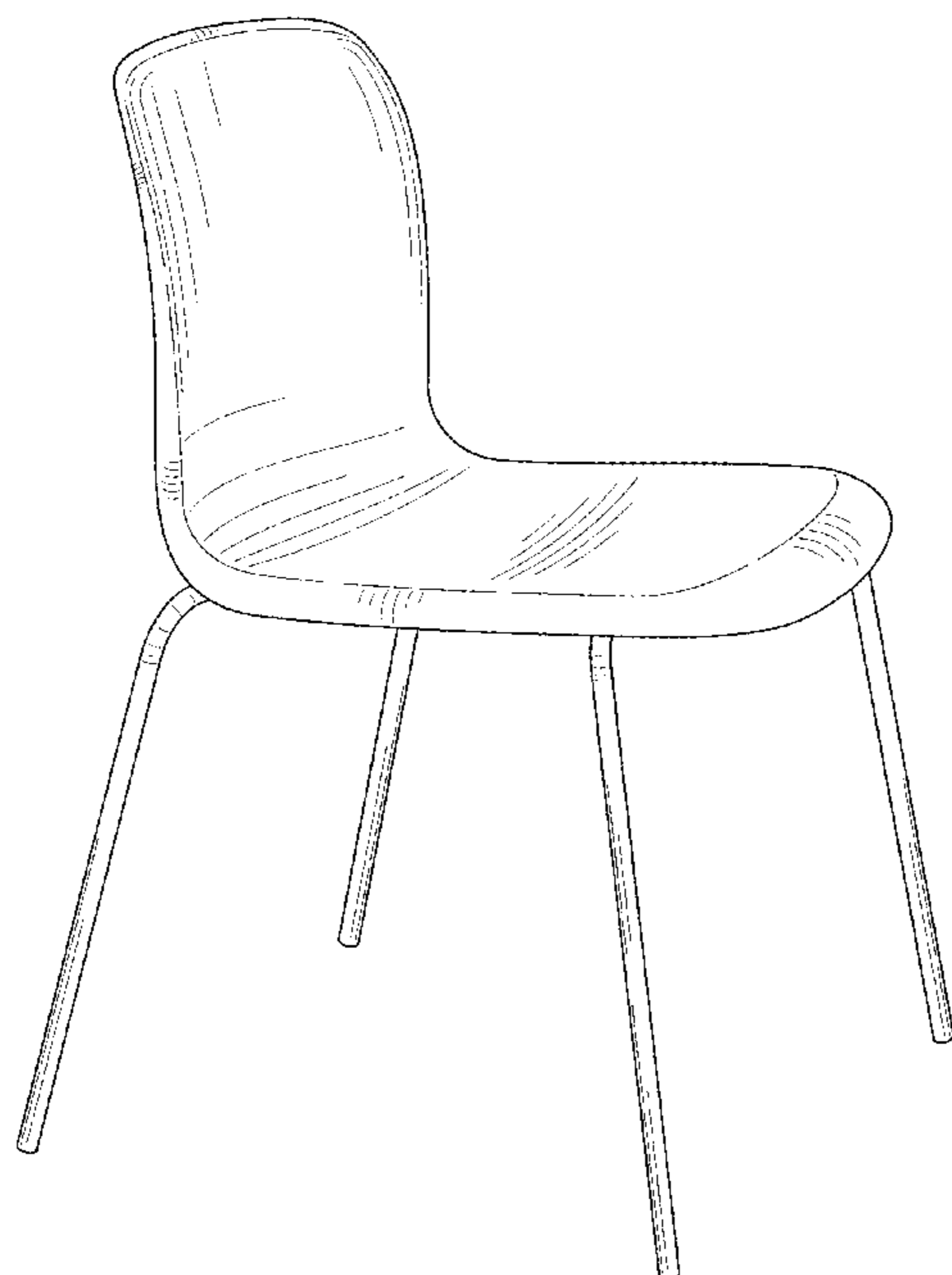

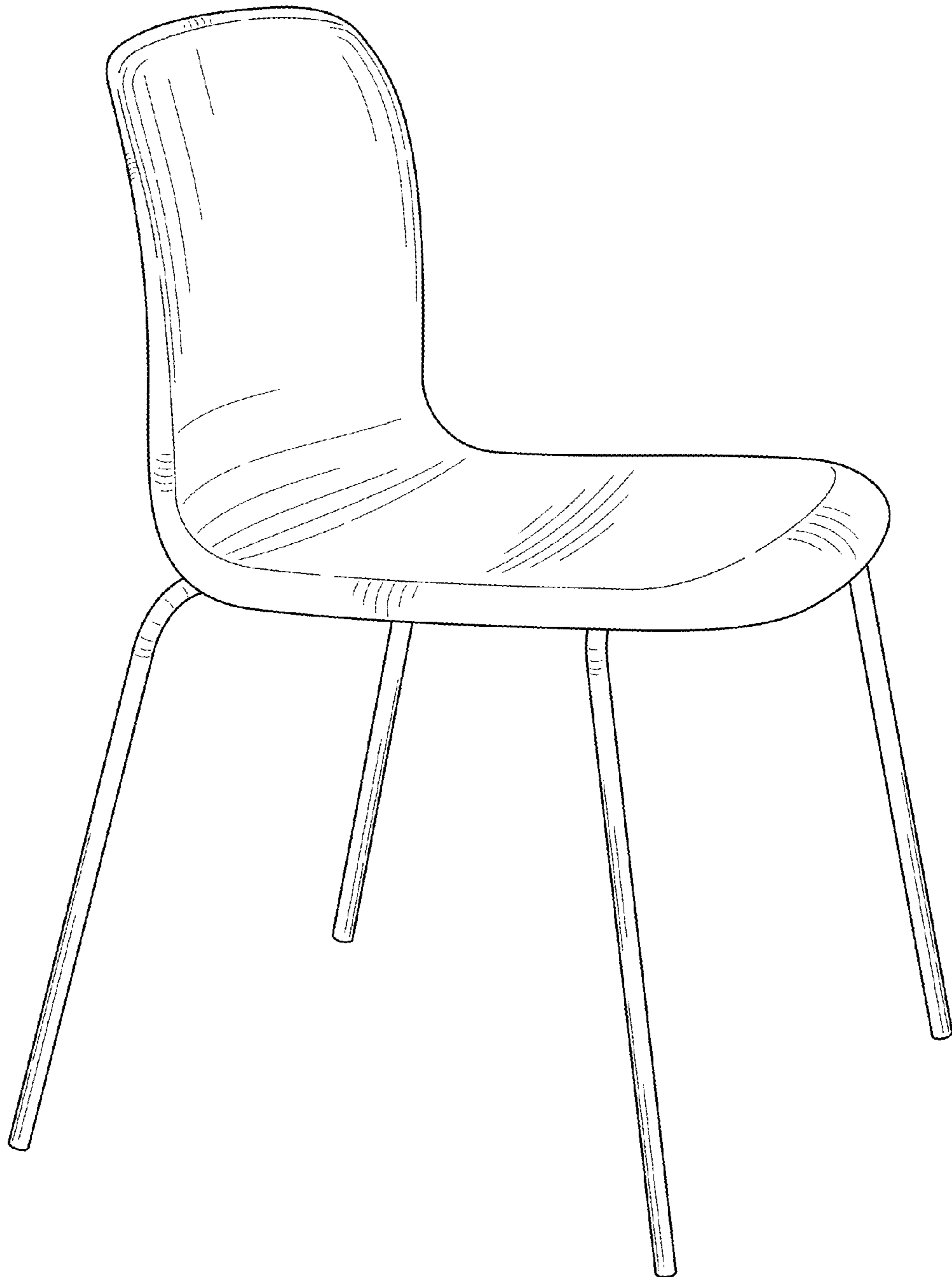

FIG. 1

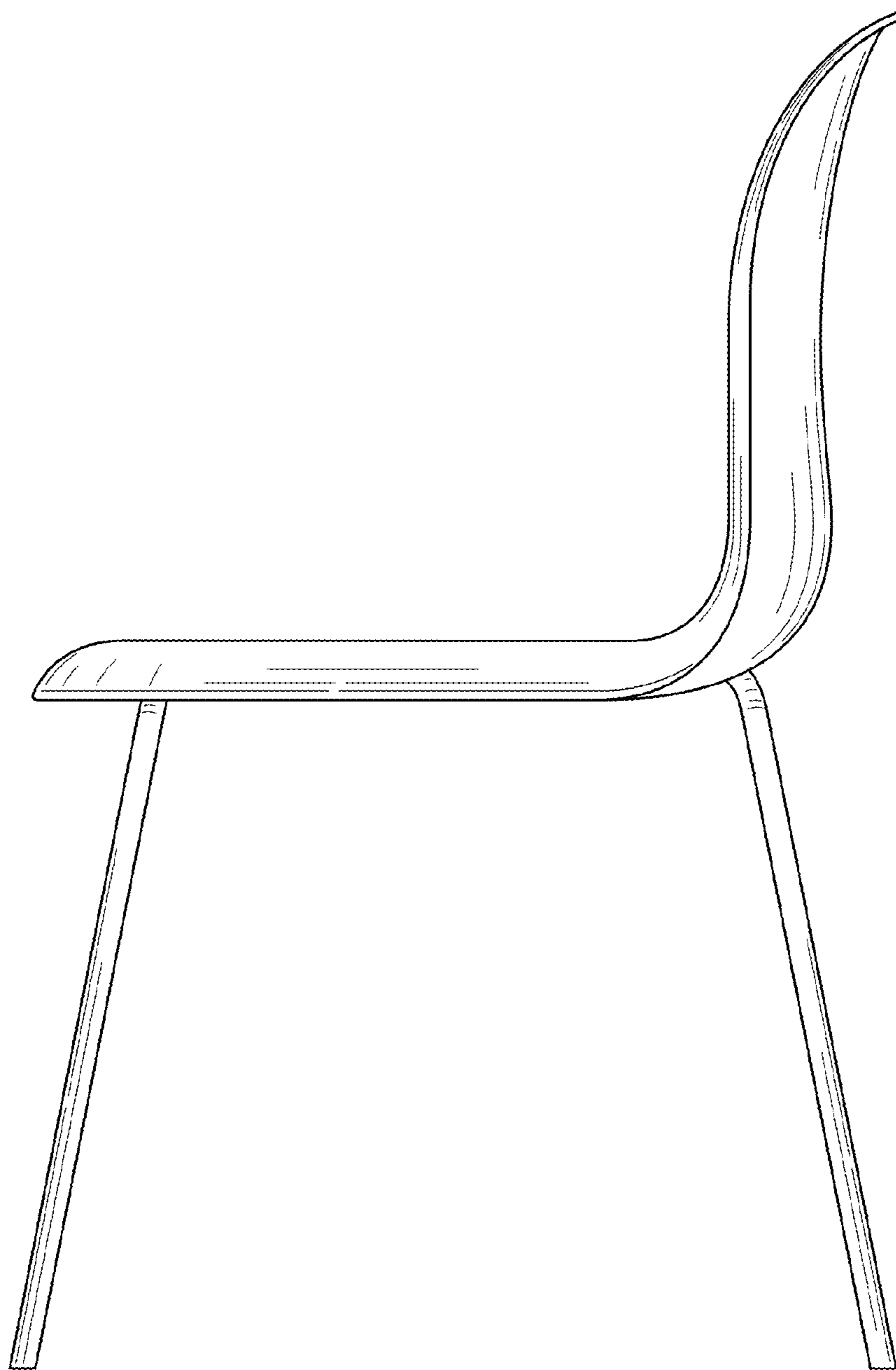

FIG. 2

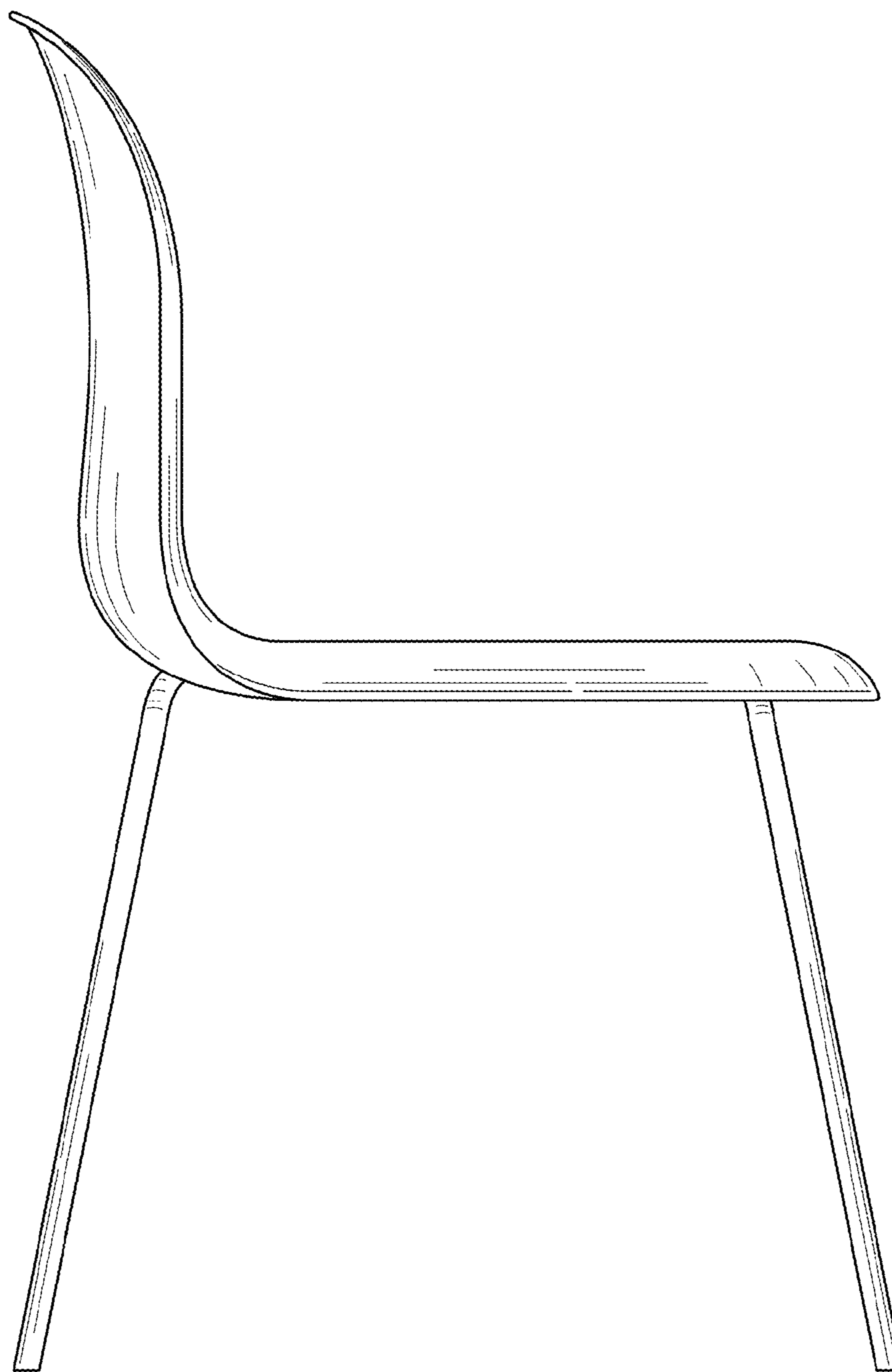

FIG. 3

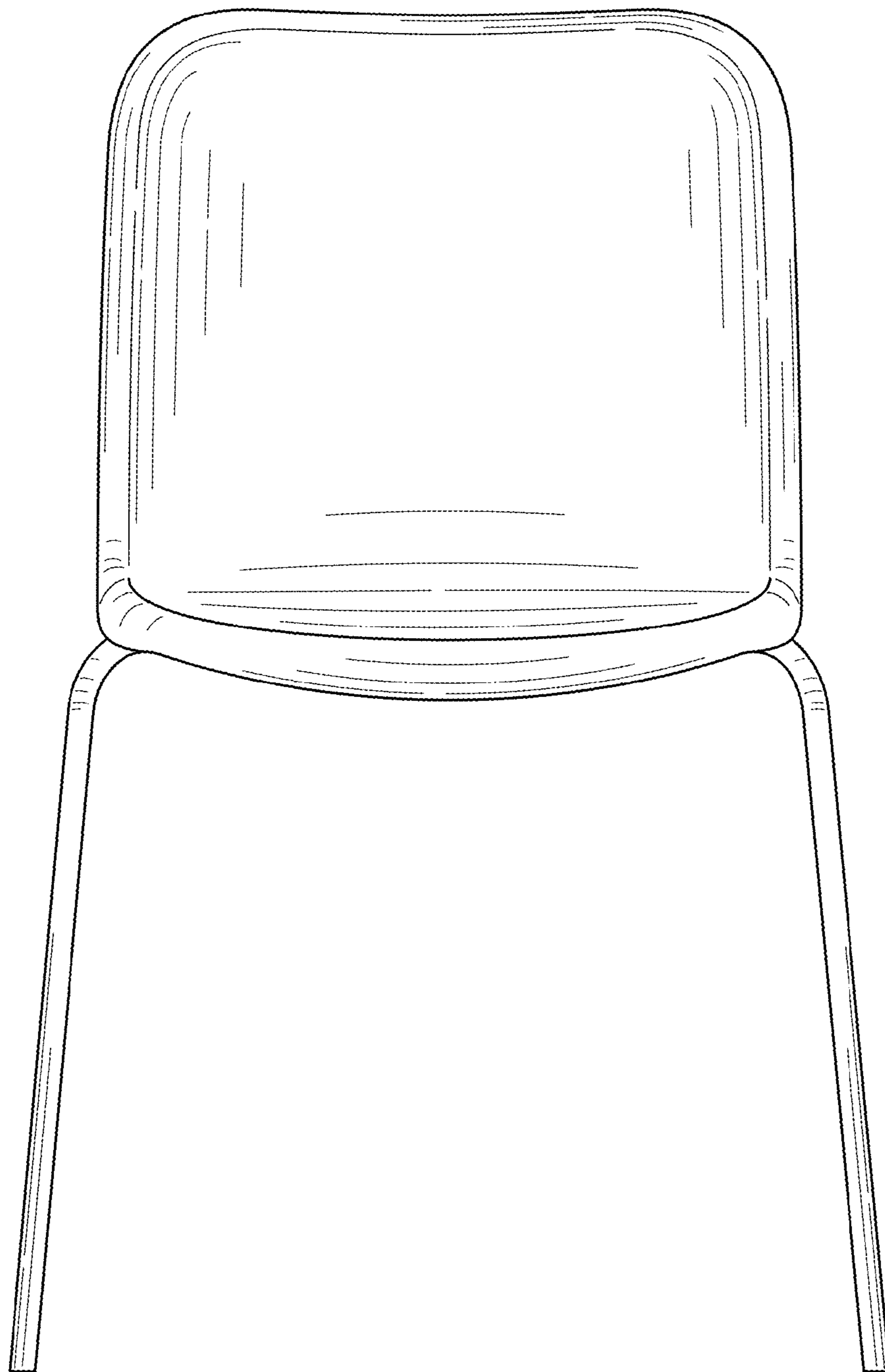

FIG. 4

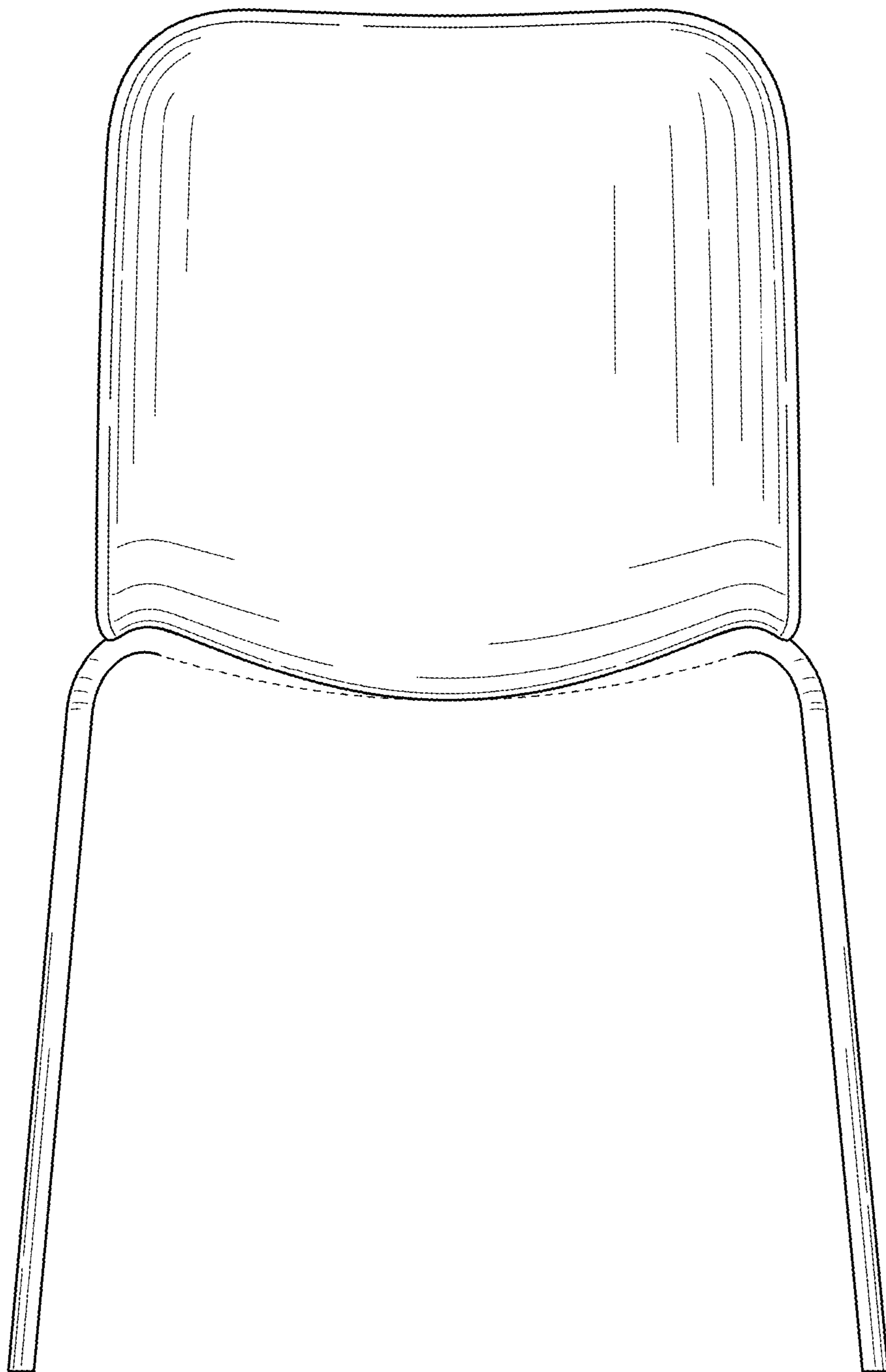

FIG. 5

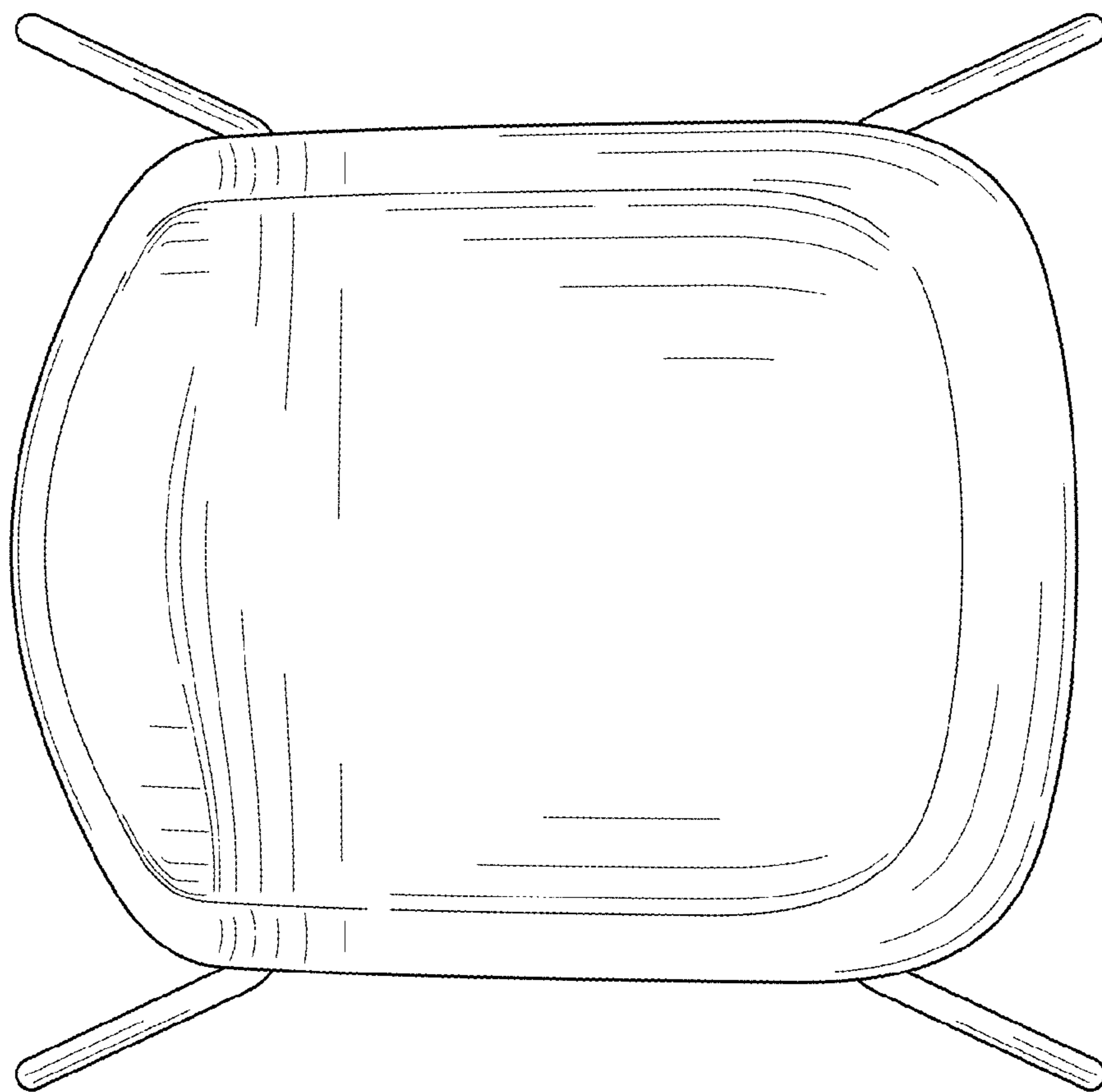

FIG. 6

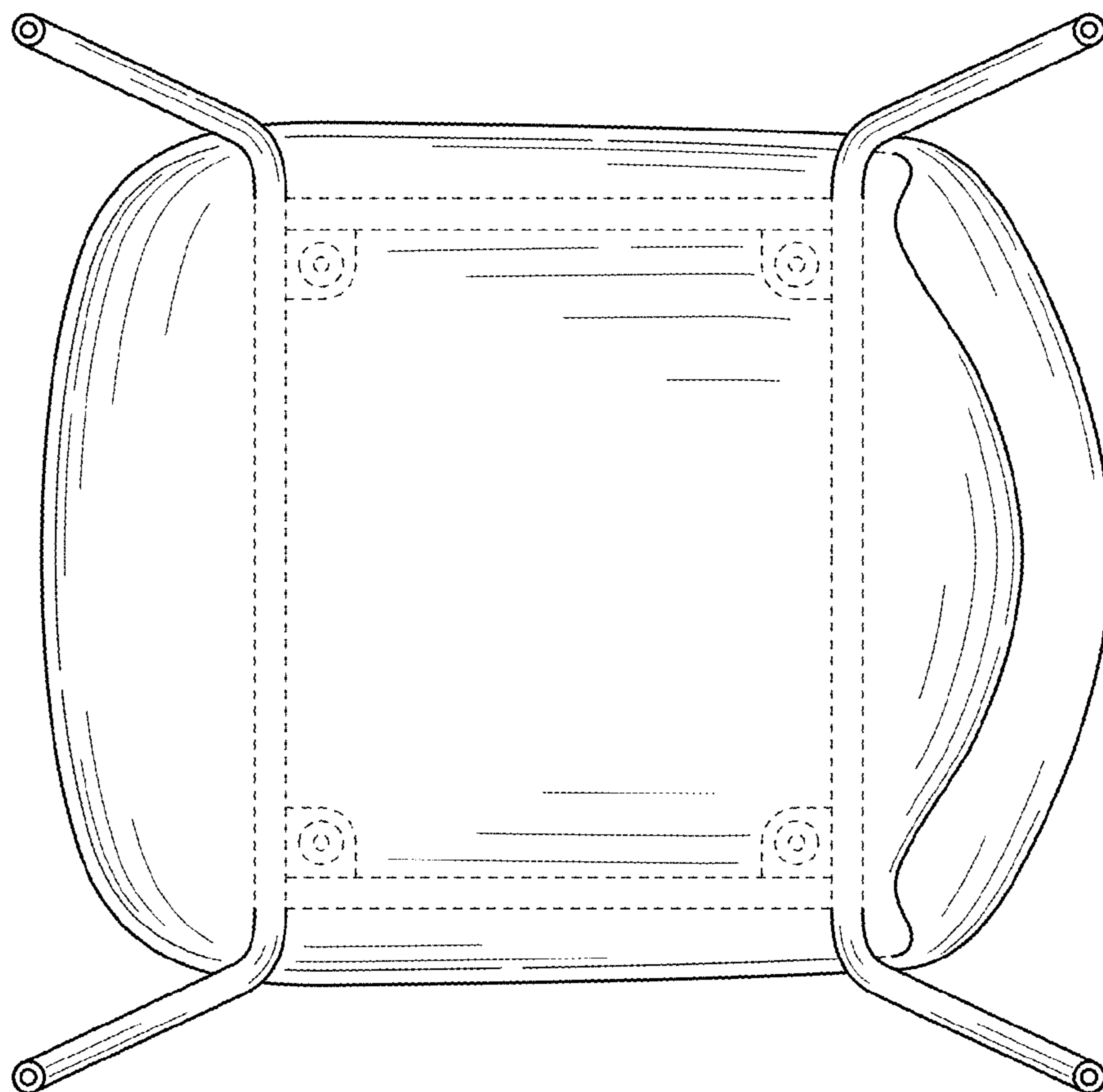

FIG. 7

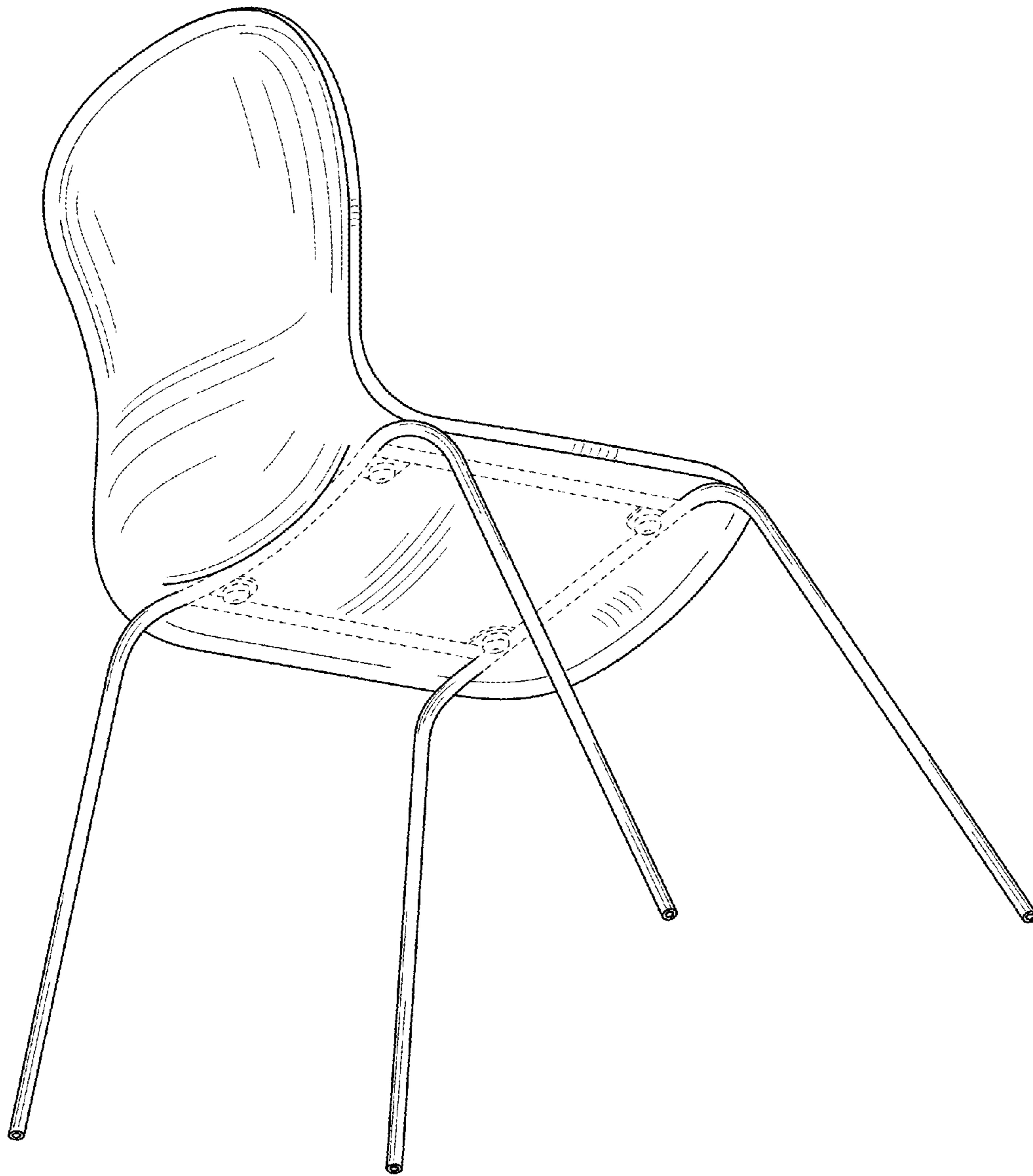

FIG. 8