



US00D715560S

(12) **United States Design Patent**
Li

(10) **Patent No.:** **US D715,560 S**
(45) **Date of Patent:** **** Oct. 21, 2014**

- (54) **HANDLE FOR TOOTHBRUSHES**
- (75) Inventor: **Ming-Kuei Li**, Taipei (TW)
- (73) Assignee: **Shummi Enterprise Co., Ltd.**, Taipei (TW)
- (**) Term: **14 Years**
- (21) Appl. No.: **29/423,368**
- (22) Filed: **May 31, 2012**
- (51) **LOC (10) Cl.** **04-02**
- (52) **U.S. Cl.**
USPC **D4/104; D4/138**
- (58) **Field of Classification Search**
CPC A46B 5/02; A46B 5/021; A46B 5/023;
A46B 5/025; A46B 5/026; A45B 2200/1066
USPC D4/101, 104–112, 132–134, 136, 138;
D7/393, 395, 401.2; D8/107; 16/430,
16/DIG. 12, DIG. 18, DIG. 19; 15/143.1,
15/159.1, 160, 110, 167.1, 167.2;
132/308–311; 601/139, 141, 142
See application file for complete search history.

(56) **References Cited**

U.S. PATENT DOCUMENTS

D459,893 S *	7/2002	Winkler et al.	D4/104
D475,200 S *	6/2003	Crossman et al.	D4/104
D514,322 S *	2/2006	Moskovich	D4/104
D514,814 S *	2/2006	Moskovich et al.	D4/104
D549,459 S *	8/2007	Crossman	D4/104
2002/0124864 A1 *	9/2002	Gross et al.	132/311

OTHER PUBLICATIONS

CN 301182187 Registered Design, (Xu Qiuping) May 5, 2010, [online], [retrieved on Mar. 28, 2014] Retrieved from the Questel Intellectual Property Portal Design Database using the Internet: <URL: http://www.orbit.com>.*

CN 301207106 Registered Design, (Li Zhiming) May 19, 2010, [online], [retrieved on Mar. 28, 2014] Retrieved from the Questel Intellectual Property Portal Design Database using the Internet: <URL: http://www.orbit.com>.*
CN 301533489 Registered Design, (Xu Qiuping) May 4, 2011, [online], [retrieved on Mar. 28, 2014] Retrieved from the Questel Intellectual Property Portal Design Database using the Internet: <URL: http://www.orbit.com>.*

* cited by examiner

Primary Examiner — Melanie H Tung
Assistant Examiner — Lavone D Tabor
(74) *Attorney, Agent, or Firm* — Rosenberg, Klein & Lee

(57) **CLAIM**

The ornamental design for a handle for toothbrushes, as shown and described.

DESCRIPTION

FIG. 1 is a perspective view of a handle for toothbrushes showing the new design;
FIG. 2 is a front view thereof;
FIG. 3 is a rear view thereof;
FIG. 4 is a left side view thereof;
FIG. 5 is a right side view thereof;
FIG. 6 is a top view thereof;
FIG. 7 is a bottom view thereof;
FIG. 8 is an environmental view showing a brush head assembled on the handle; and,
FIG. 9 is an environmental view showing an alternate brush head assembled on the handle.
The broken line showing of a brush head in FIGS. 8 and 9 illustrates environmental structure that forms no part of the claimed design.

1 Claim, 5 Drawing Sheets

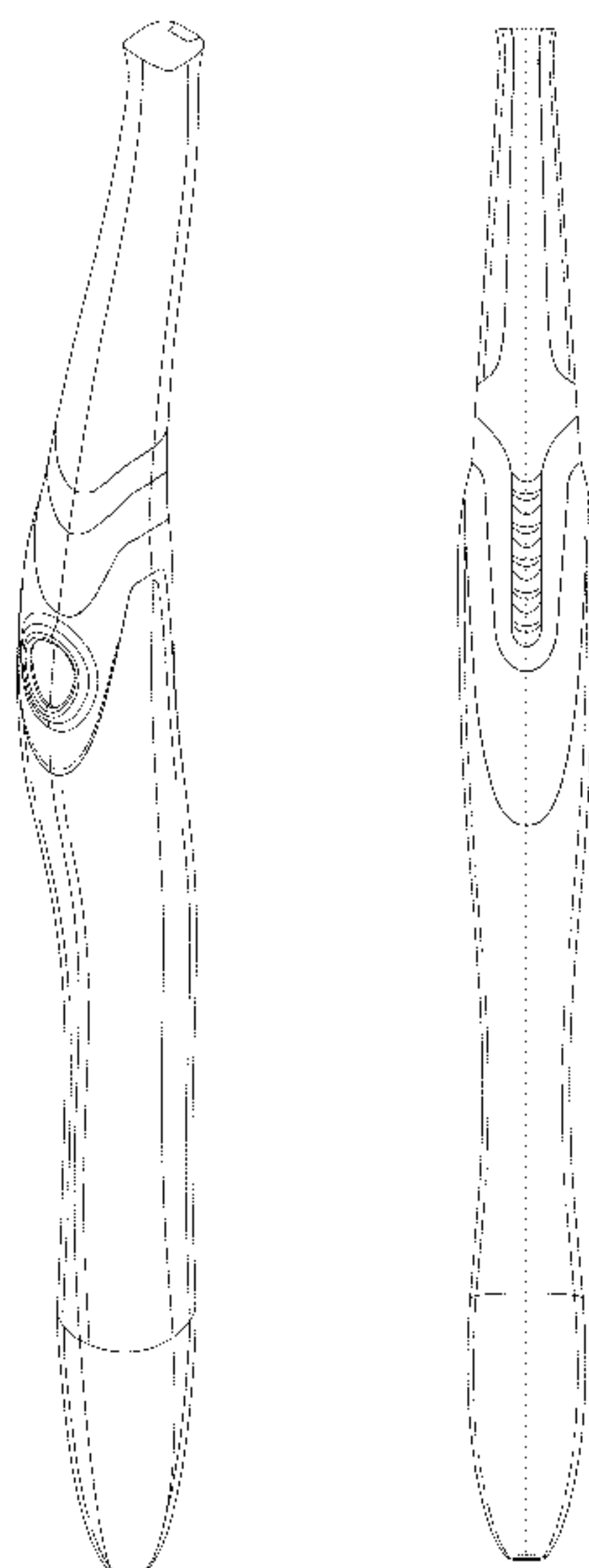

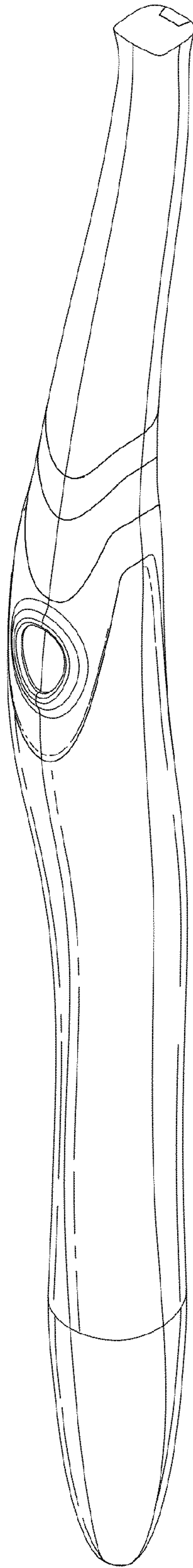

Fig. 1

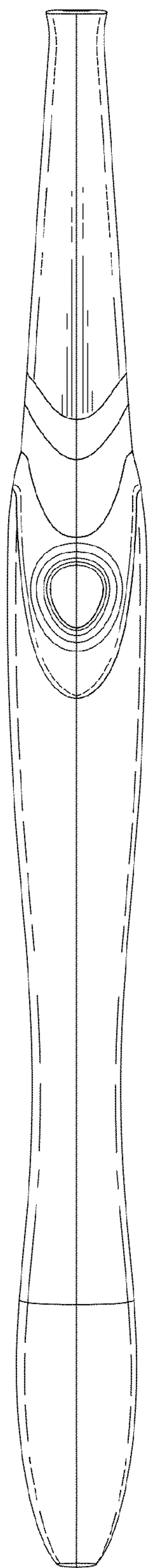

Fig. 2

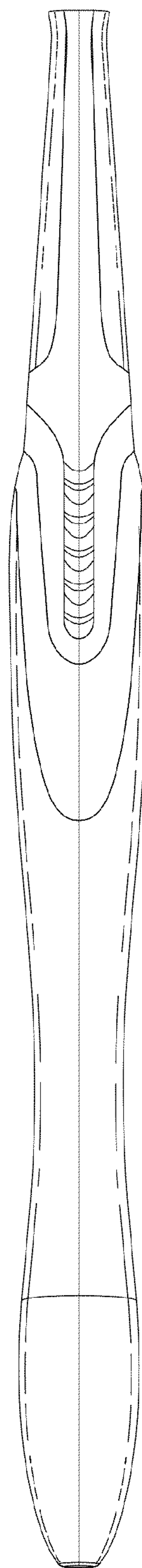

Fig. 3

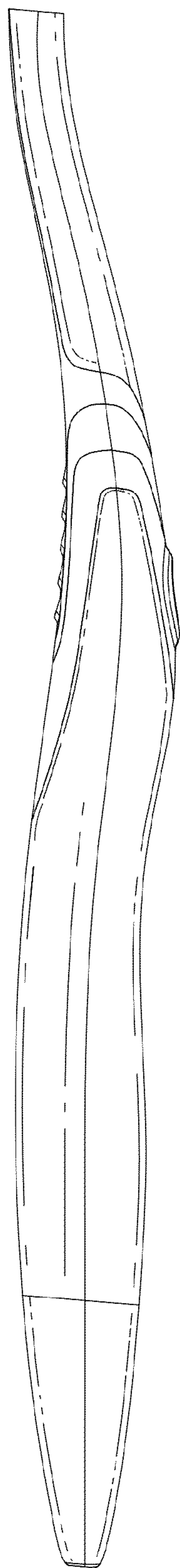

Fig. 4

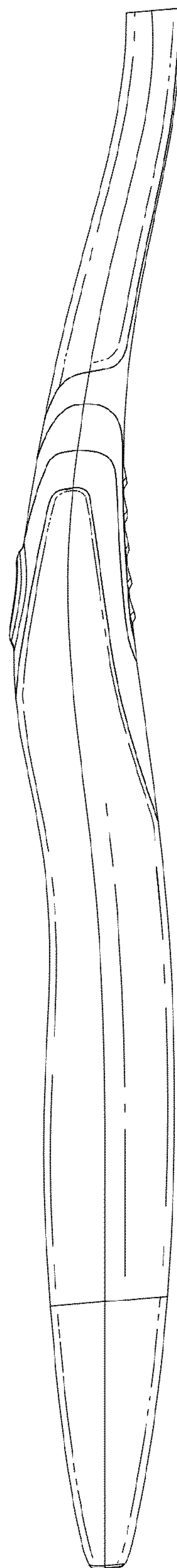

Fig. 5

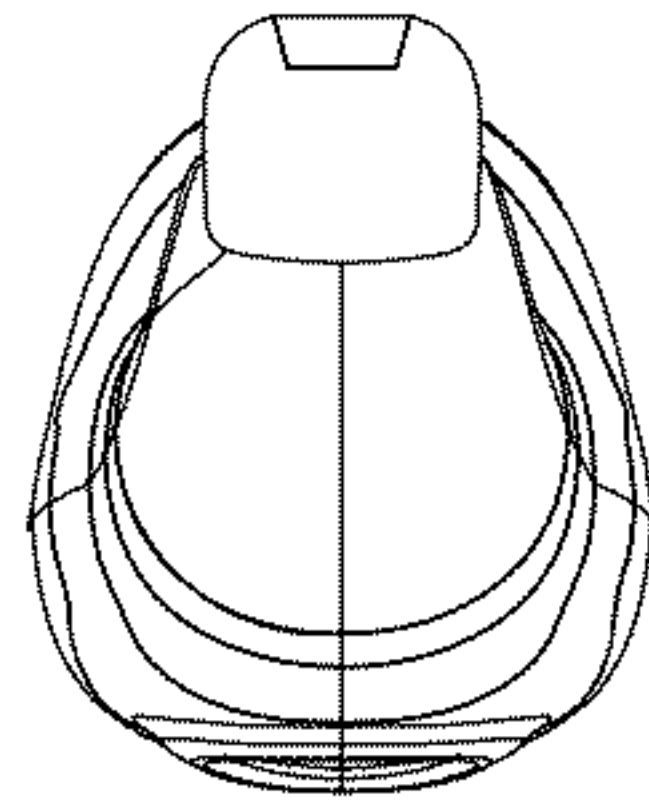

Fig. 6

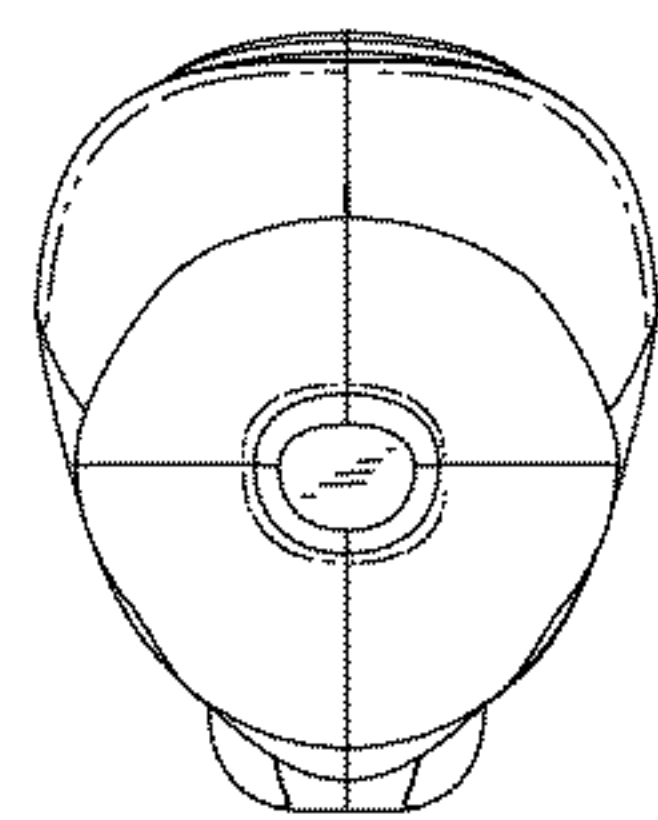

Fig. 7

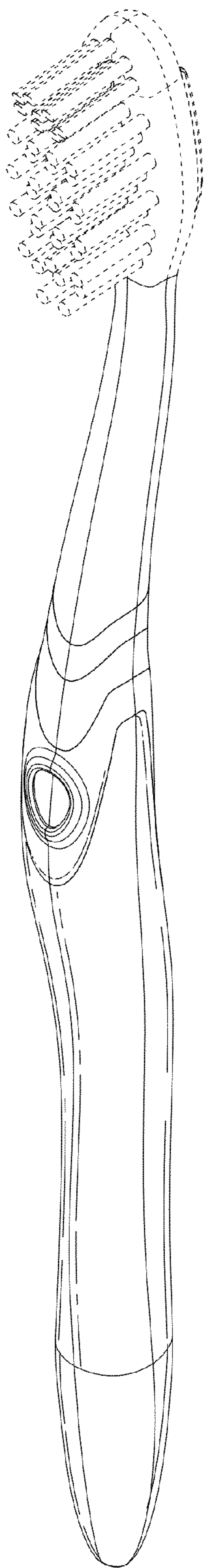

Fig. 8

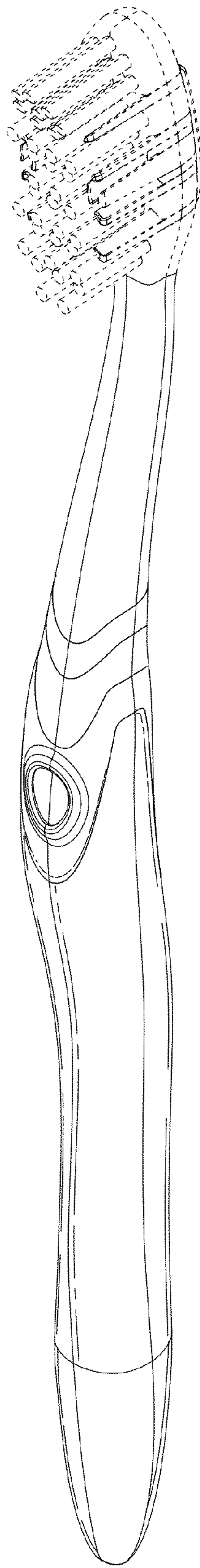

Fig. 9