



US00D715552S

(12) **United States Design Patent**  
**Kuster**

(10) **Patent No.:** **US D715,552 S**

(45) **Date of Patent:** **\*\* Oct. 21, 2014**

(54) **HANDBAG**

D659,391 S \* 5/2012 Jobert ..... D3/243

\* cited by examiner

(71) Applicant: **Laurence Kuster**, London (GB)

*Primary Examiner* — Holly Baynham

(72) Inventor: **Laurence Kuster**, London (GB)

(74) *Attorney, Agent, or Firm* — Fross Zelnick Lehrman & Zissu, P.C.; Lawrence E. Apolzon, Esq.

(73) Assignee: **J. Choo Limited**, London (GB)

(57) **CLAIM**

The ornamental design for a handbag, as shown and described.

(\*\*) Term: **14 Years**

**DESCRIPTION**

(21) Appl. No.: **29/459,465**

FIG. 1 is a front perspective view of an alternative embodiment of the handbag shown in FIG. 1;

(22) Filed: **Jun. 28, 2013**

FIG. 2 is a front view of the handbag shown in FIG. 1;

(30) **Foreign Application Priority Data**

Mar. 14, 2013 (EM) ..... 002202747-0032

FIG. 3 is a rear view of the handbag shown in FIG. 1;

(51) **LOC (10) Cl.** ..... **03-01**

FIG. 4 is a left side view of the handbag shown in FIG. 1;

(52) **U.S. Cl.**  
USPC ..... **D3/318**

FIG. 5 is a right side view of the handbag shown in FIG. 1;

(58) **Field of Classification Search**  
USPC ..... D3/232–233, 240–243, 245–246;  
150/100, 103–110, 113–114, 117–119  
See application file for complete search history.

FIG. 6 is a top view of the handbag shown in FIG. 1;

FIG. 7 is a bottom view of the handbag shown in FIG. 1;

FIG. 8 is a front perspective view of another alternative embodiment of the handbag shown in FIG. 1;

FIG. 9 is a front view of the handbag shown in FIG. 8;

FIG. 10 is a rear view of the handbag shown in FIG. 8;

FIG. 11 is a left side view of the handbag shown in FIG. 8;

FIG. 12 is a right side view of the handbag shown in FIG. 8;

FIG. 13 is a top view of the handbag shown in FIG. 8; and,

FIG. 14 is a bottom view of the handbag shown in FIG. 8.

(56) **References Cited**

**U.S. PATENT DOCUMENTS**

D519,732 S \* 5/2006 Gonzalez ..... D3/243  
D549,963 S 9/2007 Gonzalez  
D570,106 S \* 6/2008 Della Valle ..... D3/243  
D582,668 S 12/2008 Gonzalez  
D649,779 S \* 12/2011 Fendi ..... D3/243  
D652,619 S \* 1/2012 Smith et al. .... D3/243

The broken line showing of portions of the body of the handbag, chain handles, handle rings, front chain and front plaque in relevant drawings shows unclaimed subject matter for the design in those drawings.

The break lines shown in the drawings of the chain handle indicate indeterminate length.

**1 Claim, 10 Drawing Sheets**

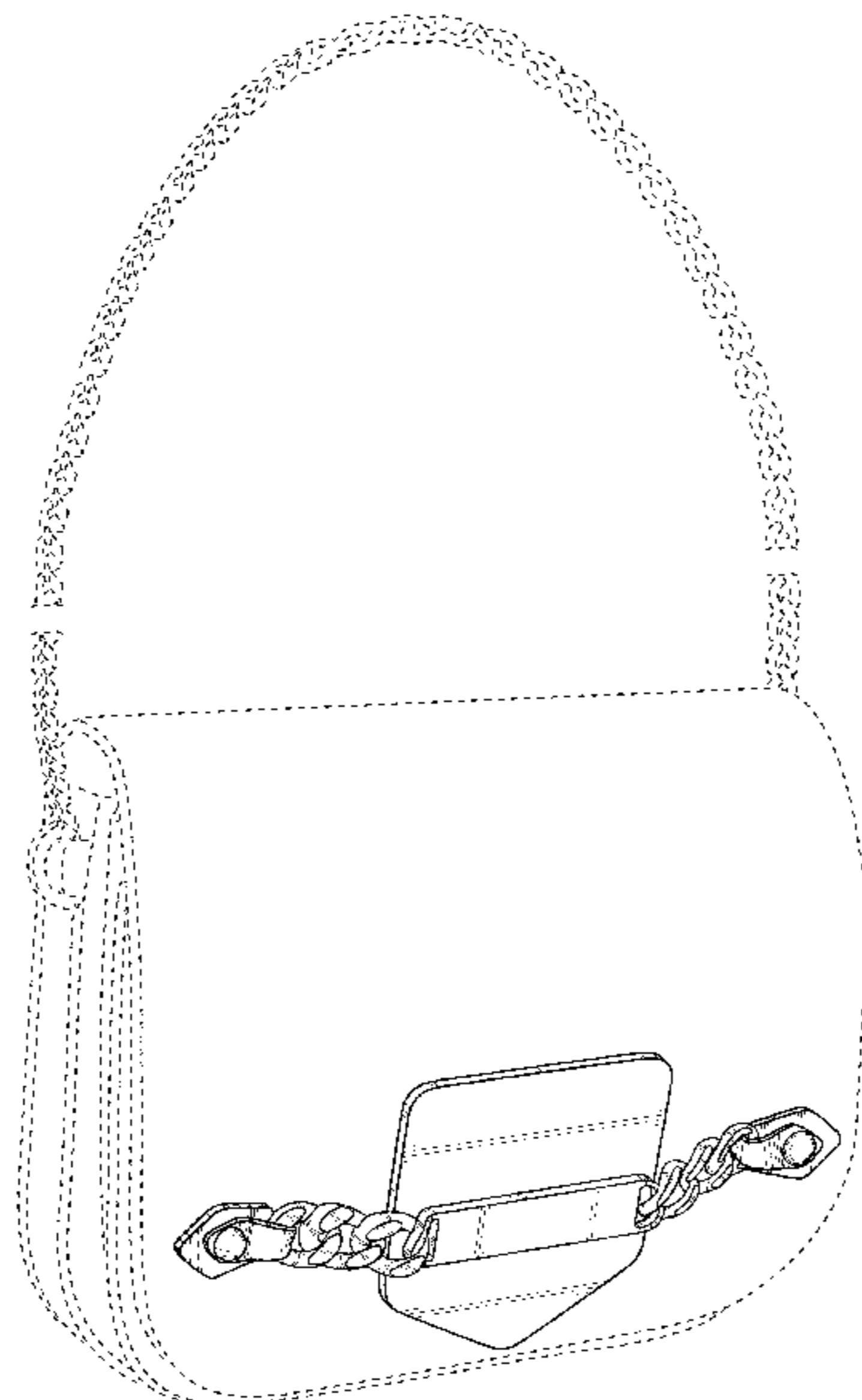

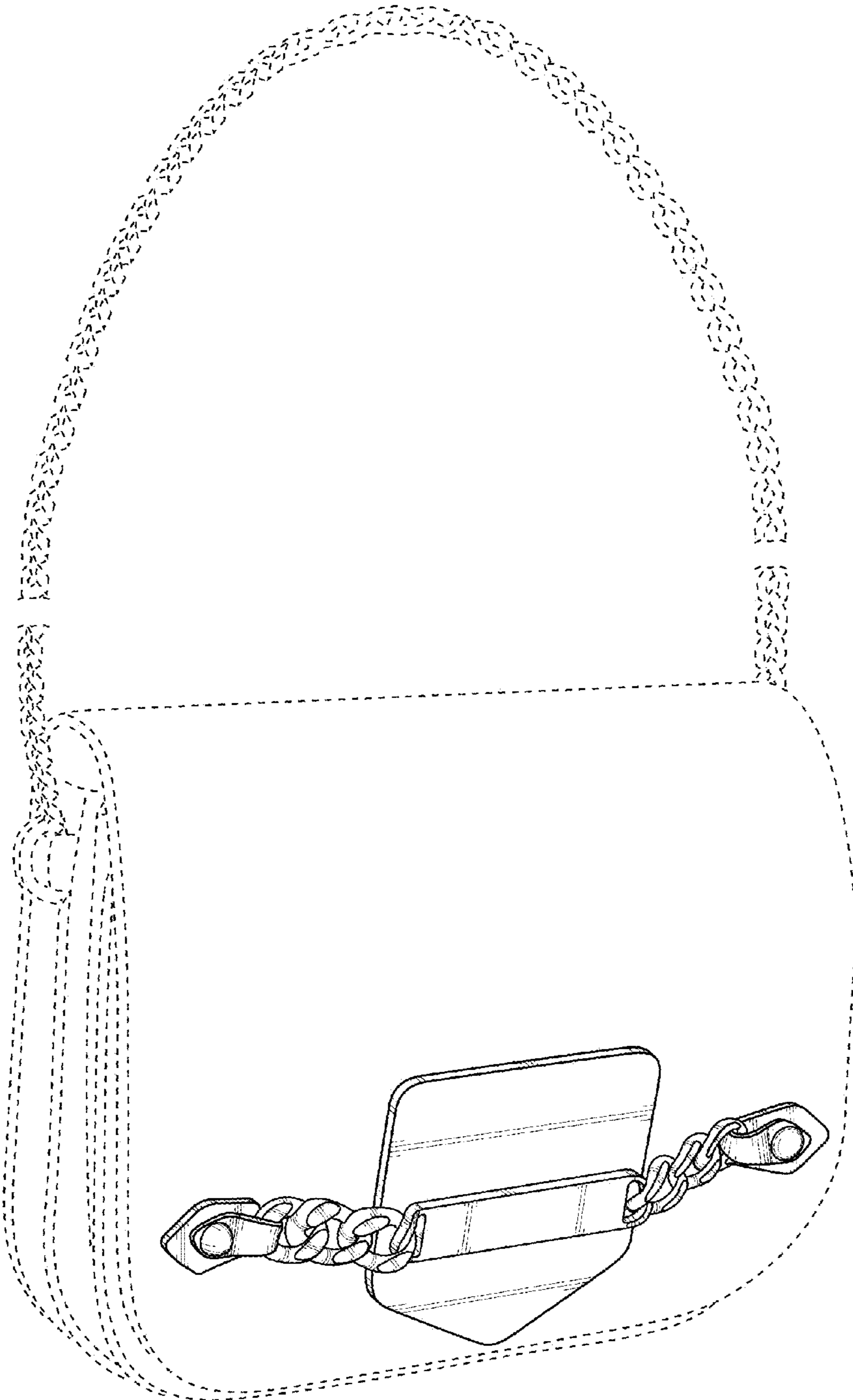

FIG. 1

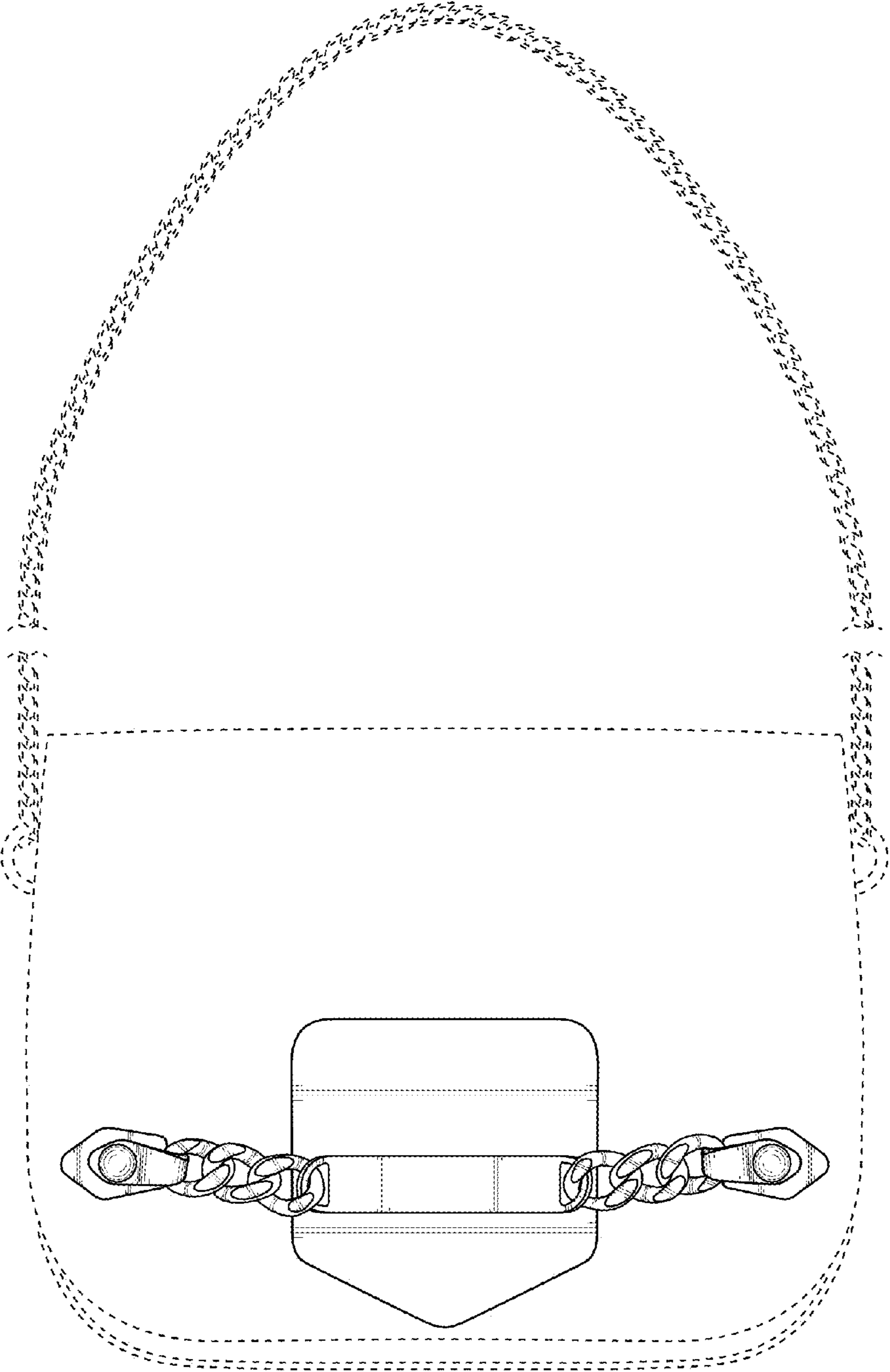

FIG. 2

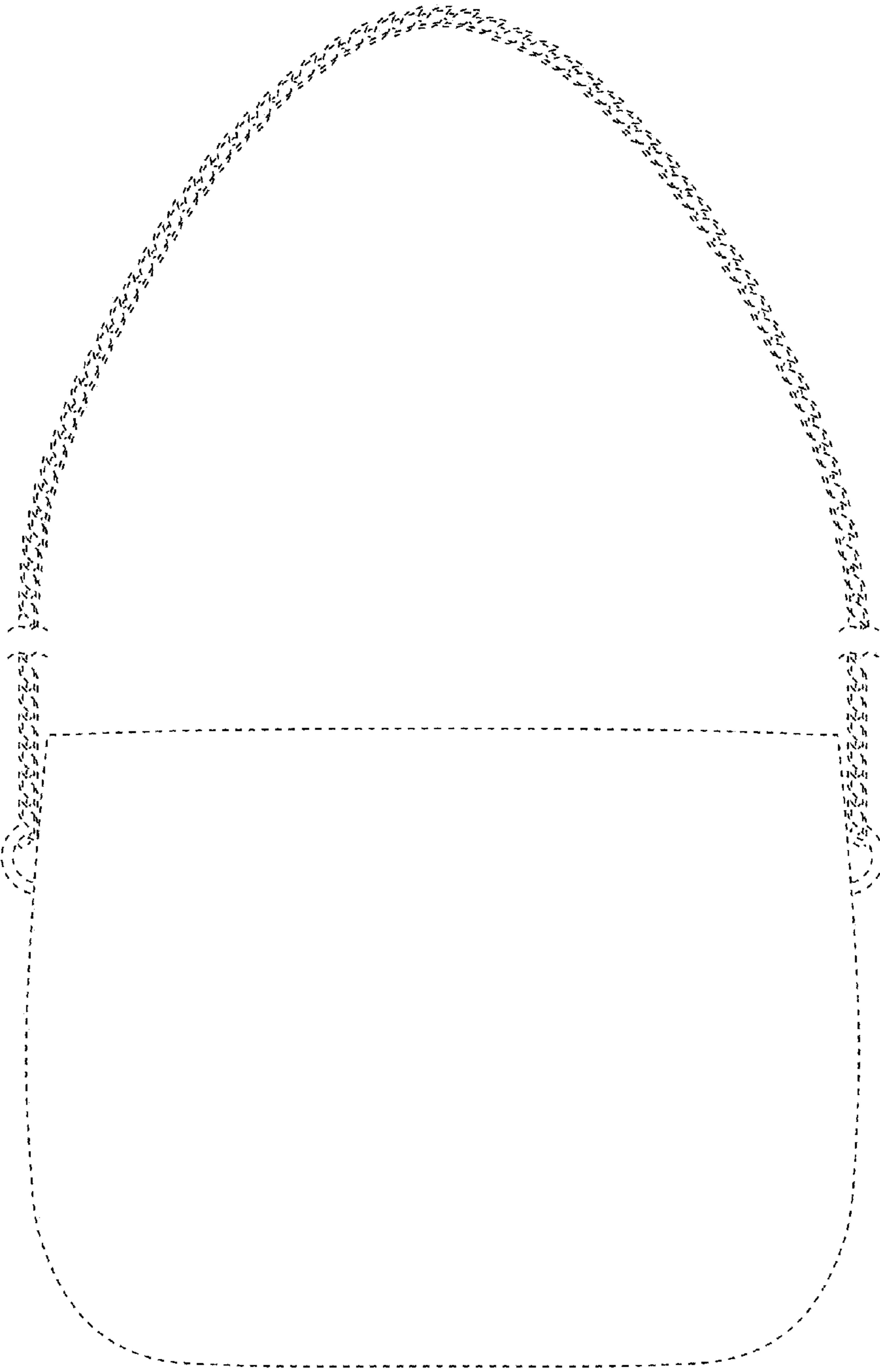

FIG. 3

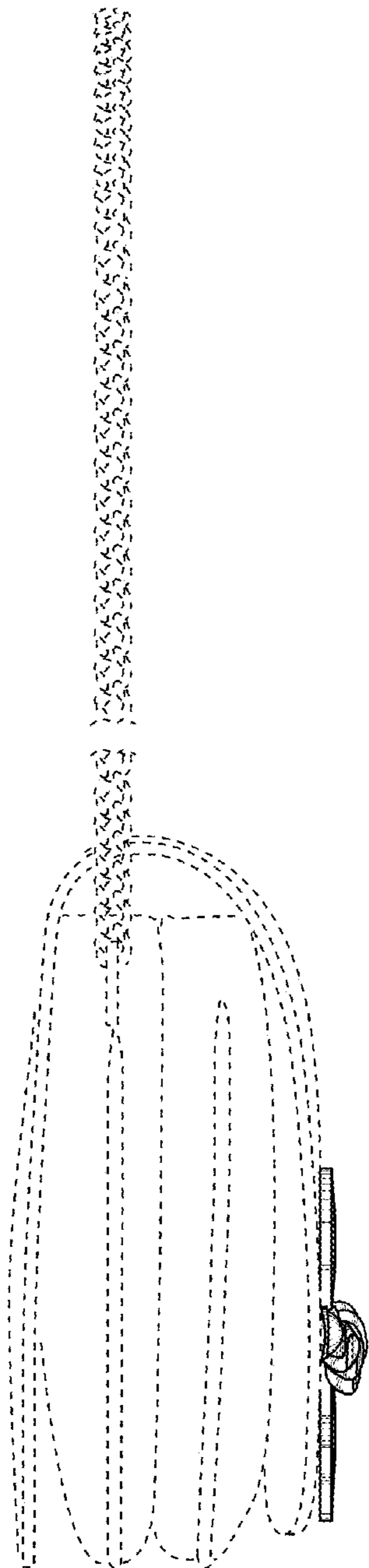

FIG. 4

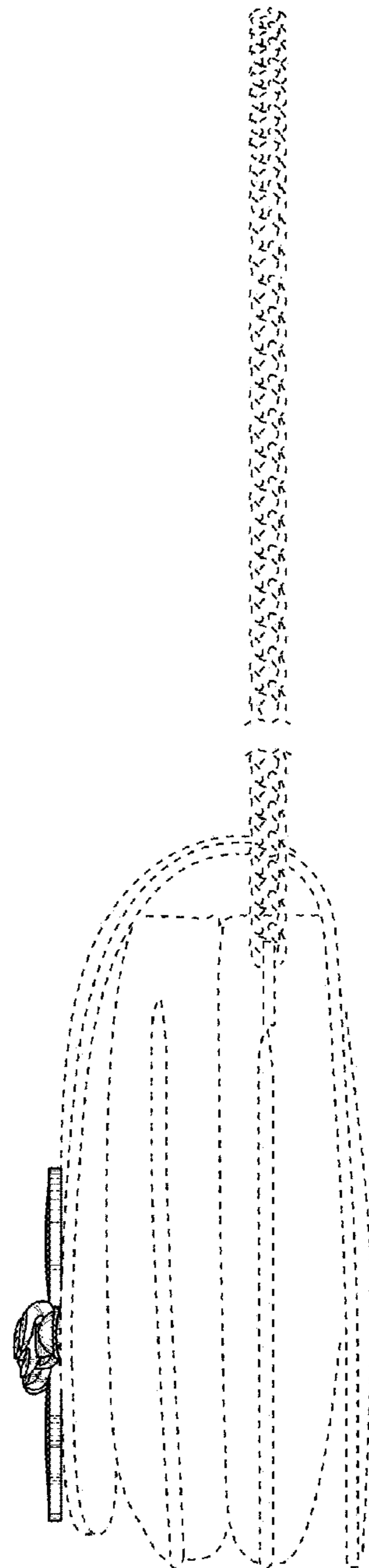

FIG. 5

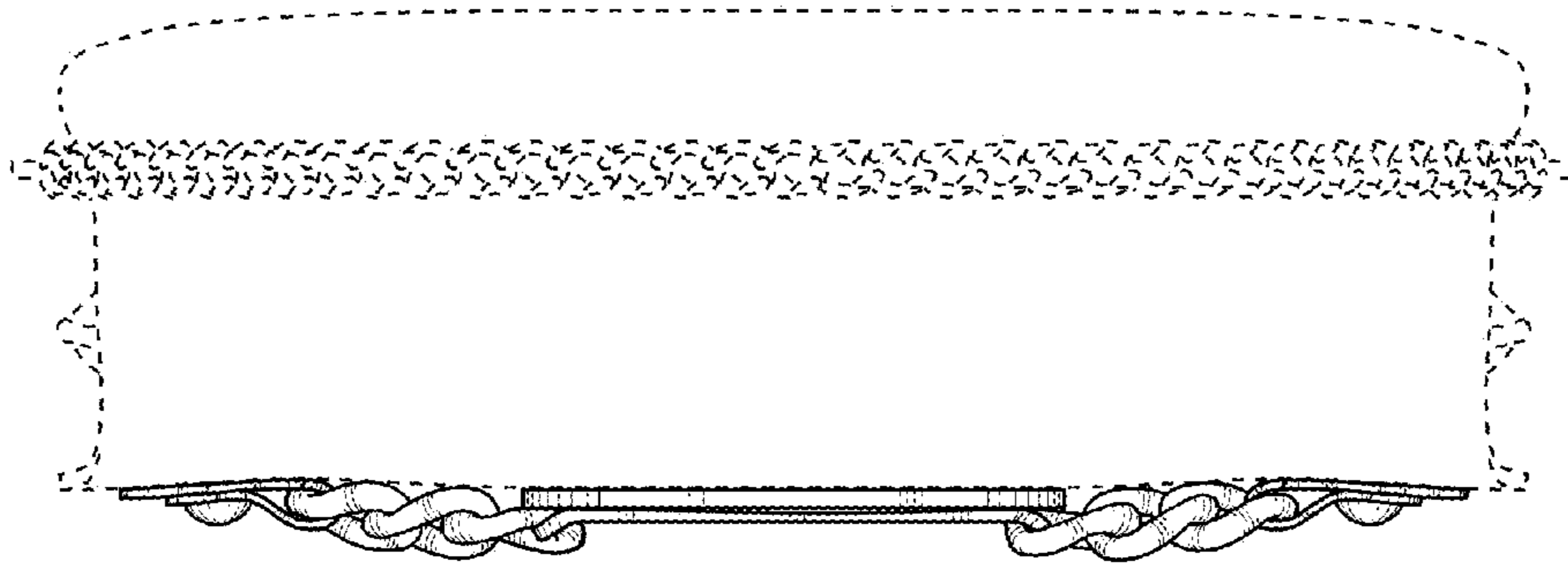

FIG. 6

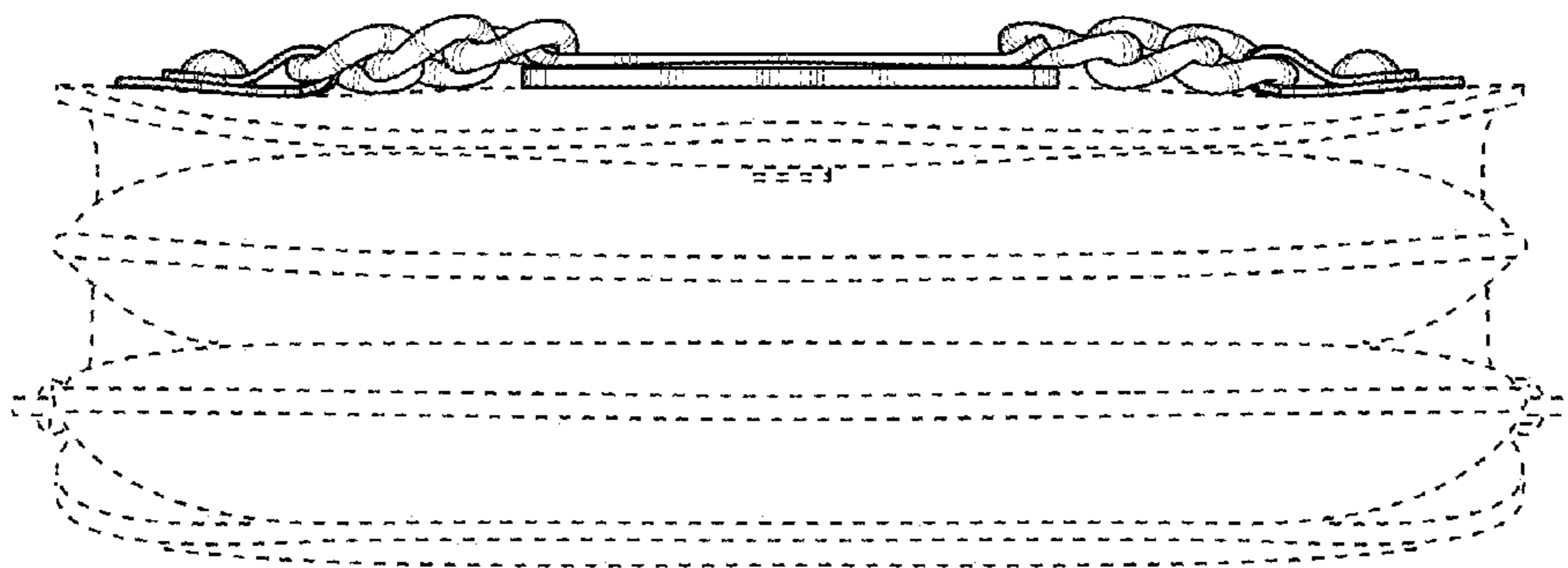

FIG. 7

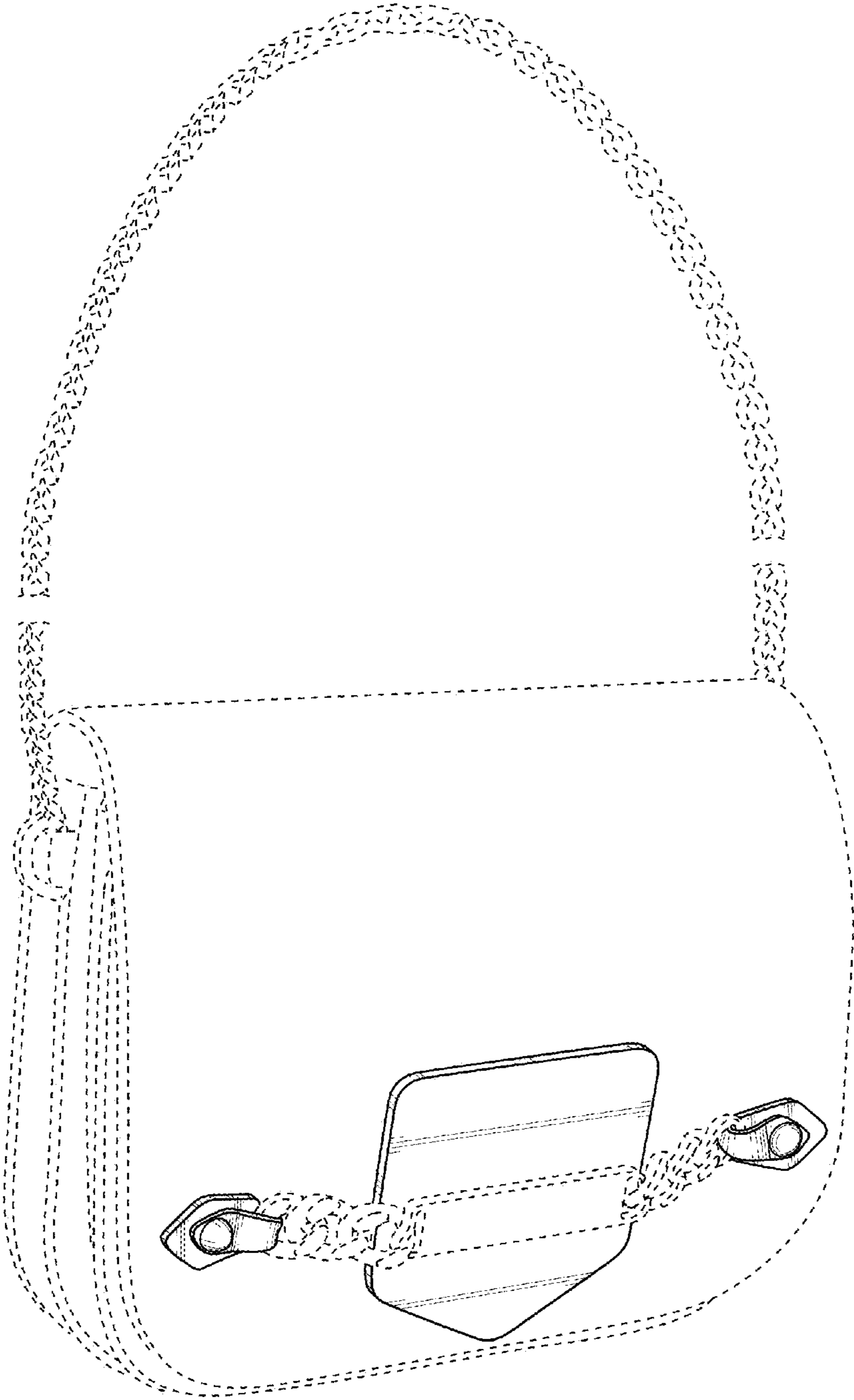

FIG. 8

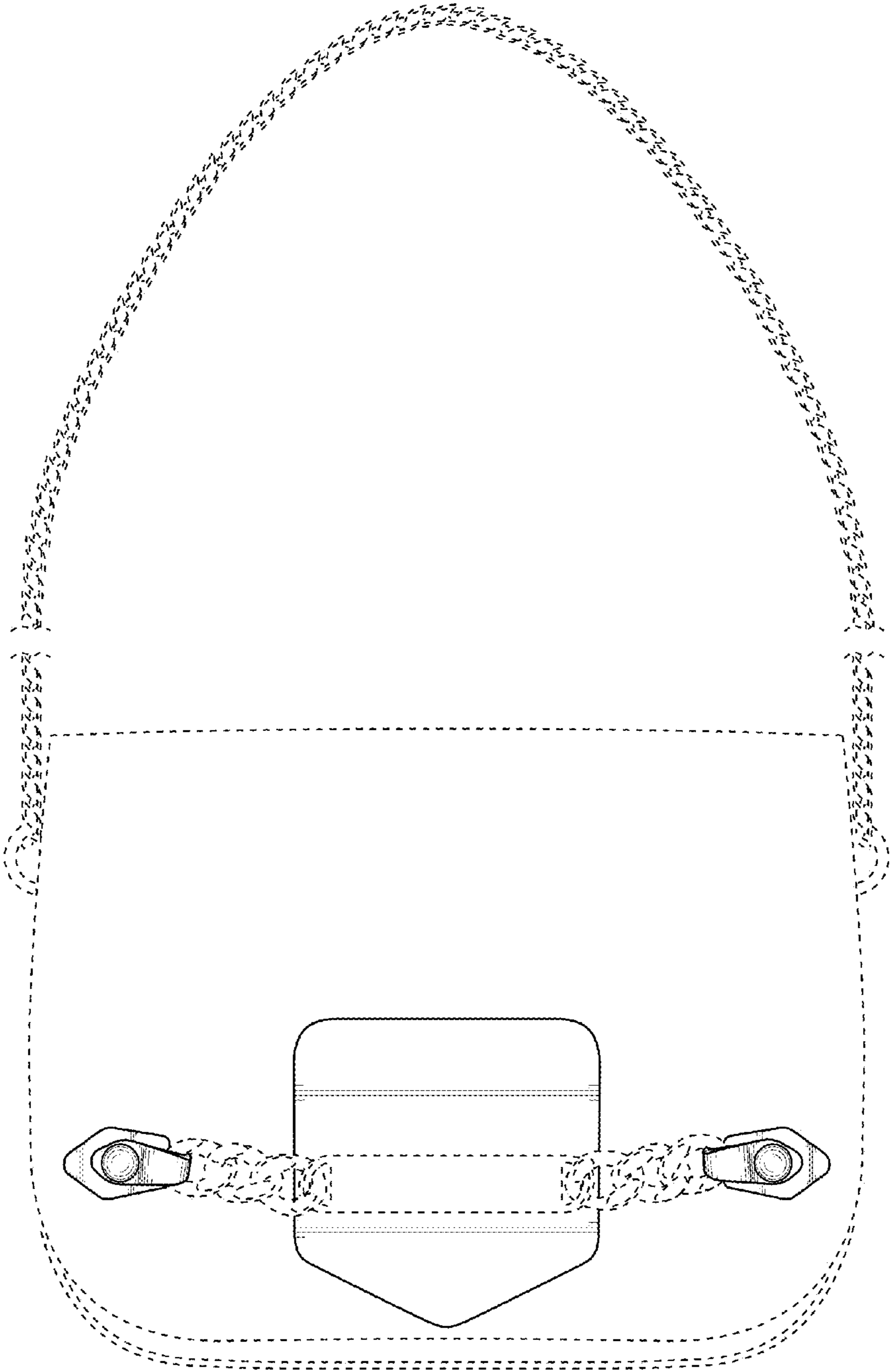

FIG. 9



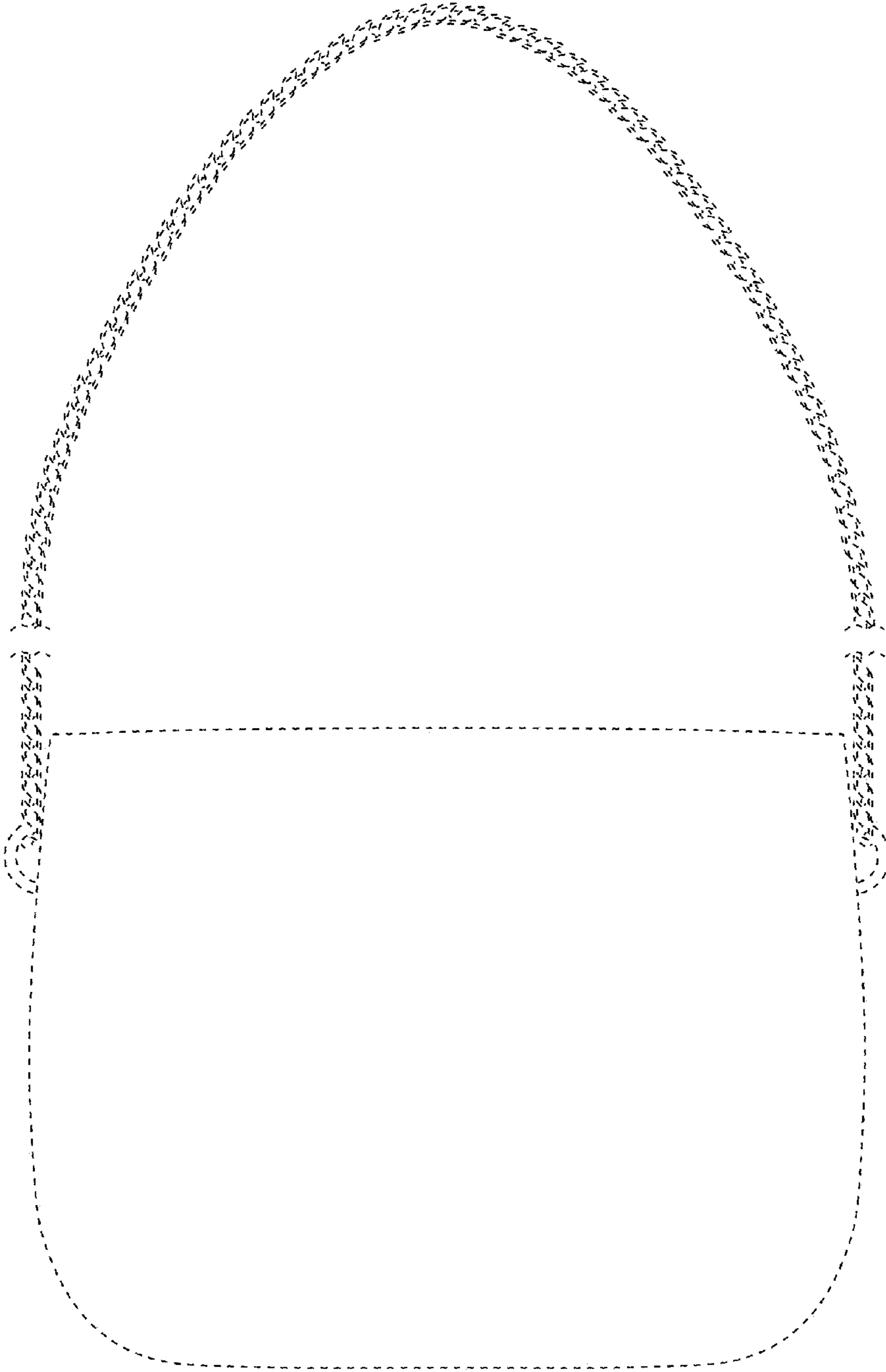

FIG. 10

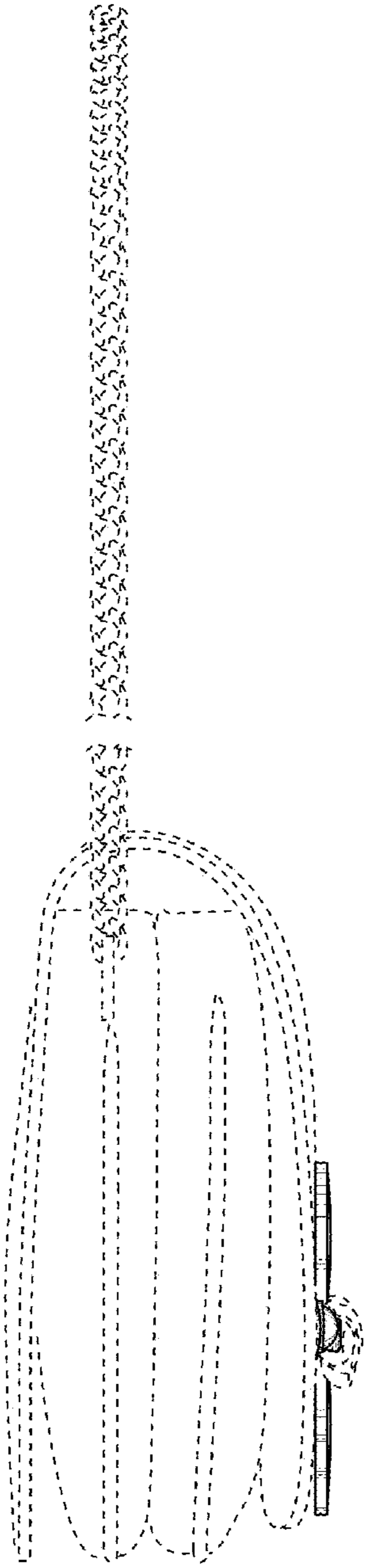

FIG. 11

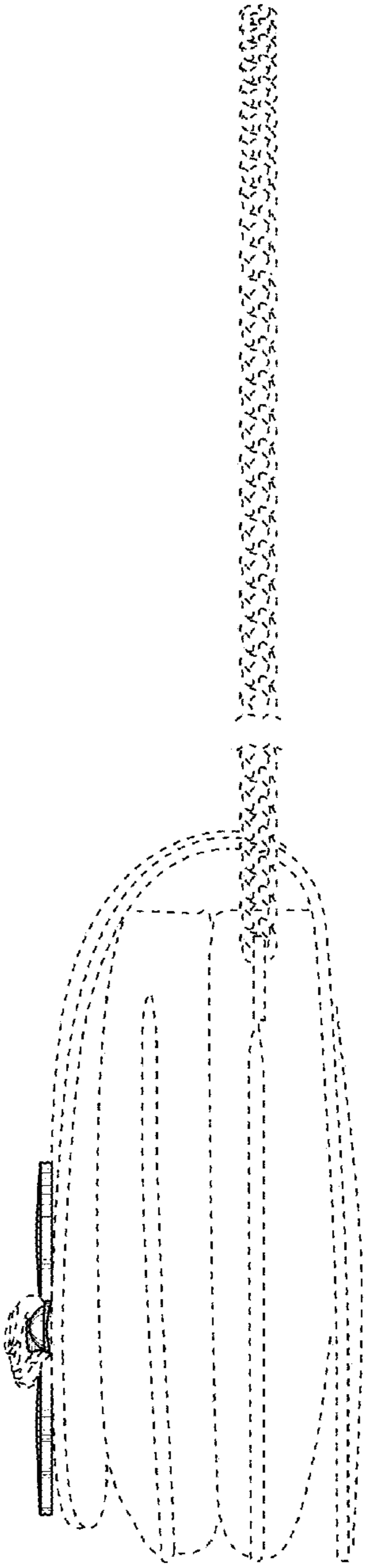

FIG. 12

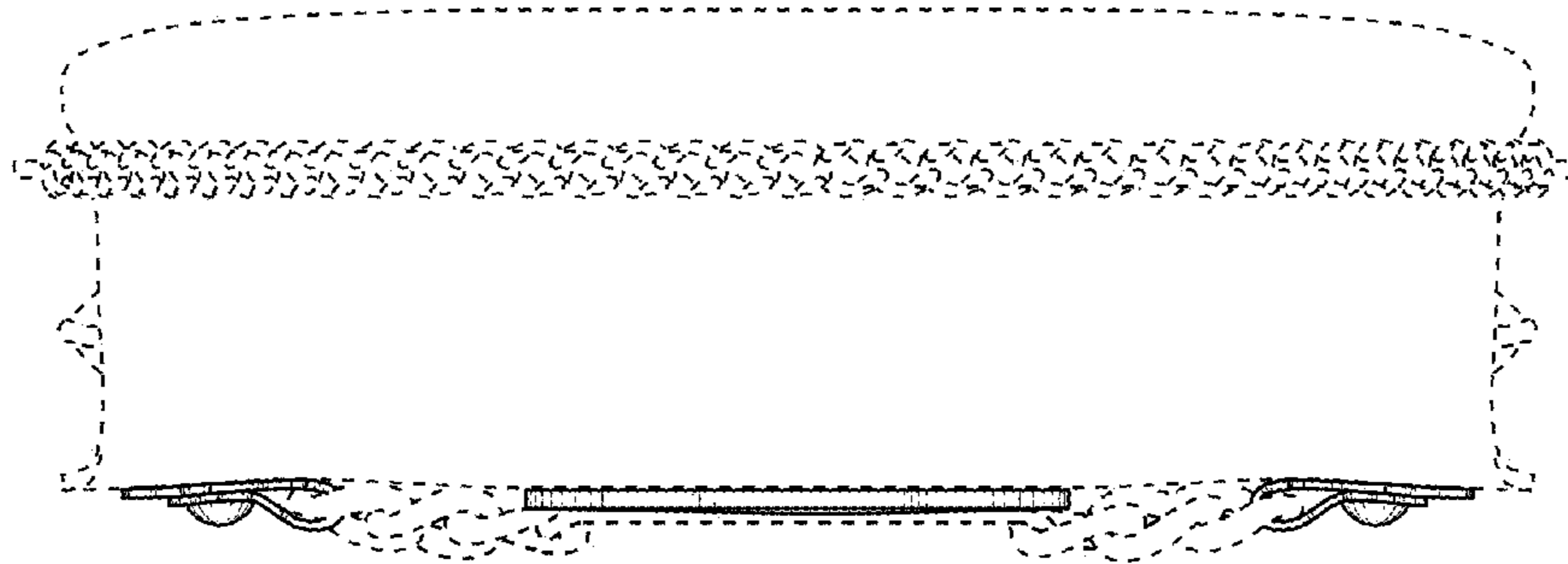

FIG. 13

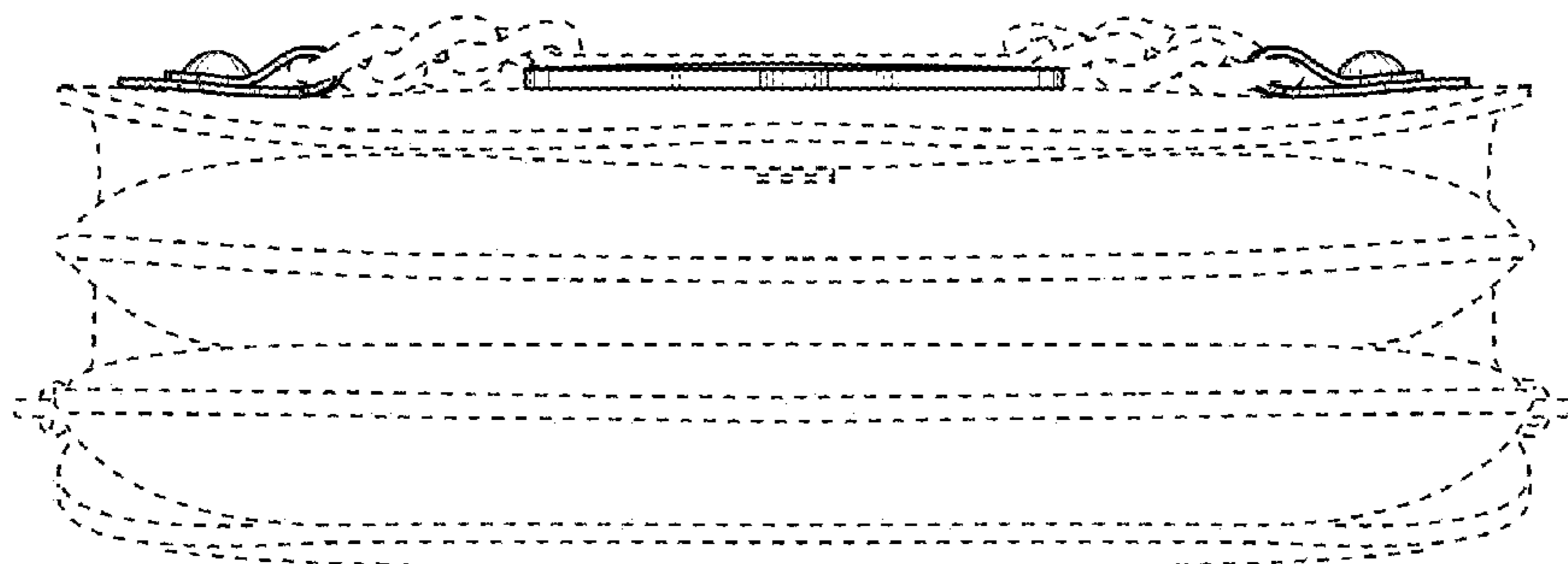

FIG. 14