



US00D715491S

(12) **United States Design Patent**
Phillips et al.

(10) **Patent No.:** **US D715,491 S**
(45) **Date of Patent:** **** Oct. 14, 2014**

- (54) **BASE WITH PROJECTIONS**
- (71) Applicants: **Ben Phillips**, Sterling, IL (US); **Gary Snow**, Rock Falls, IL (US); **Chad Aulwes**, Sterling, IL (US)
- (72) Inventors: **Ben Phillips**, Sterling, IL (US); **Gary Snow**, Rock Falls, IL (US); **Chad Aulwes**, Sterling, IL (US)
- (73) Assignee: **Wahl Clipper Corporation**, Sterling, IL (US)
- (**) Term: **14 Years**
- (21) Appl. No.: **29/480,621**
- (22) Filed: **Jan. 28, 2014**

Related U.S. Application Data

- (62) Division of application No. 29/449,886, filed on Mar. 15, 2013, now Pat. No. Des. 701,647.
- (51) **LOC (10) Cl.** **28-03**
- (52) **U.S. Cl.**
USPC **D28/54**
- (58) **Field of Classification Search**
USPC D28/44-48, 49-54; 30/34.05, 32, 34.1, 30/34.2, 43-43.92, 526-527, 44-45, 341, 30/272.1, 226-227, 231, 233-233.5, 537
See application file for complete search history.

(56) **References Cited**

U.S. PATENT DOCUMENTS

5,068,966	A	12/1991	Wahl et al.
D340,783	S	10/1993	McCambridge
D373,853	S	9/1996	Melton et al.
D435,936	S	1/2001	Long et al.
D436,692	S	1/2001	Larsen
D443,725	S	6/2001	Copland et al.
D458,710	S	6/2002	Altamore et al.
D472,674	S	4/2003	Long et al.

D479,362	S	9/2003	Dirks
D497,452	S	10/2004	Nielsen et al.
D500,391	S	12/2004	Nielsen et al.
D501,278	S	1/2005	Nielsen et al.
D513,344	S	12/2005	Choi
6,986,206	B2	1/2006	McCambridge et al.
7,057,374	B2	6/2006	Freas et al.
D555,286	S	11/2007	Long
7,346,990	B2	3/2008	Dirks et al.

(Continued)

OTHER PUBLICATIONS

U.S. Appl. No. 29/449,853, filed Mar. 15, 2013.

(Continued)

Primary Examiner — Jennifer Rivard

(74) *Attorney, Agent, or Firm* — Greer Burns & Crain Ltd.

(57) **CLAIM**

The ornamental design for the base with projections, as shown and described.

DESCRIPTION

FIG. 1 is a perspective view of an embodiment of the base with projections showing our new design.

FIG. 2 is a front end view of the base with projections shown in FIG. 1;

FIG. 3 is a back end view of the base with projections shown in FIG. 1;

FIG. 4 is a left side view of the base with projections shown in FIG. 1;

FIG. 5 is a right side view of the base with projections shown in FIG. 1;

FIG. 6 is a top view of the base with projections shown in FIG. 1; and,

FIG. 7 is a bottom view of the base with projections shown in FIG. 1.

The broken lines illustrate environmental structure and form no part of the claimed design.

1 Claim, 4 Drawing Sheets

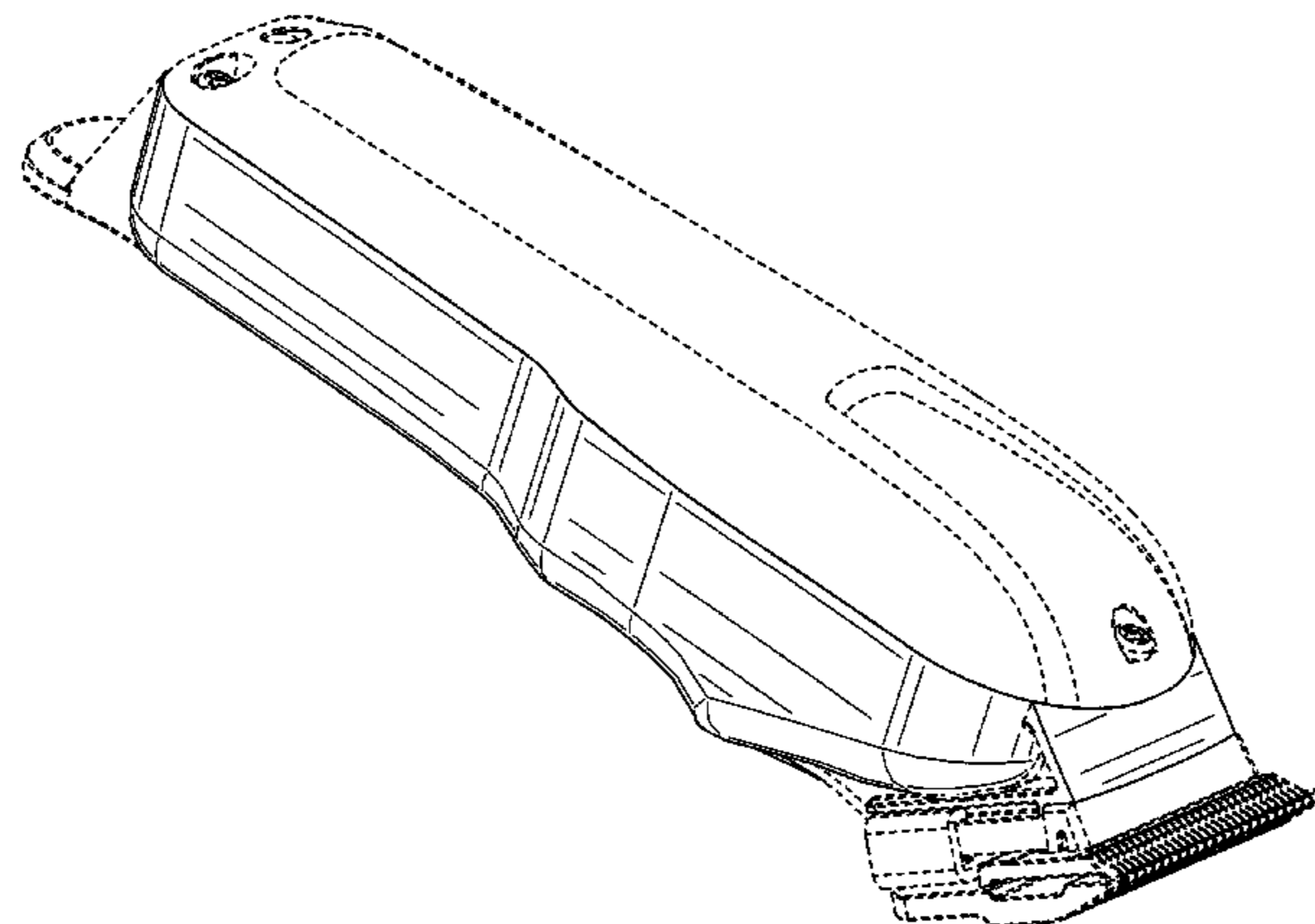

(56)

References Cited

U.S. PATENT DOCUMENTS

D573,756 S 7/2008 Nielsen et al.
D577,865 S 9/2008 Long et al.
D582,604 S 12/2008 Eddinger et al.
D597,254 S 7/2009 Eddinger et al.
D619,303 S * 7/2010 Aulwes et al. D28/53
D621,546 S 8/2010 Aulwes et al.
D628,304 S 11/2010 Aulwes et al.
D652,170 S 1/2012 Snow et al.
D675,780 S 2/2013 Wallace et al.

D675,781 S 2/2013 Whittaker et al.
D675,782 S 2/2013 Buck, Jr.
D678,612 S * 3/2013 Aulwes et al. D28/53
D701,647 S * 3/2014 Snow et al. D28/54

OTHER PUBLICATIONS

U.S. Appl. No. 29/479,758, filed Jan. 20, 2014.
U.S. Appl. No. 29/449,815, filed Mar. 15, 2013.
U.S. Appl. No. 29/479,762, filed Jan. 20, 2014.

* cited by examiner

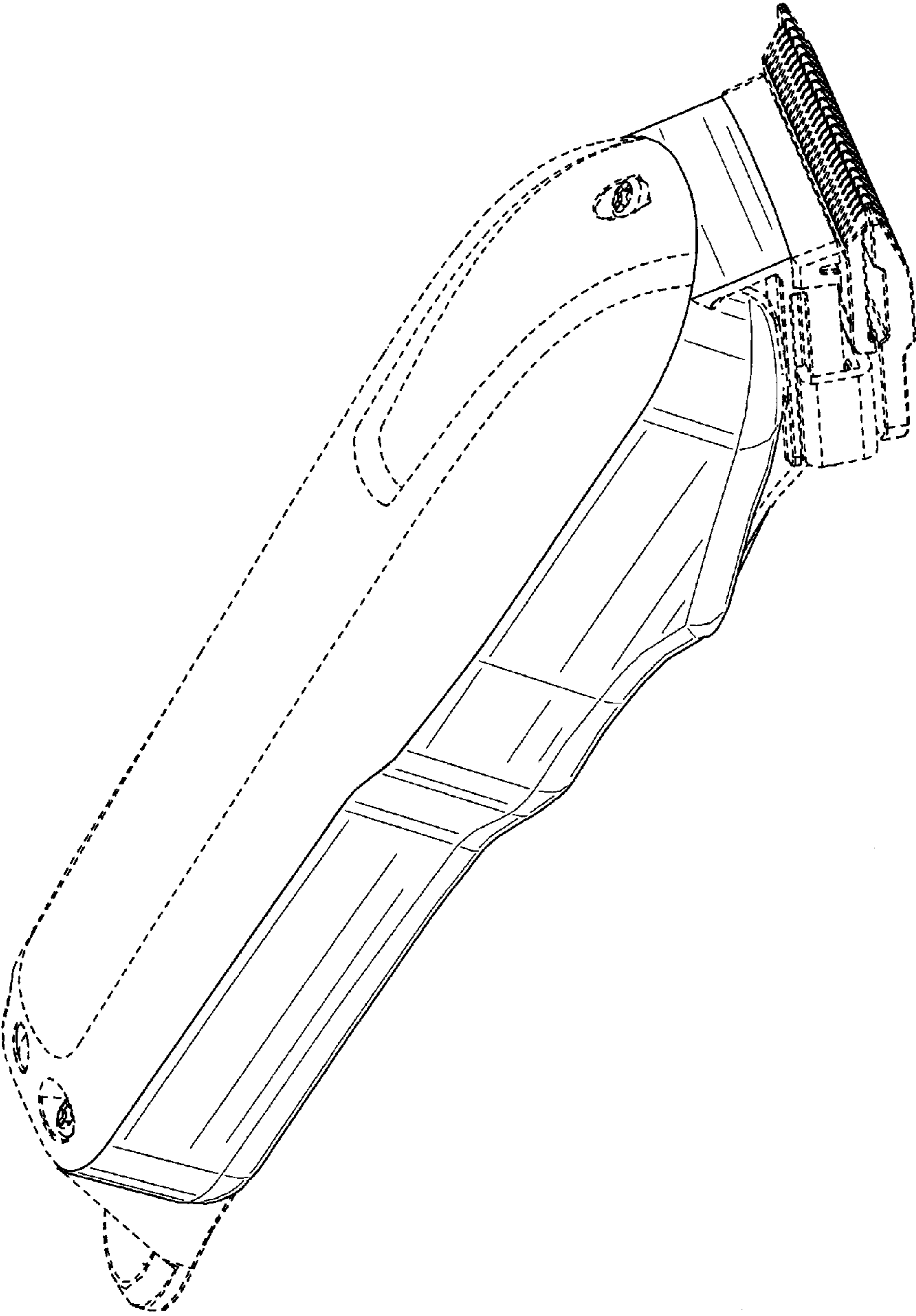

FIG. 1

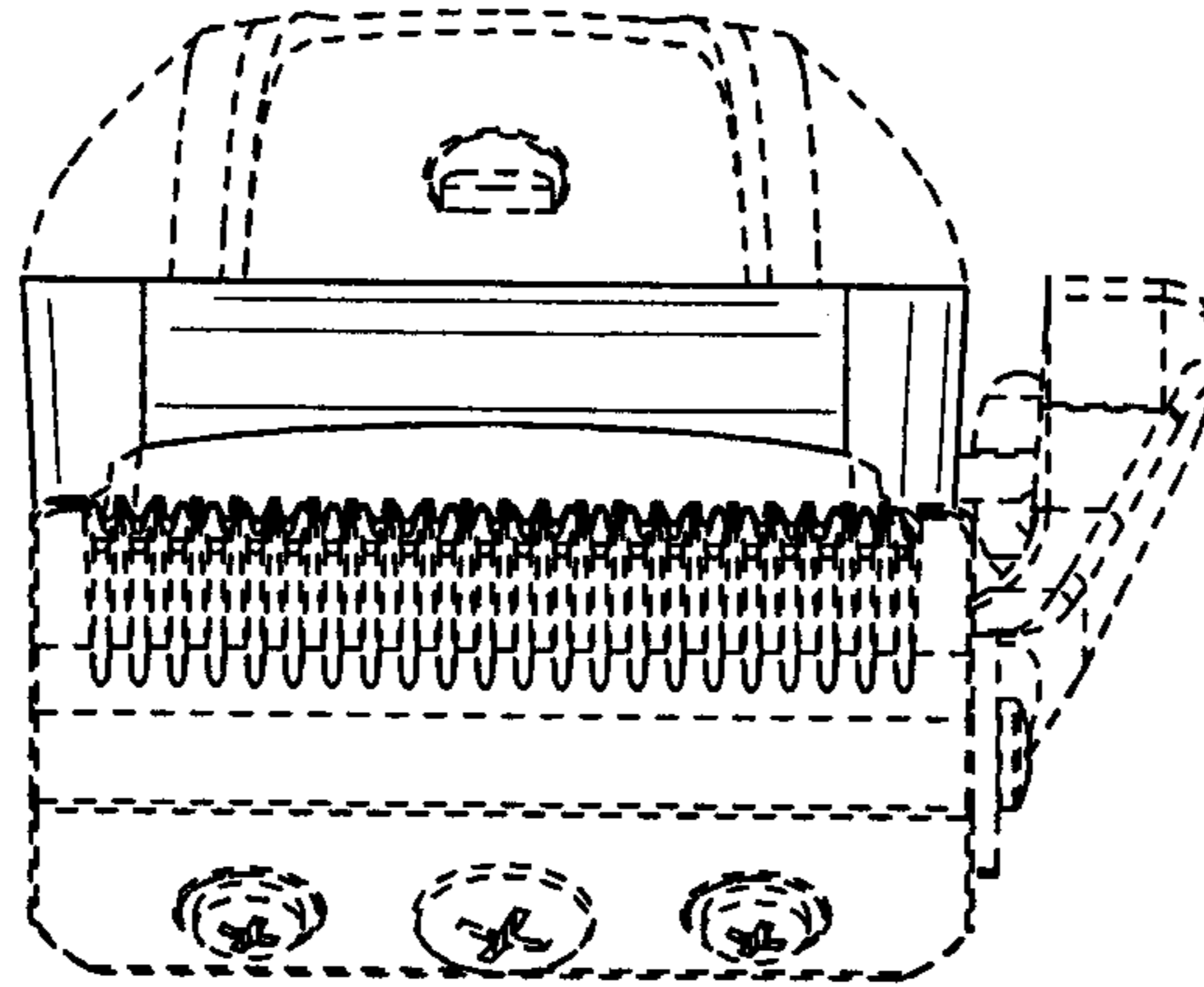

FIG. 2

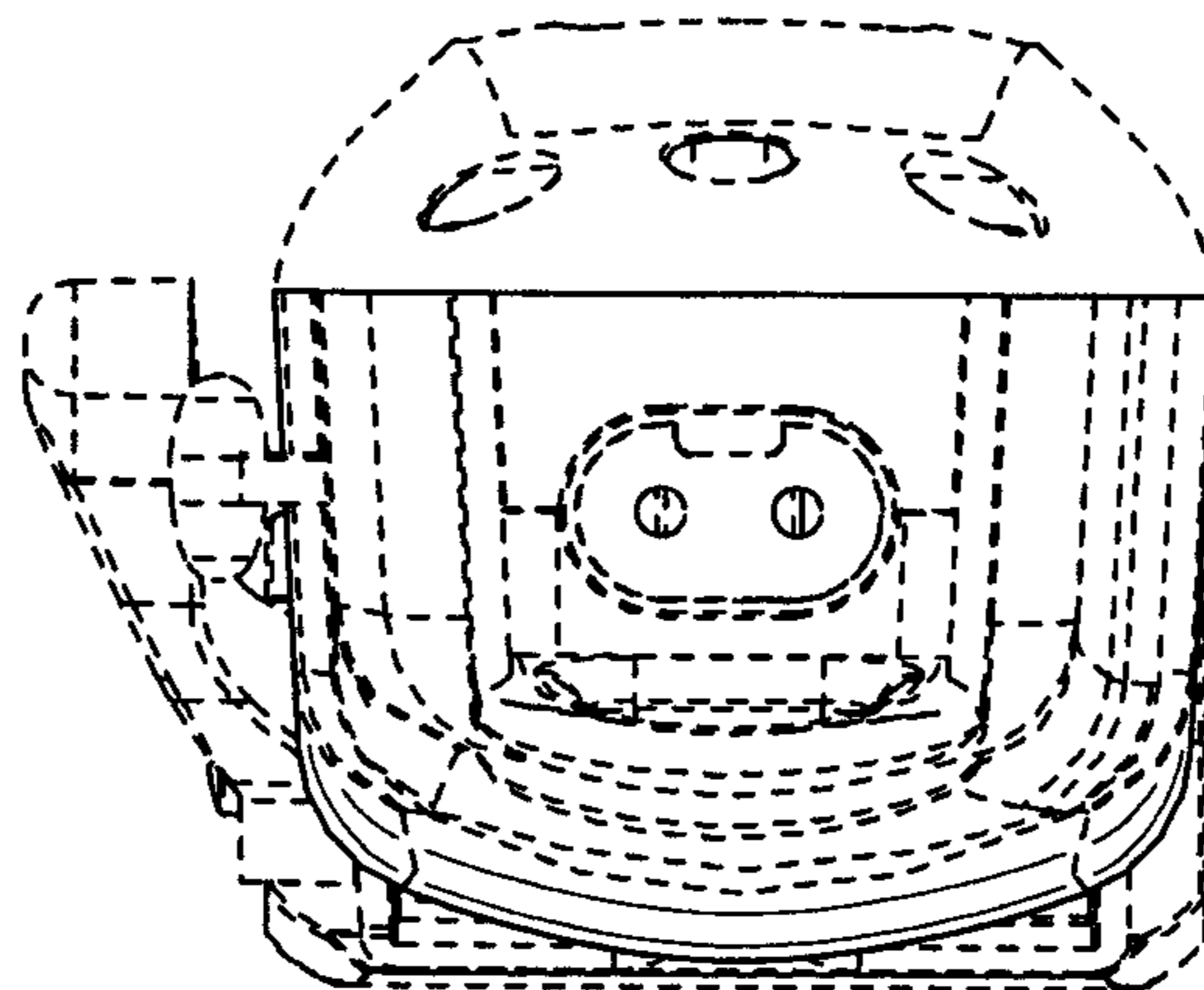

FIG. 3

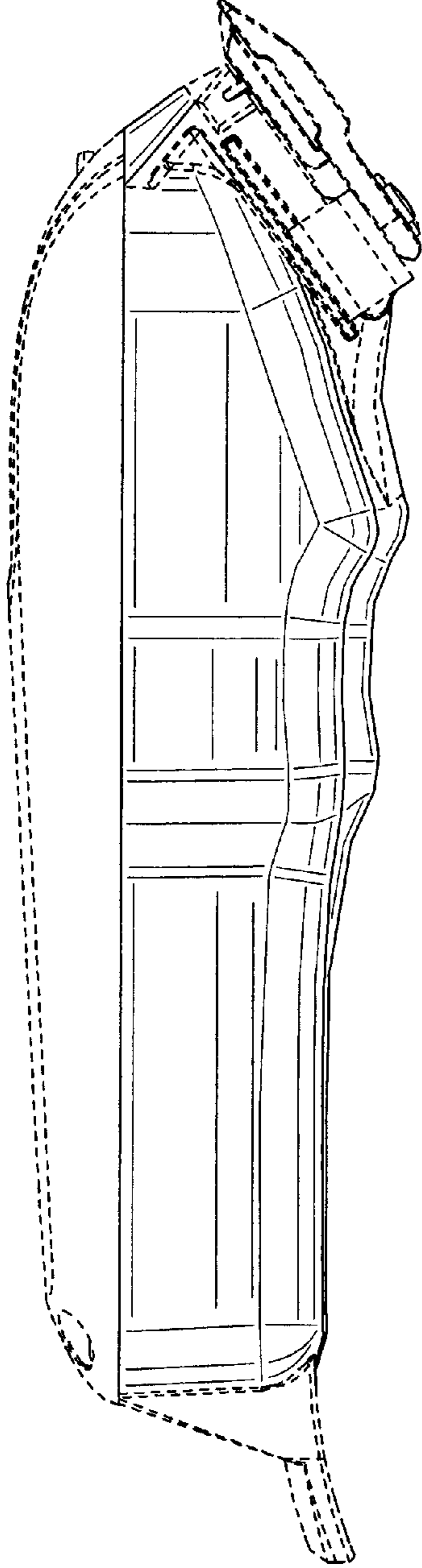

FIG. 4

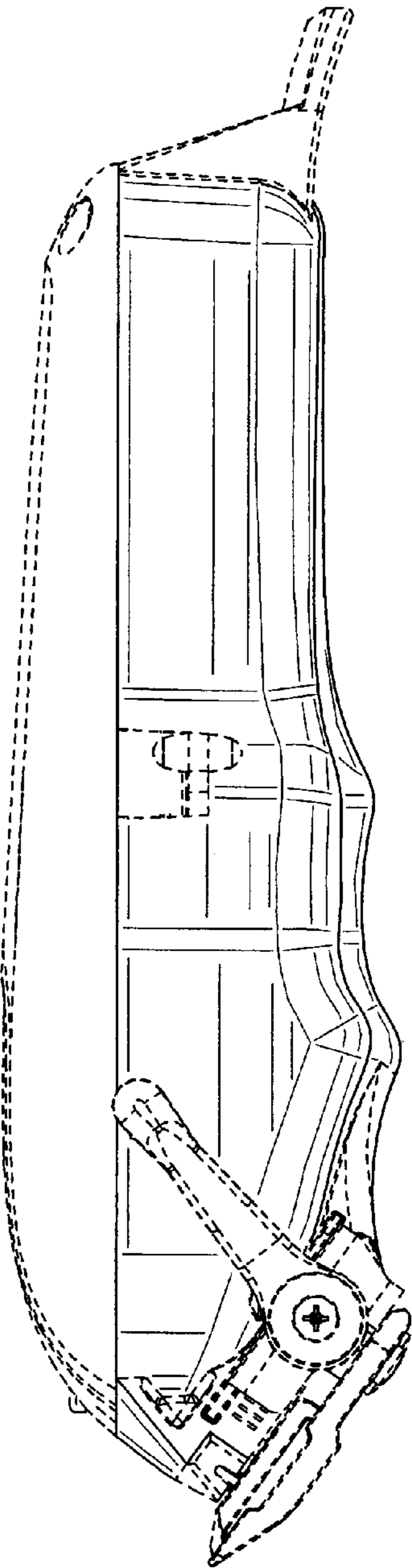

FIG. 5

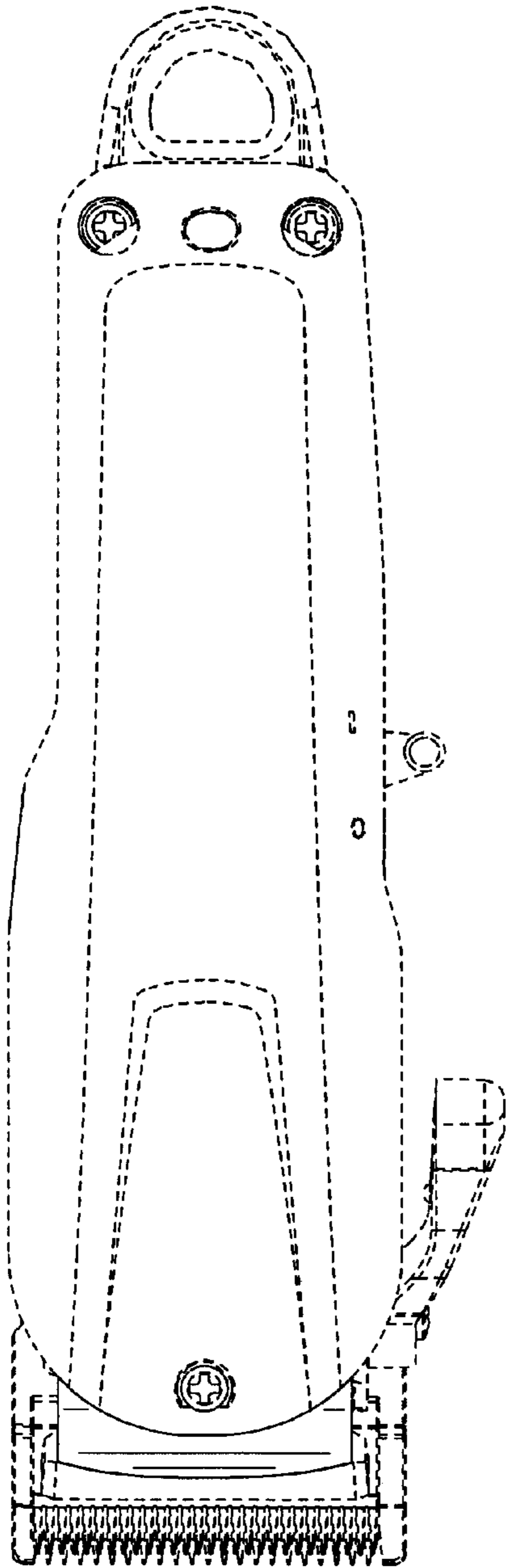

FIG. 6

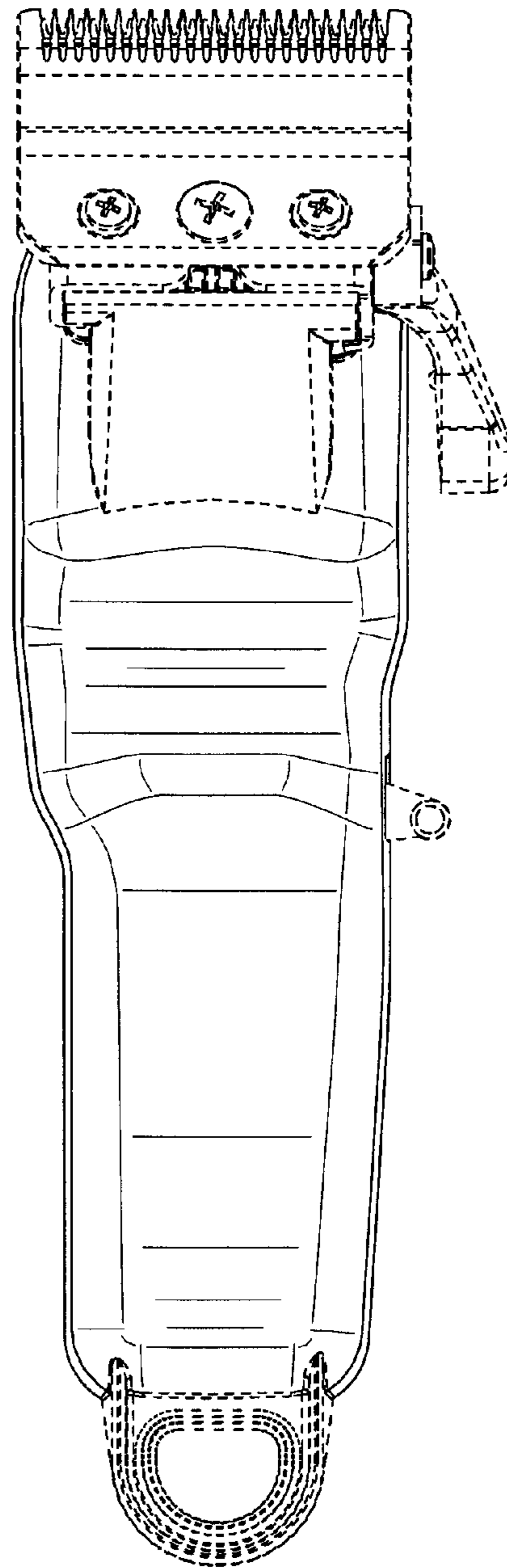

FIG. 7