



US00D715379S

(12) **United States Design Patent**  
**Kitamura**

(10) **Patent No.:** **US D715,379 S**  
(45) **Date of Patent:** **\*\* Oct. 14, 2014**

(54) **TOY ROBOT**

(75) Inventor: **Teruo Kitamura**, Tokyo (JP)

(73) Assignee: **Tomy Company, Ltd.** (JP)

(\*\*) Term: **14 Years**

(21) Appl. No.: **29/428,108**

(22) Filed: **Jul. 26, 2012**

(30) **Foreign Application Priority Data**

Jan. 27, 2012 (JP) ..... 2012-001607

(51) **LOC (10) Cl.** ..... **21-01**

(52) **U.S. Cl.**

CPC ..... **A63H 3/00** (2013.01)

USPC ..... **D21/578**

(58) **Field of Classification Search**

CPC ..... A63H 3/00

USPC ..... D21/578-583, 621, 622; 446/268-274,  
446/279, 280, 285, 289-292, 294, 297-303,  
446/353-355, 376-384; D15/199;  
318/568.11, 568.12, 568.2

See application file for complete search history.

(56) **References Cited**

**U.S. PATENT DOCUMENTS**

D288,830 S \* 3/1987 Obara ..... D21/579

D297,034 S \* 8/1988 Matsumoto ..... D21/580

D297,037 S \* 8/1988 Matsumoto ..... D21/580  
D301,261 S \* 5/1989 Ohno ..... D21/579  
D301,357 S \* 5/1989 Kunihiro ..... D21/580  
D303,410 S \* 9/1989 Shinohara ..... D21/580  
D305,053 S \* 12/1989 Doi ..... D21/584  
D307,776 S \* 5/1990 Shinohara ..... D21/584  
D307,778 S \* 5/1990 Shinohara ..... D21/584  
D311,041 S \* 10/1990 Shinohara ..... D21/580  
D622,786 S \* 8/2010 Lee ..... D21/578  
D662,154 S \* 6/2012 Hara et al. .... D21/578

\* cited by examiner

*Primary Examiner* — Zenia Bennett

(74) *Attorney, Agent, or Firm* — Cantor Colburn LLP

(57) **CLAIM**

The ornamental design for toy robot, as shown and described.

**DESCRIPTION**

FIG. 1 is a perspective view of a toy robot showing my new design;

FIG. 2 is a front elevational view thereof;

FIG. 3 is a rear elevational view thereof;

FIG. 4 is a left side elevational view thereof;

FIG. 5 is a right side elevational view thereof;

FIG. 6 is a top plane view thereof; and,

FIG. 7 is a bottom plane view thereof.

Broken lines in the drawing views are included for the purposes of illustrating the unclaimed portions of the toy robot and form no part of the claimed design.

**1 Claim, 7 Drawing Sheets**

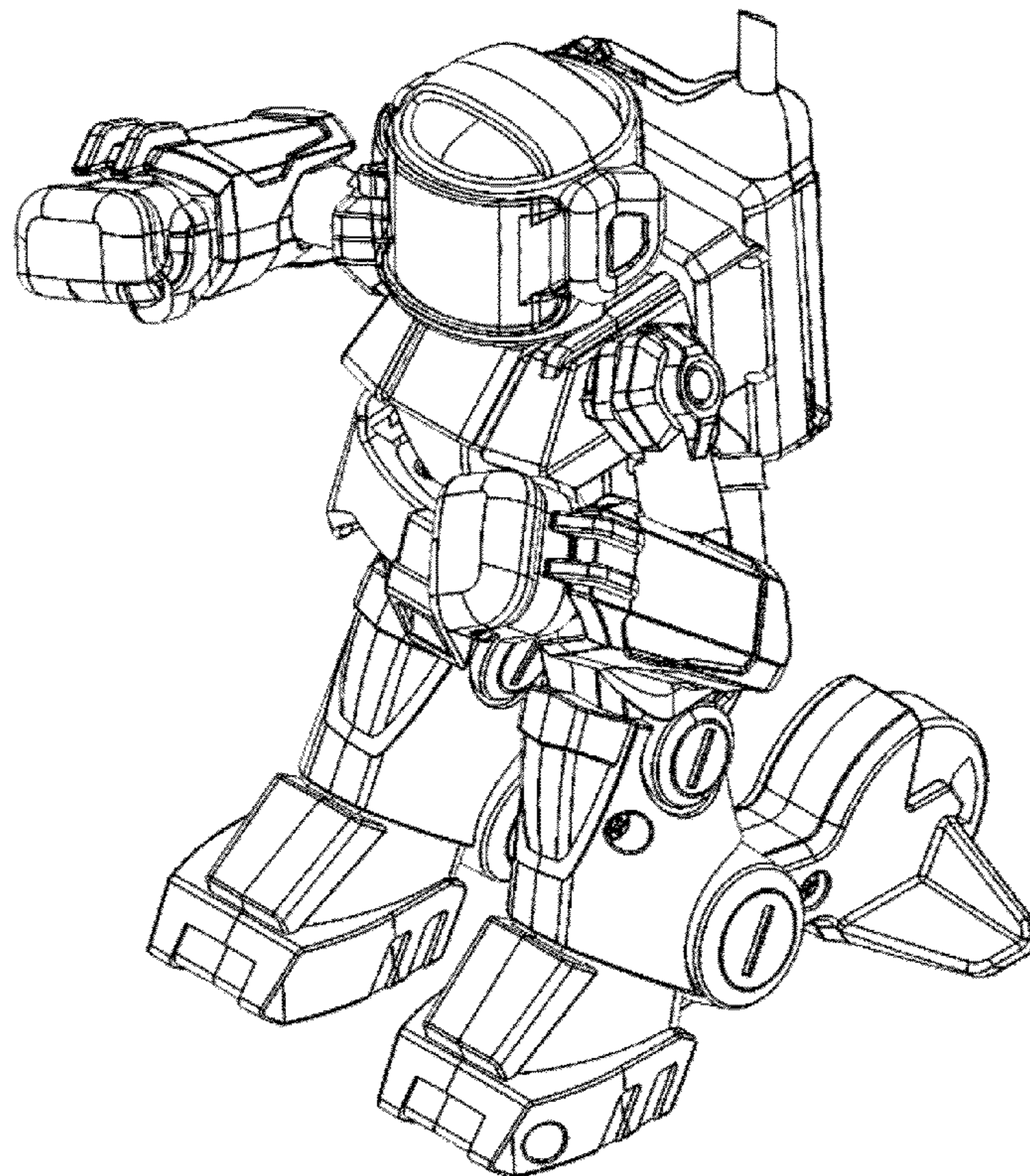

FIG. 1

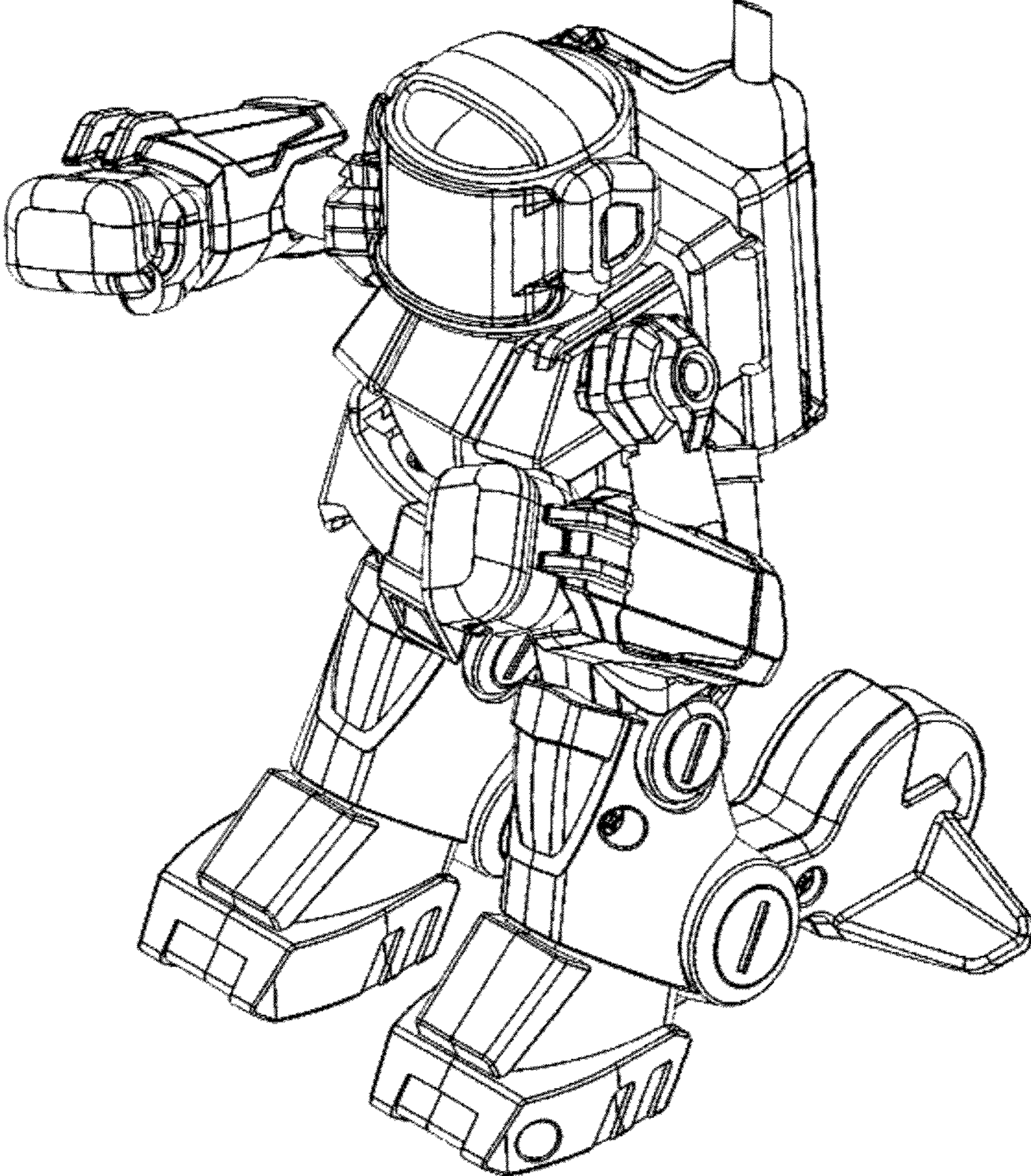

FIG. 2

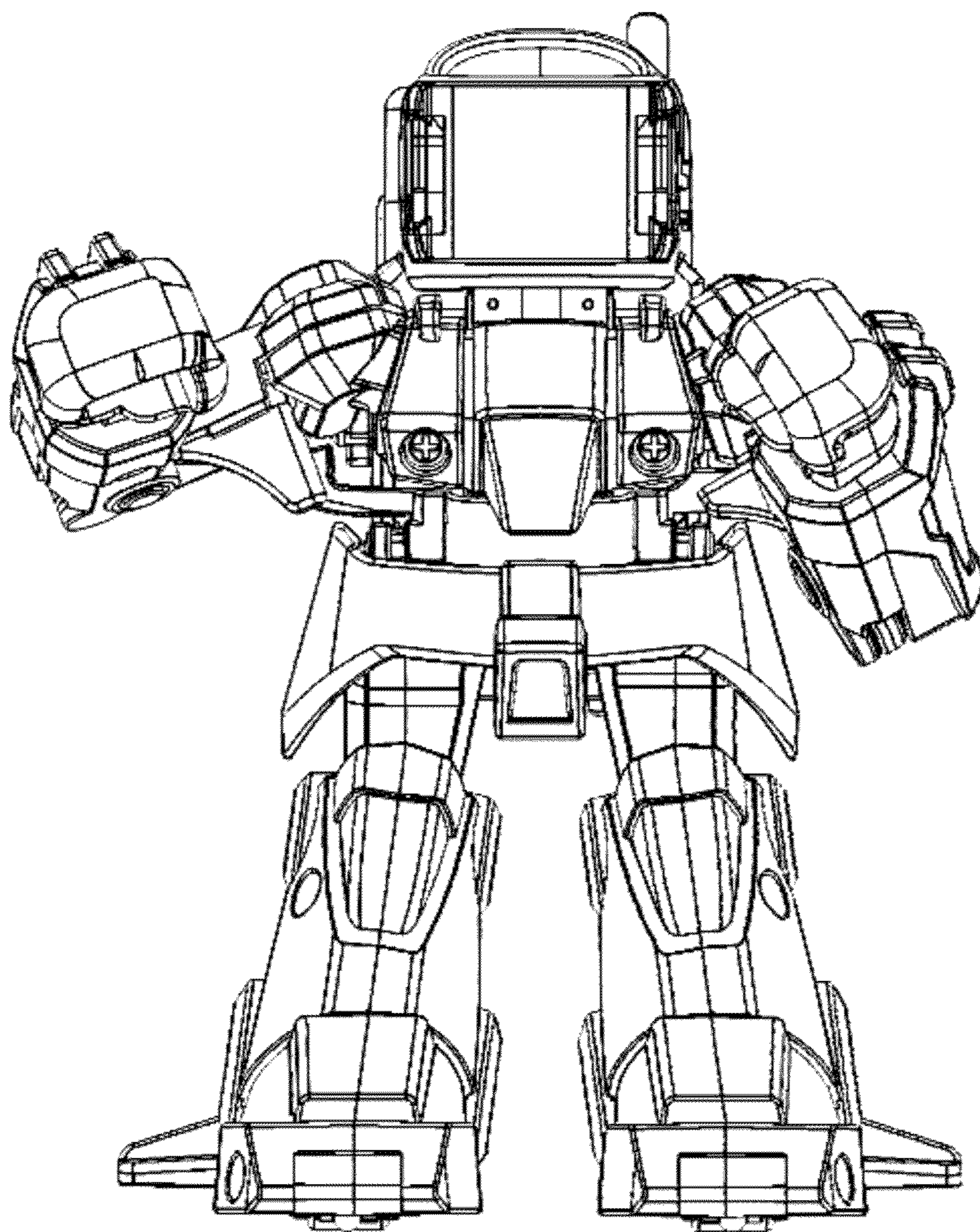

FIG. 3

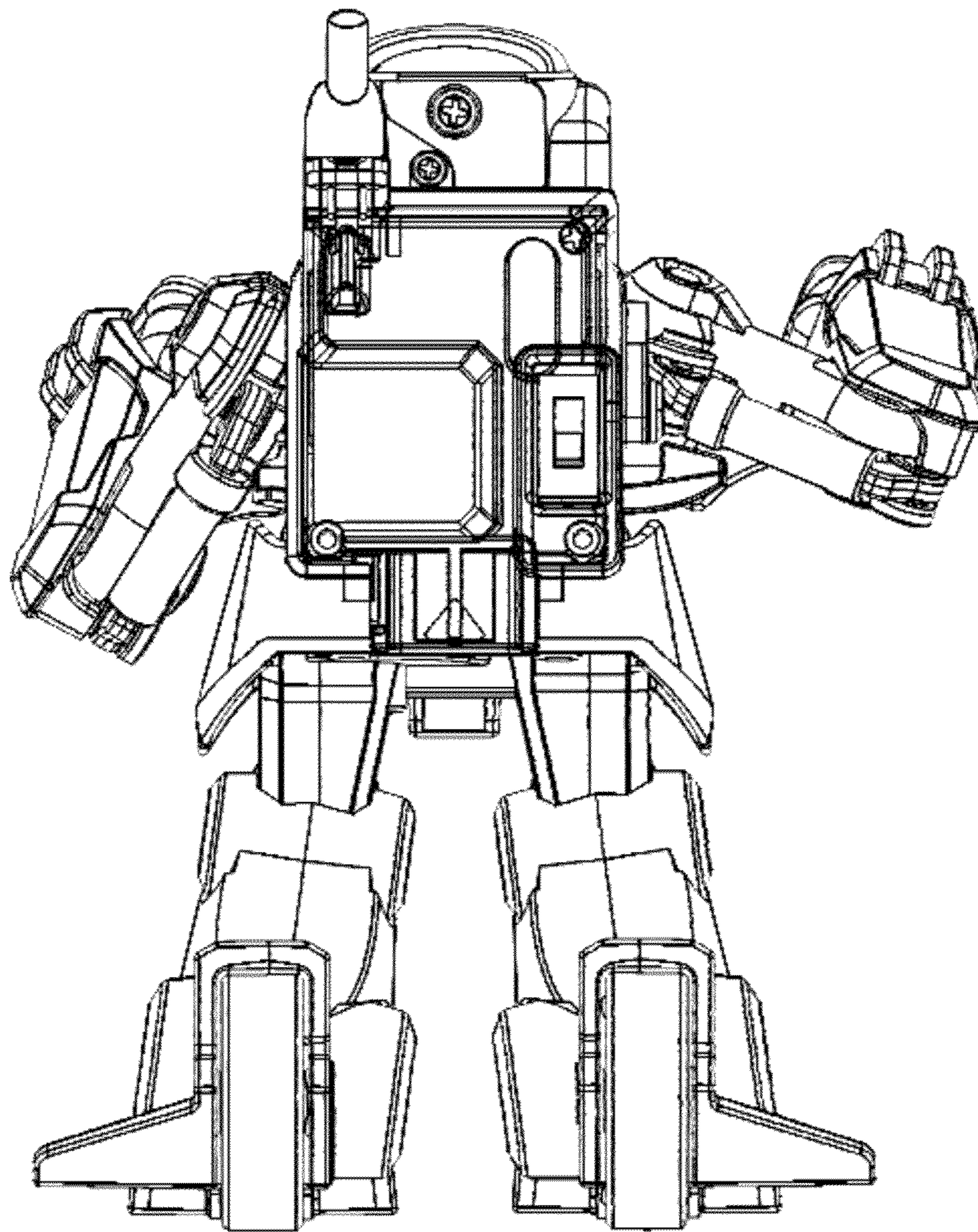

FIG. 4

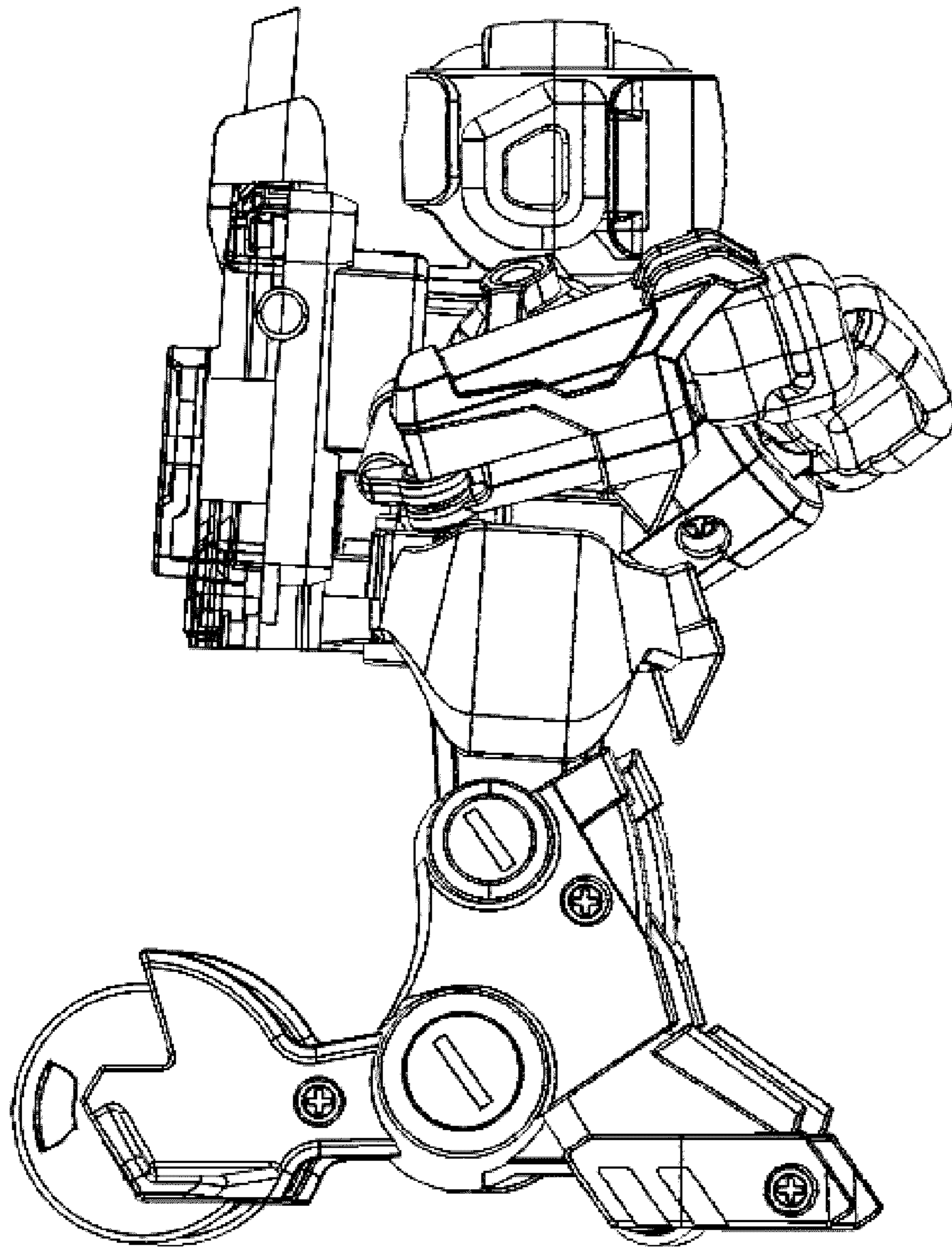

FIG. 5

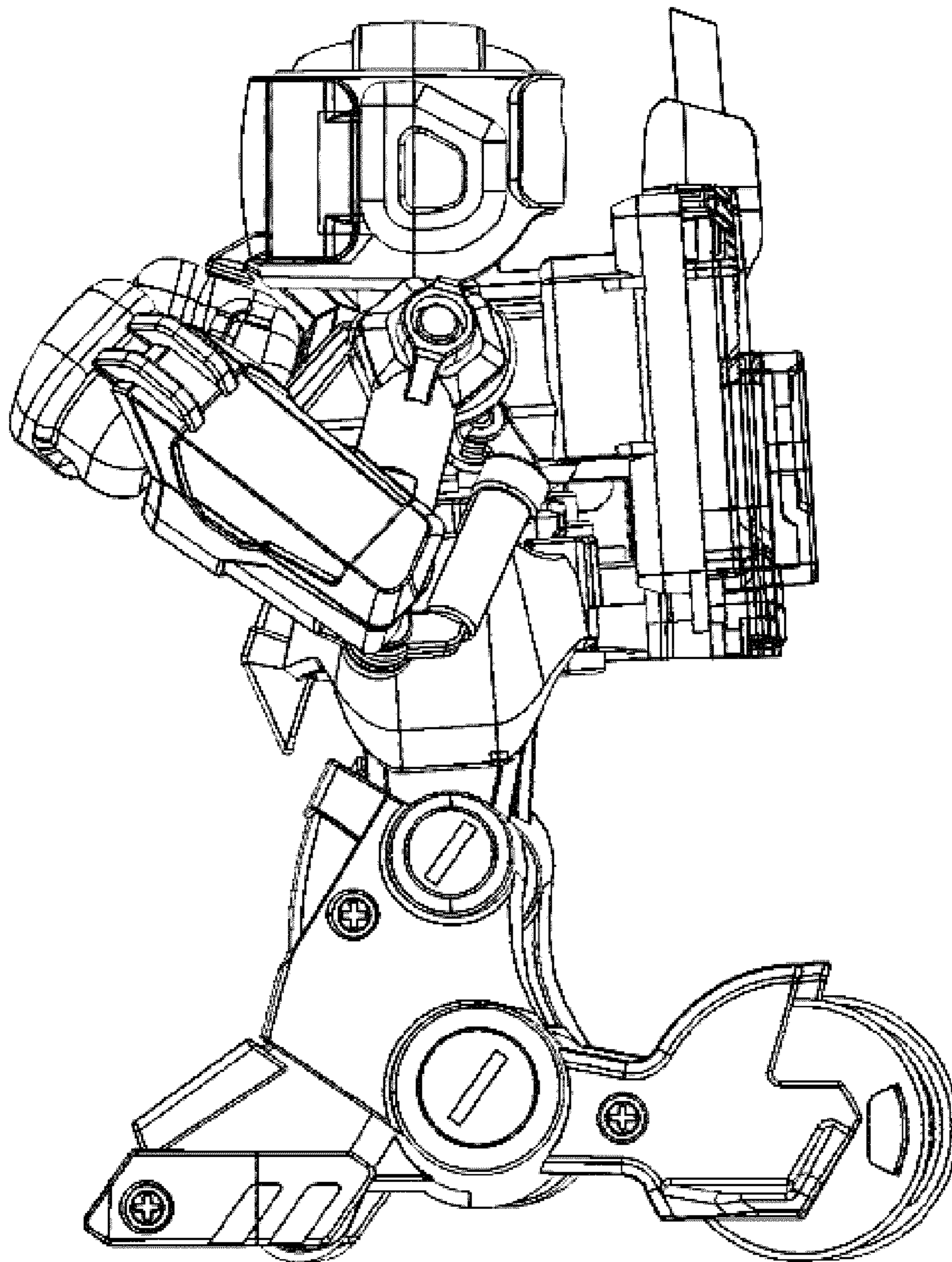

FIG. 6

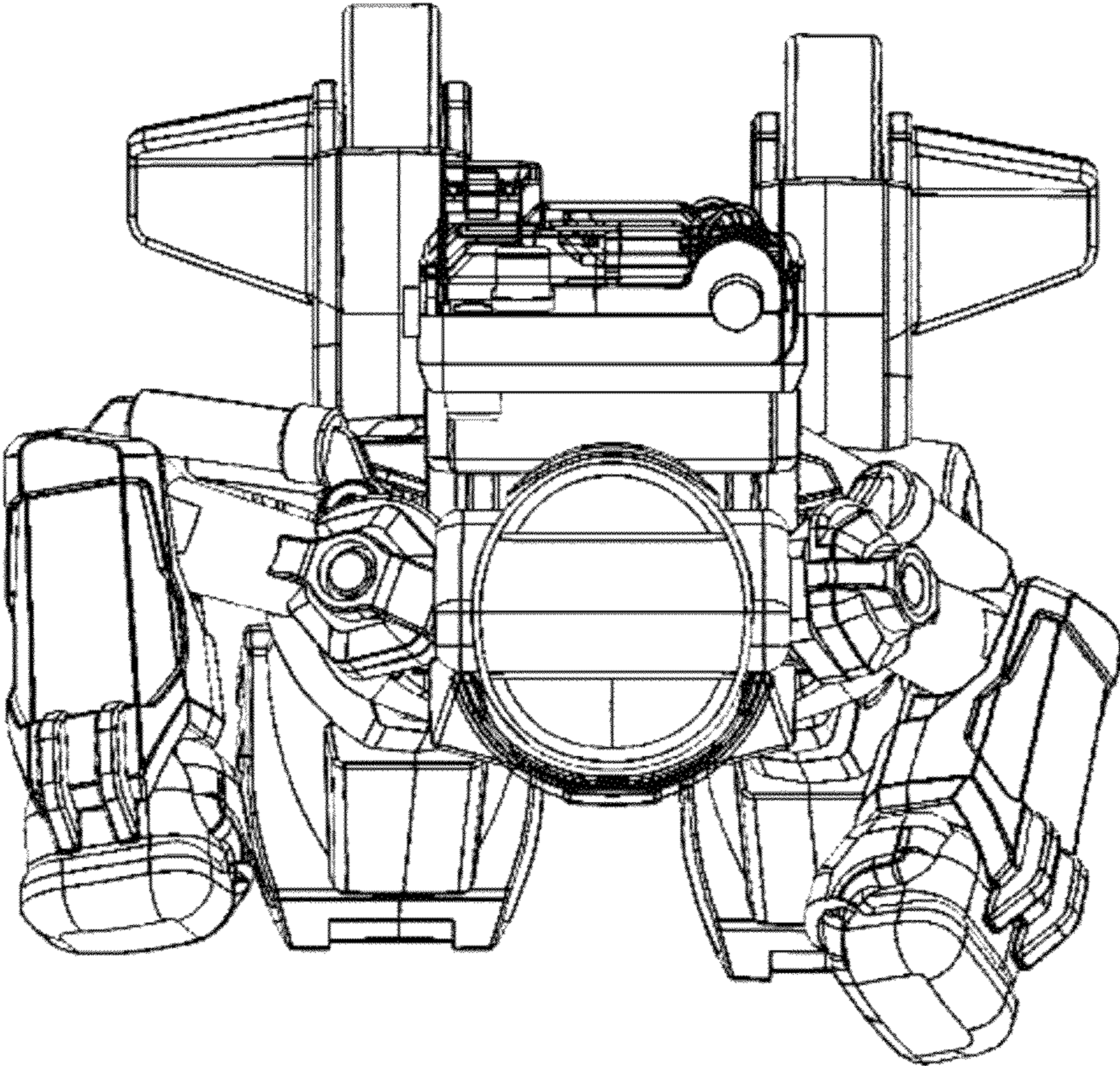

FIG. 7

