



US00D715366S

(12) **United States Design Patent**  
**Pamphilis**

(10) **Patent No.:** **US D715,366 S**

(45) **Date of Patent:** **\*\* Oct. 14, 2014**

(54) **BINGO STATION**

(71) Applicant: **John Harry Pamphilis**, South  
Pasadena, CA (US)

(72) Inventor: **John Harry Pamphilis**, South  
Pasadena, CA (US)

(\*\*) Term: **14 Years**

(21) Appl. No.: **29/447,122**

(22) Filed: **Feb. 28, 2013**

(51) **LOC (10) Cl.** ..... **21-01**

(52) **U.S. Cl.**  
USPC ..... **D21/392**

(58) **Field of Classification Search**  
USPC ..... D21/307-308, 334-368, 376-397;  
273/236-287, 288-291; D19/88;  
248/459, 460; D6/312  
See application file for complete search history.

(56) **References Cited**

**U.S. PATENT DOCUMENTS**

5,120,069 A \* 6/1992 Shaw ..... 273/309  
D333,160 S \* 2/1993 Collins ..... D19/88

5,286,025 A \* 2/1994 Mulyca et al. .... 273/148 R  
D433,463 S \* 11/2000 Dalbo ..... D21/394  
6,213,439 B1 \* 4/2001 Giulie et al. .... 248/459  
D534,730 S \* 1/2007 Hardy ..... D6/312  
2002/0162935 A1 \* 11/2002 Hardy ..... 248/460

\* cited by examiner

*Primary Examiner* — George D Kirschbaum

(74) *Attorney, Agent, or Firm* — Grant's Law firm; Allan Grant

(57) **CLAIM**

I claim the ornamental design for a bingo station, as shown and as described.

**DESCRIPTION**

FIG. 1 is a perspective overhead view of the bingo station.  
FIG. 2 is a perspective side view of the bingo station.  
FIG. 3 is the front view of the bingo station.  
FIG. 4 is a back view of the bingo station.  
FIG. 5 is a side view of the bingo station.  
FIG. 6 is the other side view of the bingo station.  
FIG. 7 is a top view of the bingo station; and,  
FIG. 8 is bottom view of the bingo station.

**1 Claim, 6 Drawing Sheets**

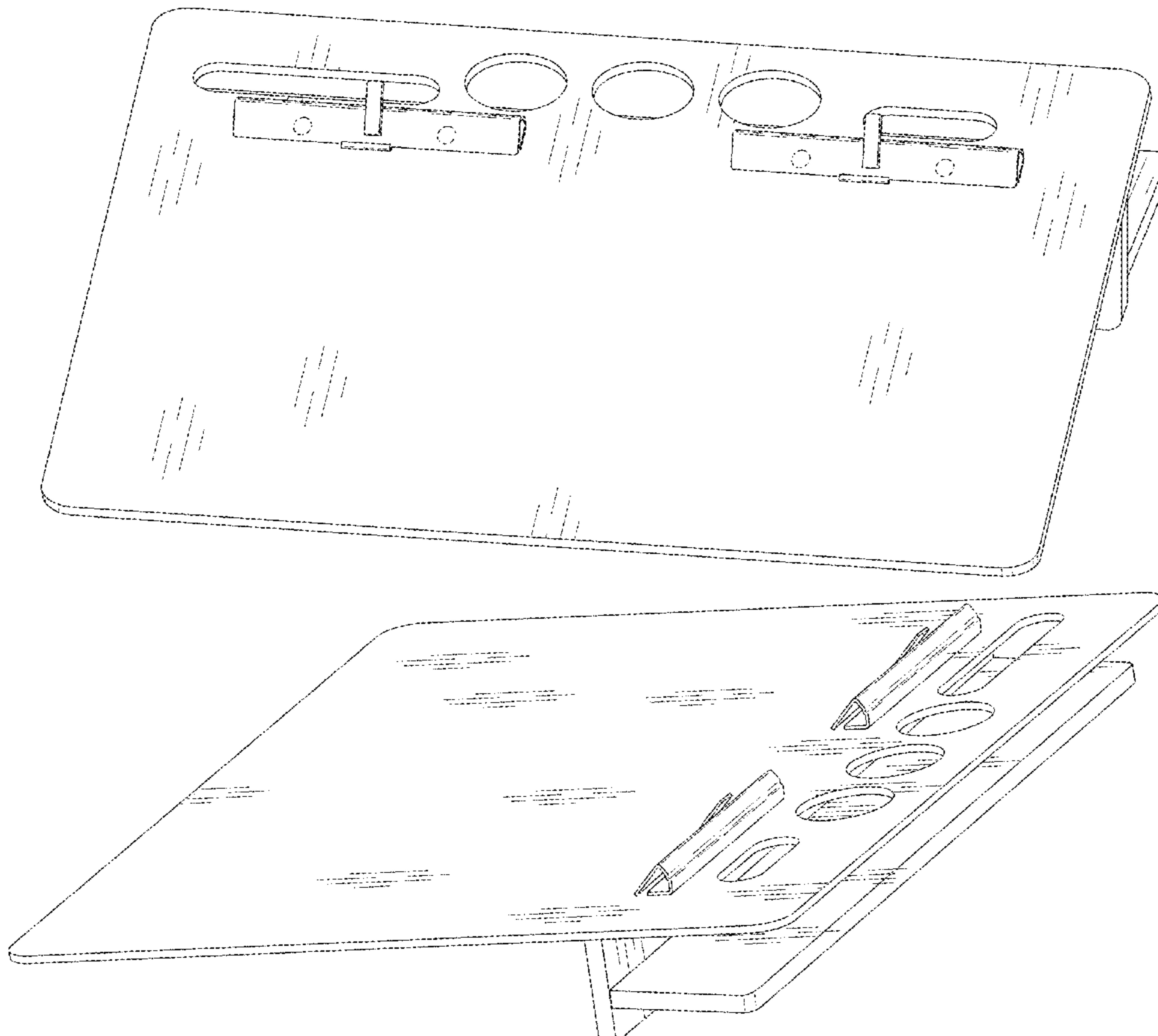

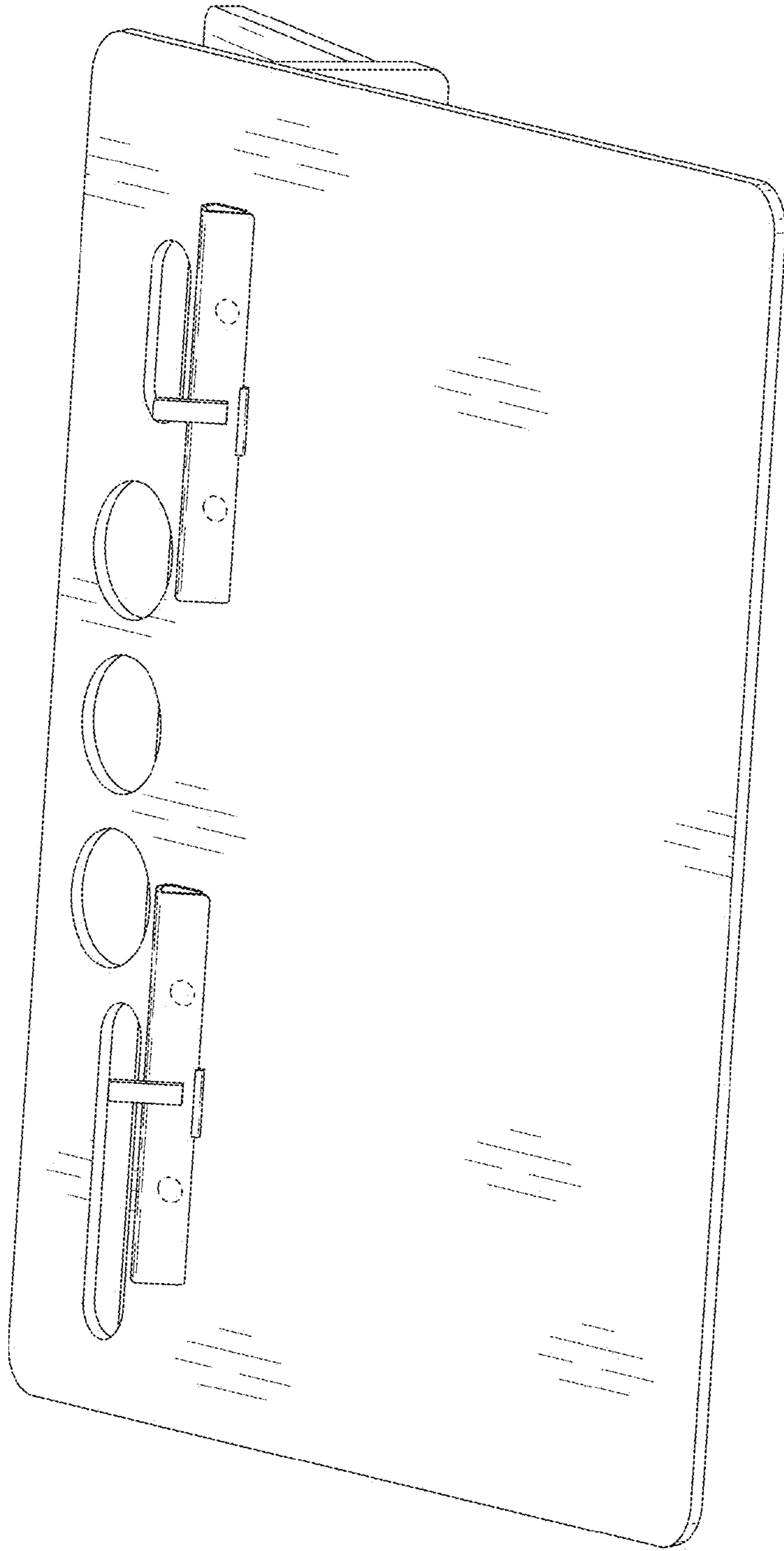

Fig. 1

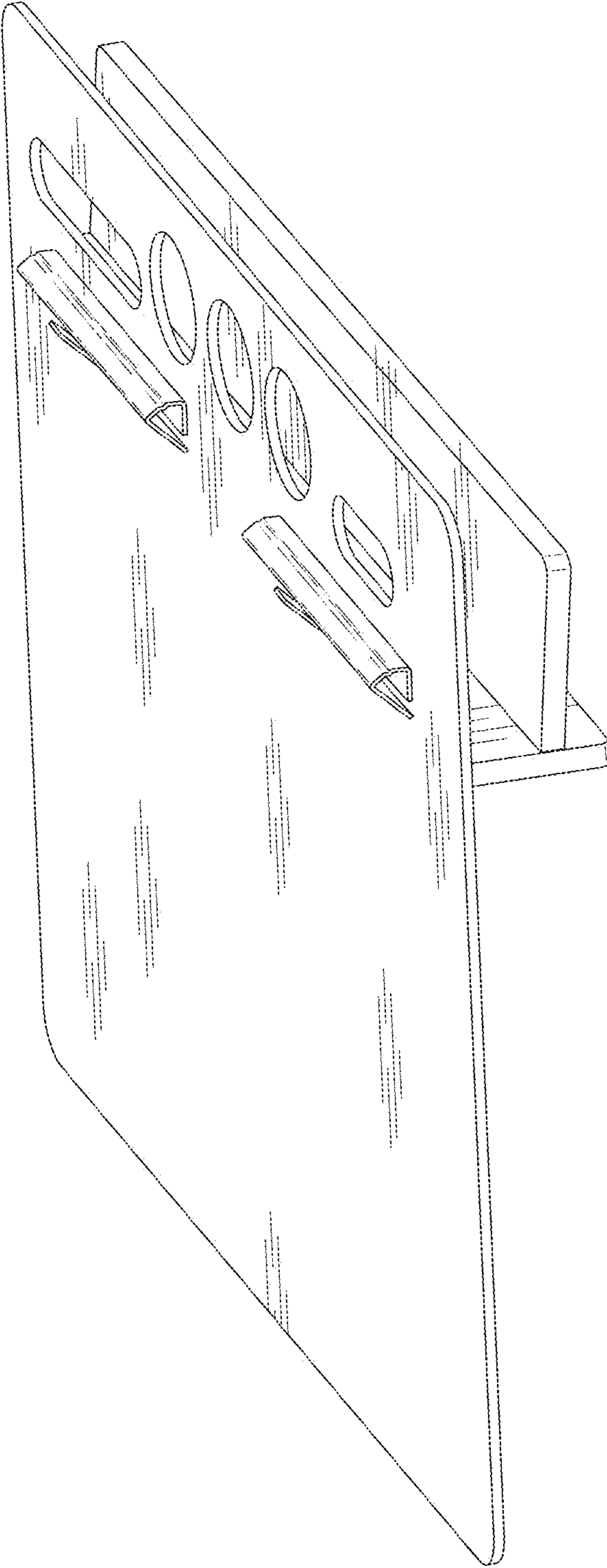
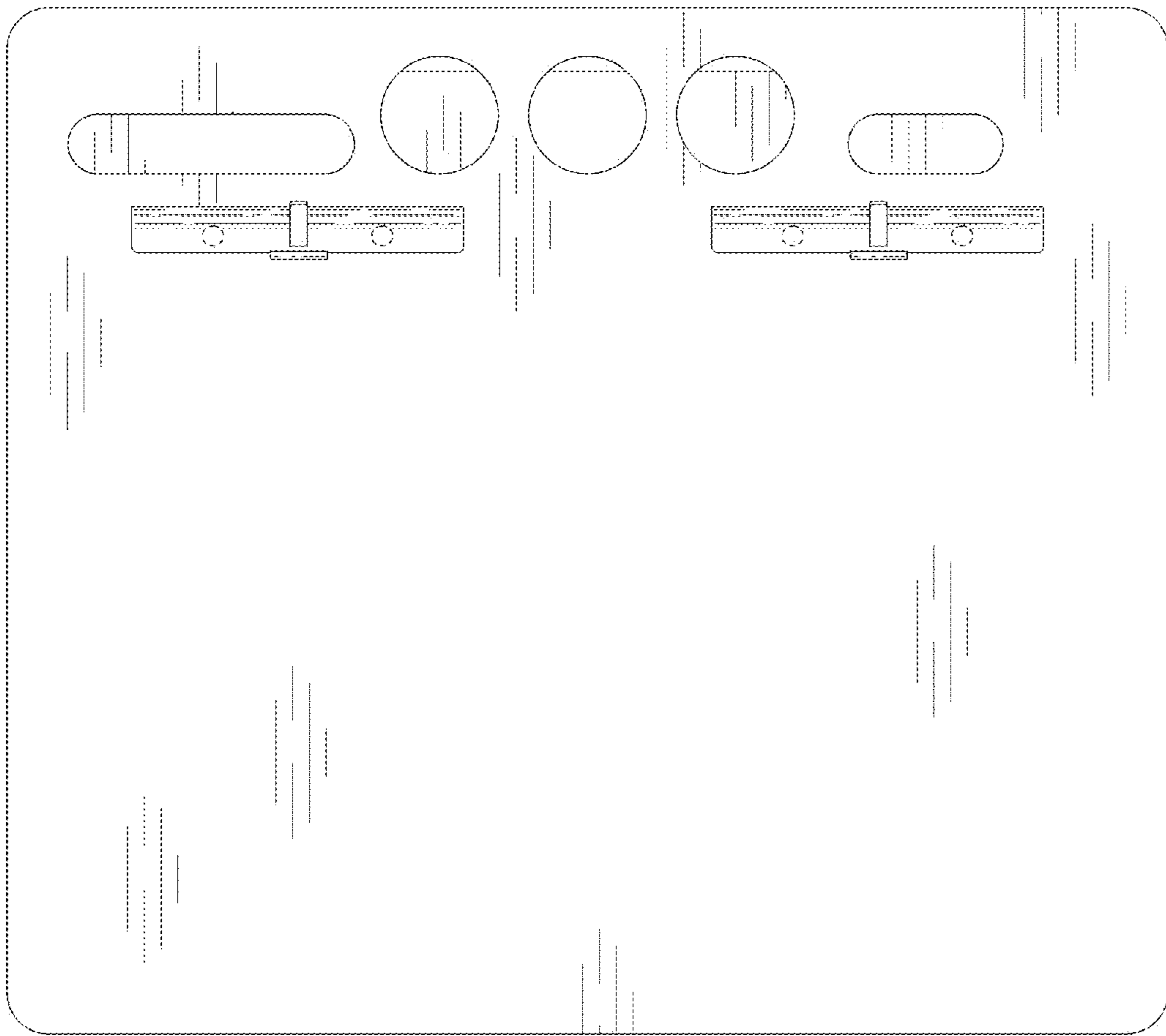
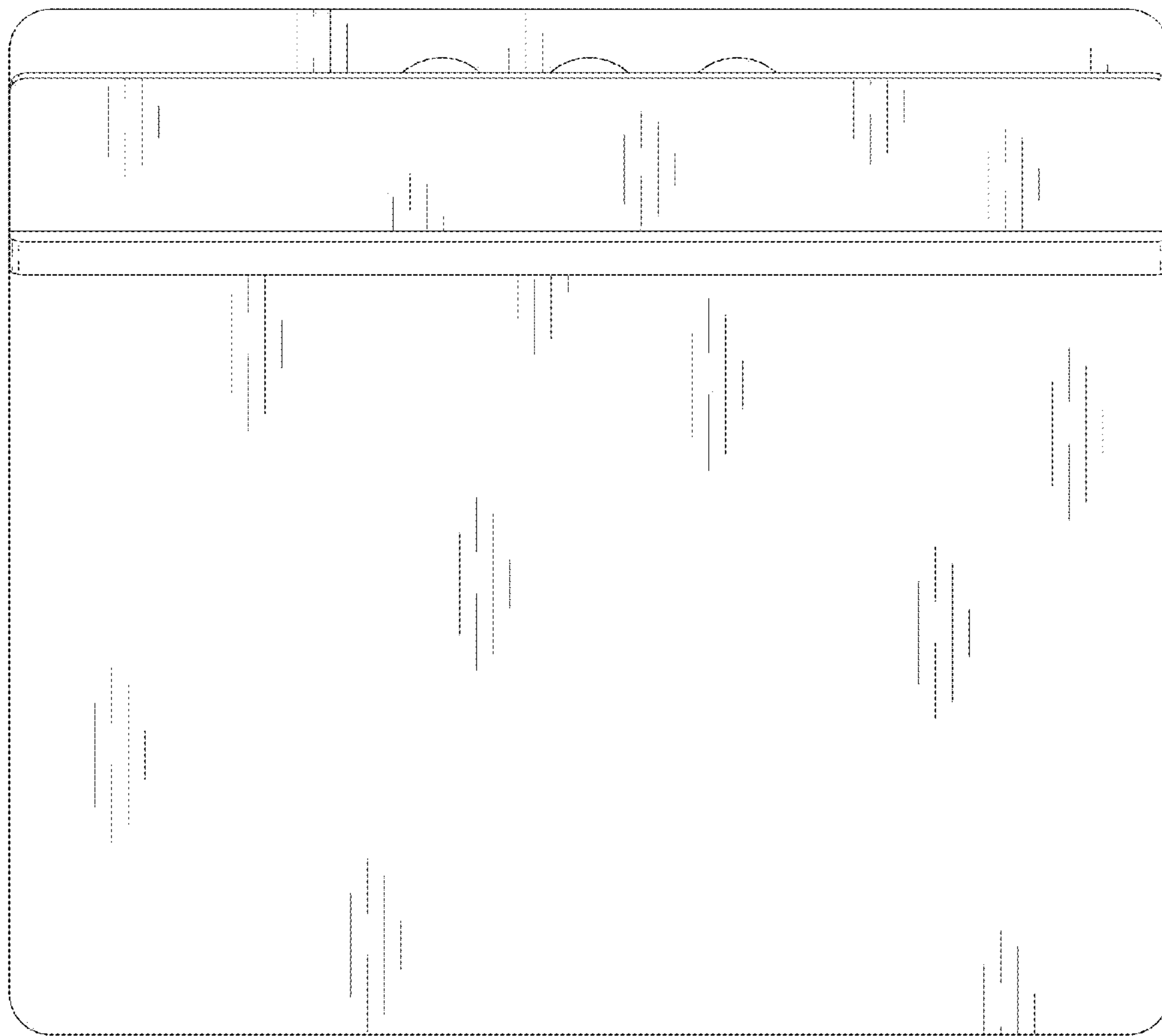

Fig. 2



*Fig. 3*



*Fig. 4*

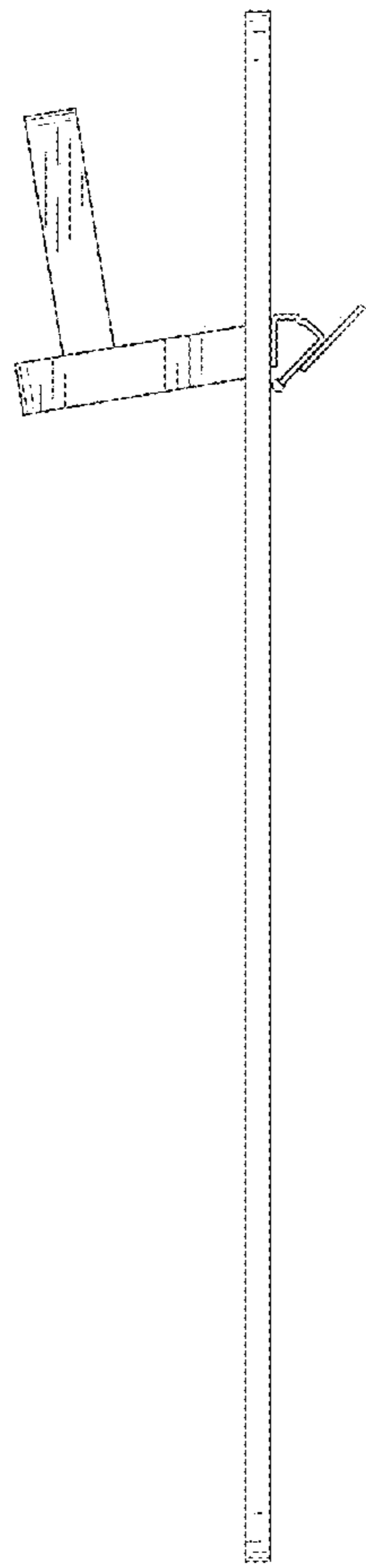

*Fig. 5*

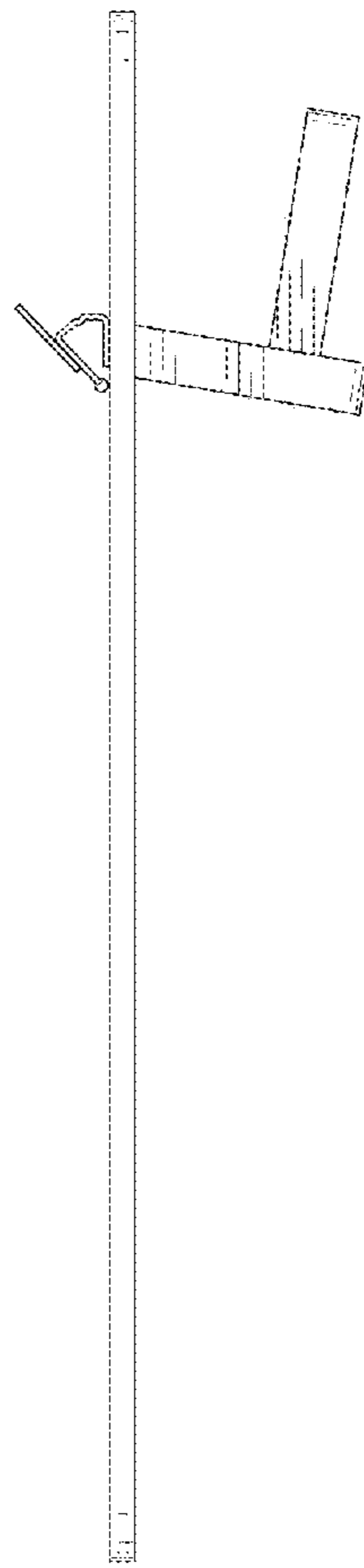

*Fig. 6*

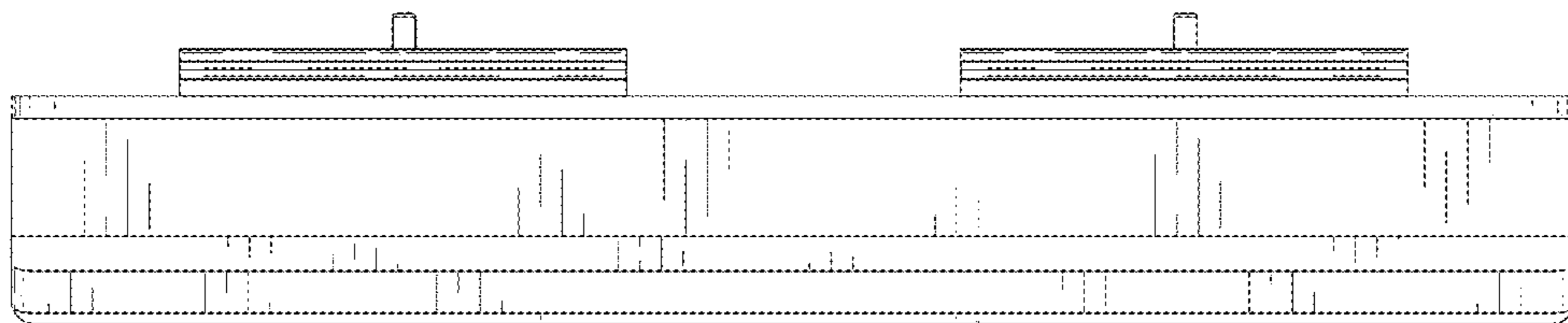

*Fig. 7*

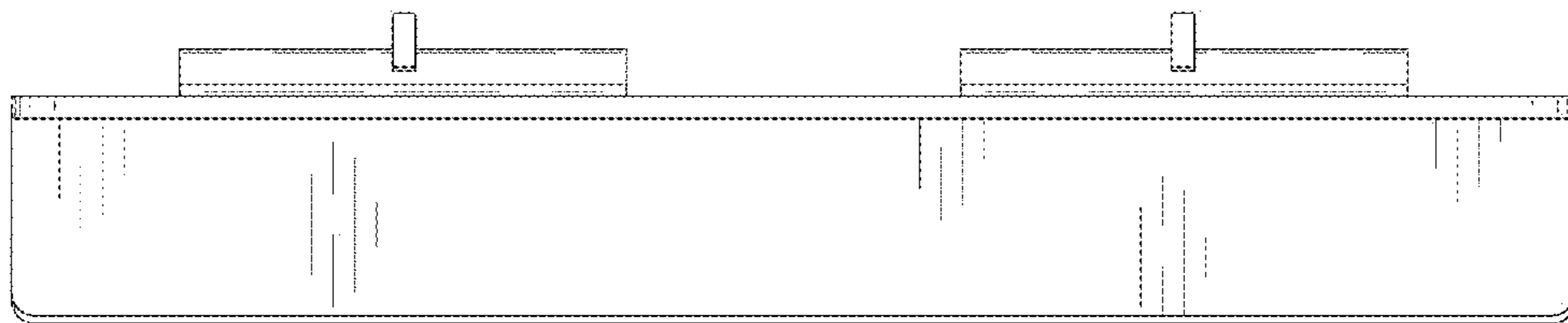

*Fig. 8*