



US00D715308S

(12) **United States Design Patent**
Fujioka

(10) **Patent No.:** **US D715,308 S**
(45) **Date of Patent:** **** Oct. 14, 2014**

- (54) **TABLET STAND**
- (71) Applicant: **Robb Fujioka**, Manhattan Beach, CA
(US)
- (72) Inventor: **Robb Fujioka**, Manhattan Beach, CA
(US)
- (**) Term: **14 Years**
- (21) Appl. No.: **29/486,056**
- (22) Filed: **Mar. 26, 2014**
- (51) **LOC (10) Cl.** **08-03**
- (52) **U.S. Cl.**
USPC **D14/447**
- (58) **Field of Classification Search**
CPC G09F 2003/0266; G09F 2001/085;
G09F 5/00; G09F 1/10; G09F 1/08; A47B
2097/005; A47B 2097/006; A47B 21/04;
A47B 2021/00; A47B 23/00; A47B 23/043;
A47B 2021/0314; A47B 2021/0307; A47B
2023/005; A47B 2023/049; F16M 13/00;
F16M 2200/00; H04B 1/3888; H04M 1/04;
H04M 1/185; A45C 13/002
USPC D14/447, 432, 433, 434, 439, 440, 451,
D14/452, 457, 459, 460, 461, 251, 253, 448,
D14/449, 450; D9/433, 455, 457; D20/10,
D20/25; D6/672, 674, 674.1, 678, 682,
D6/682.3; 40/124.05, 124.06, 124.07,
40/124.08, 124.09, 124.14, 124.16, 539;
248/917-924, 445, 447.1, 451, 456,
248/459, 460, 150, 152, 174, 188.6, 176.1;
361/679.02, 679.09, 679.21, 679.26,
361/679.3, 679.27, 679.55, 679.56
See application file for complete search history.

- 2,187,721 A * 1/1940 Wolfson 40/539
- D264,817 S * 6/1982 Austin D9/433
- D266,989 S * 11/1982 Herwood D9/457
- 5,010,669 A * 4/1991 Moran 40/539
- 5,317,823 A * 6/1994 Brunt, II 40/124.08
- 5,564,208 A * 10/1996 Bergman 40/539
- 5,592,768 A * 1/1997 Testa 40/786
- 5,888,595 A * 3/1999 Krattiger 428/12
- 5,983,538 A * 11/1999 Crowell 40/124.14
- D426,725 S * 6/2000 Baharouzi D6/450
- D428,736 S * 8/2000 Aloisi D6/453
- 6,382,581 B1 * 5/2002 Duff 248/459
- D536,615 S * 2/2007 Dziaba et al. D9/455
- 7,182,305 B2 * 2/2007 Dempsey 248/459
- D537,827 S * 3/2007 Florindo D14/450
- 7,418,794 B2 * 9/2008 Kittrell, III 40/124.16
- D639,814 S * 6/2011 Farris-Gilbert et al. D14/447
- D643,635 S * 8/2011 Harding D6/310
- D651,213 S * 12/2011 Magness et al. D14/447
- D661,310 S * 6/2012 Belongia et al. D14/447

(Continued)

Primary Examiner — Angela J Lee

(74) Attorney, Agent, or Firm — Steptoe & Johnson LLP

(57) **CLAIM**

The ornamental design for a tablet stand, as shown and described.

DESCRIPTION

FIG. 1 is a top, front, right side, perspective view of my design;
 FIG. 2 is front elevation view;
 FIG. 3 is a rear elevation view;
 FIG. 4 is a left side elevation view;
 FIG. 5 is a right side elevation view;
 FIG. 6 is a top plan view;
 FIG. 7 is a bottom plan view; and,
 FIG. 8 is a view of the tablet stand in a flat, unfolded position.
 The broken lines shown in the drawings represent portions of the tablet stand and a tablet that form no part of the claimed design.

1 Claim, 3 Drawing Sheets

(56) **References Cited**
U.S. PATENT DOCUMENTS

- 1,656,620 A * 1/1928 Cossenias 40/539
- D118,010 S * 12/1939 Broderick D9/415

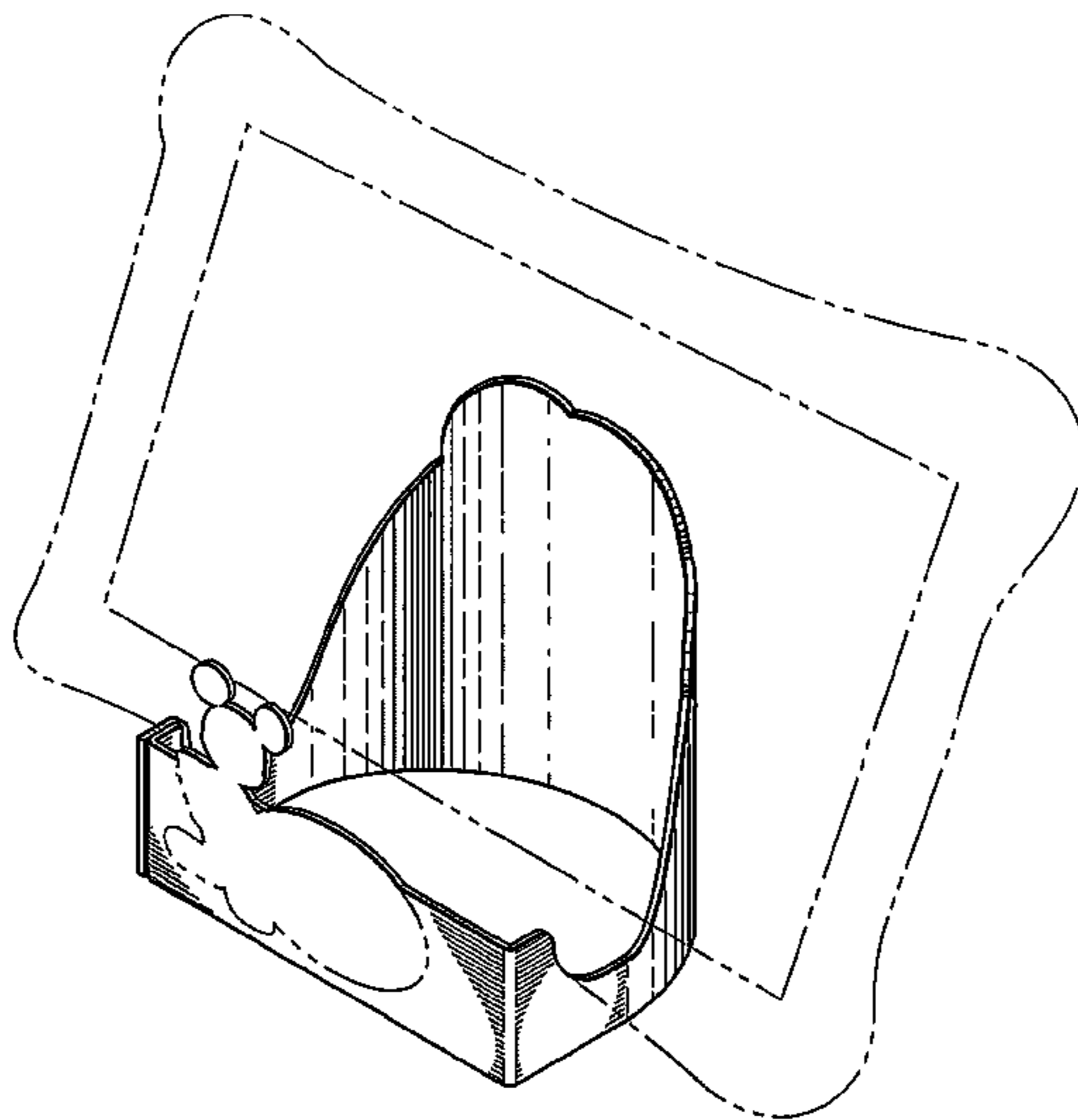

US D715,308 S

Page 2

(56)

References Cited

U.S. PATENT DOCUMENTS

D674,396 S *	1/2013	Yang et al.	D14/447
8,424,831 B2 *	4/2013	Lin	248/460
2013/0026329 A1 *	1/2013	Lane et al.	248/459
D667,004 S *	9/2012	Goodrich	D14/253

* cited by examiner

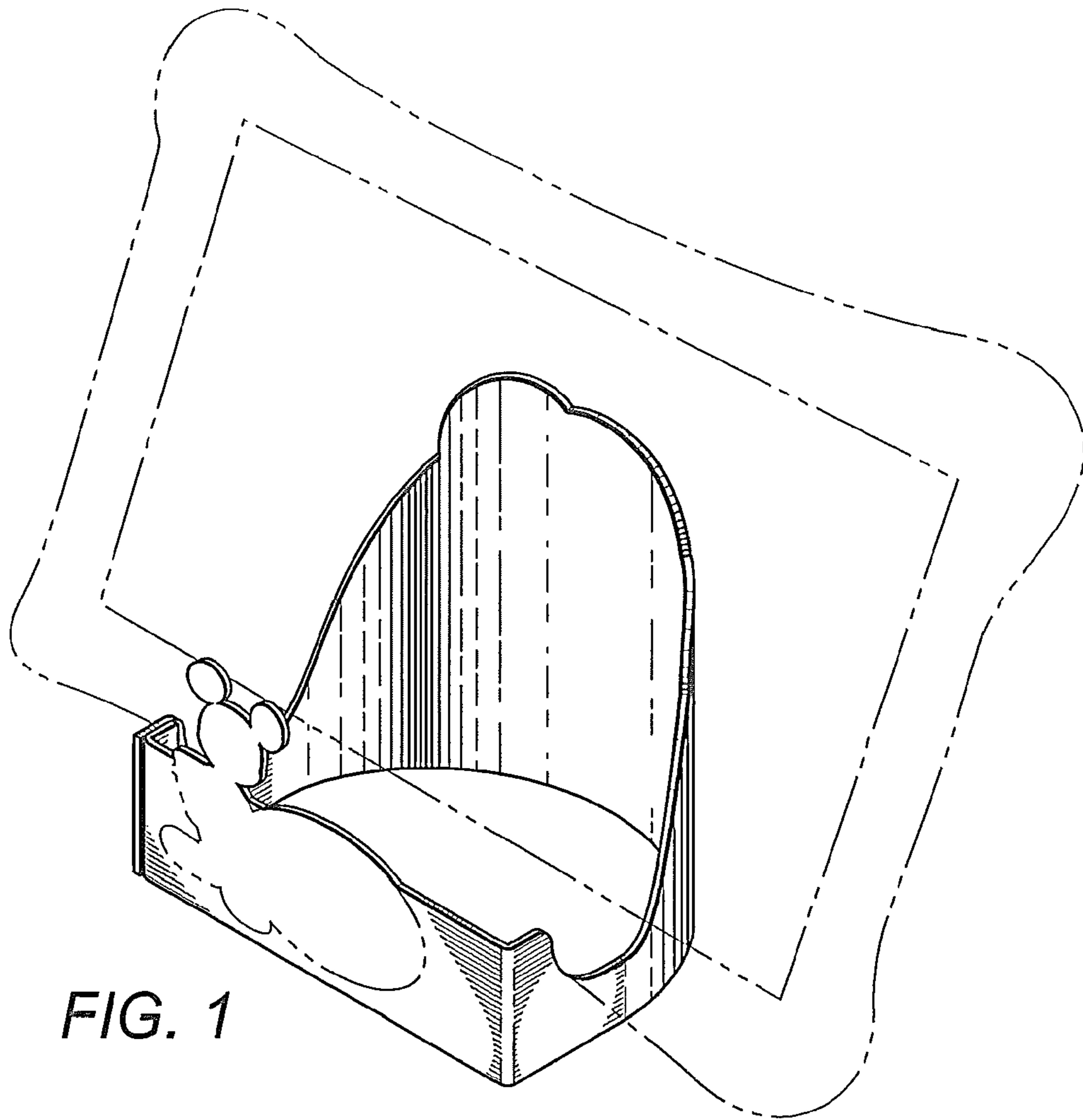

FIG. 1

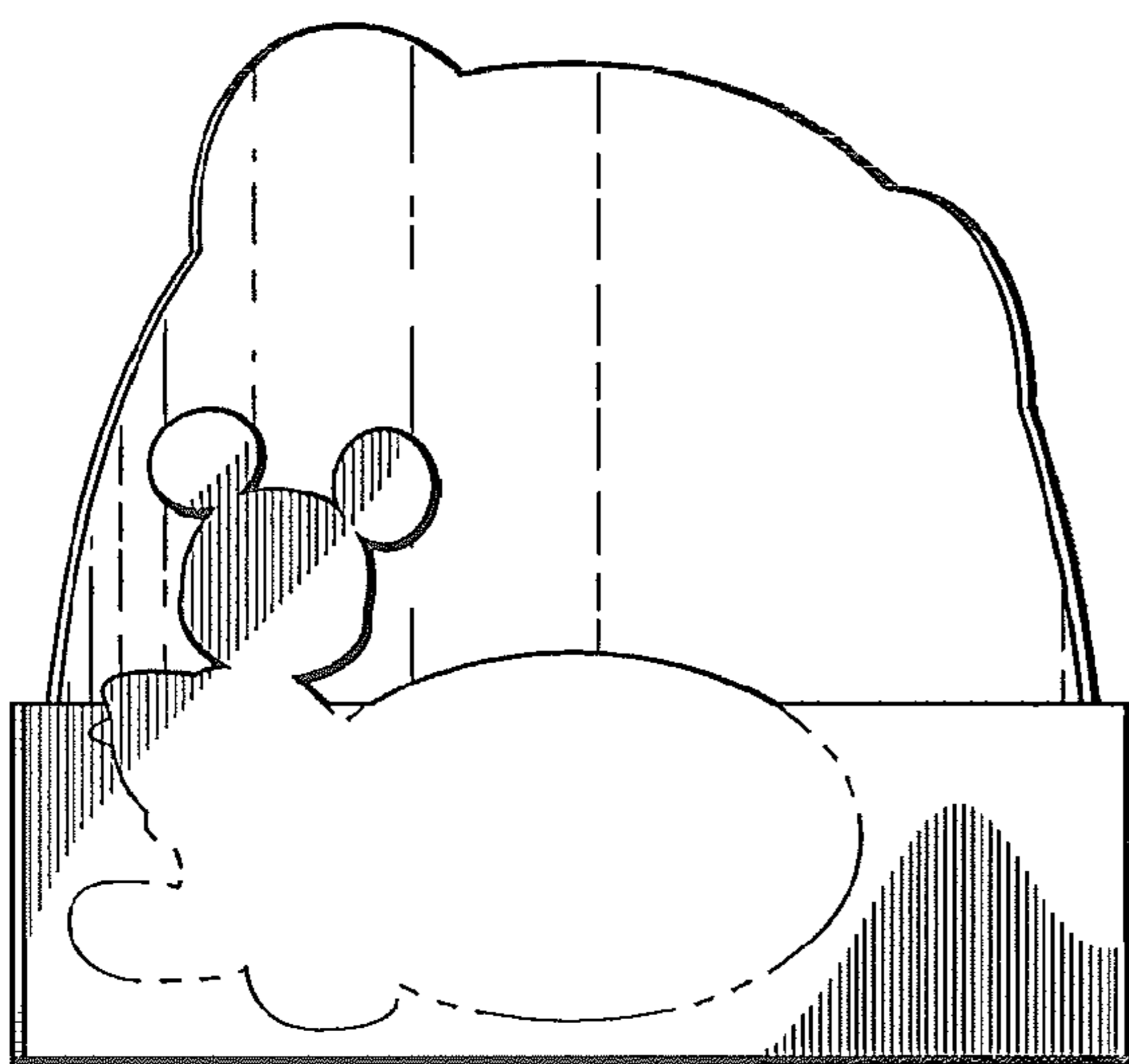

FIG. 2

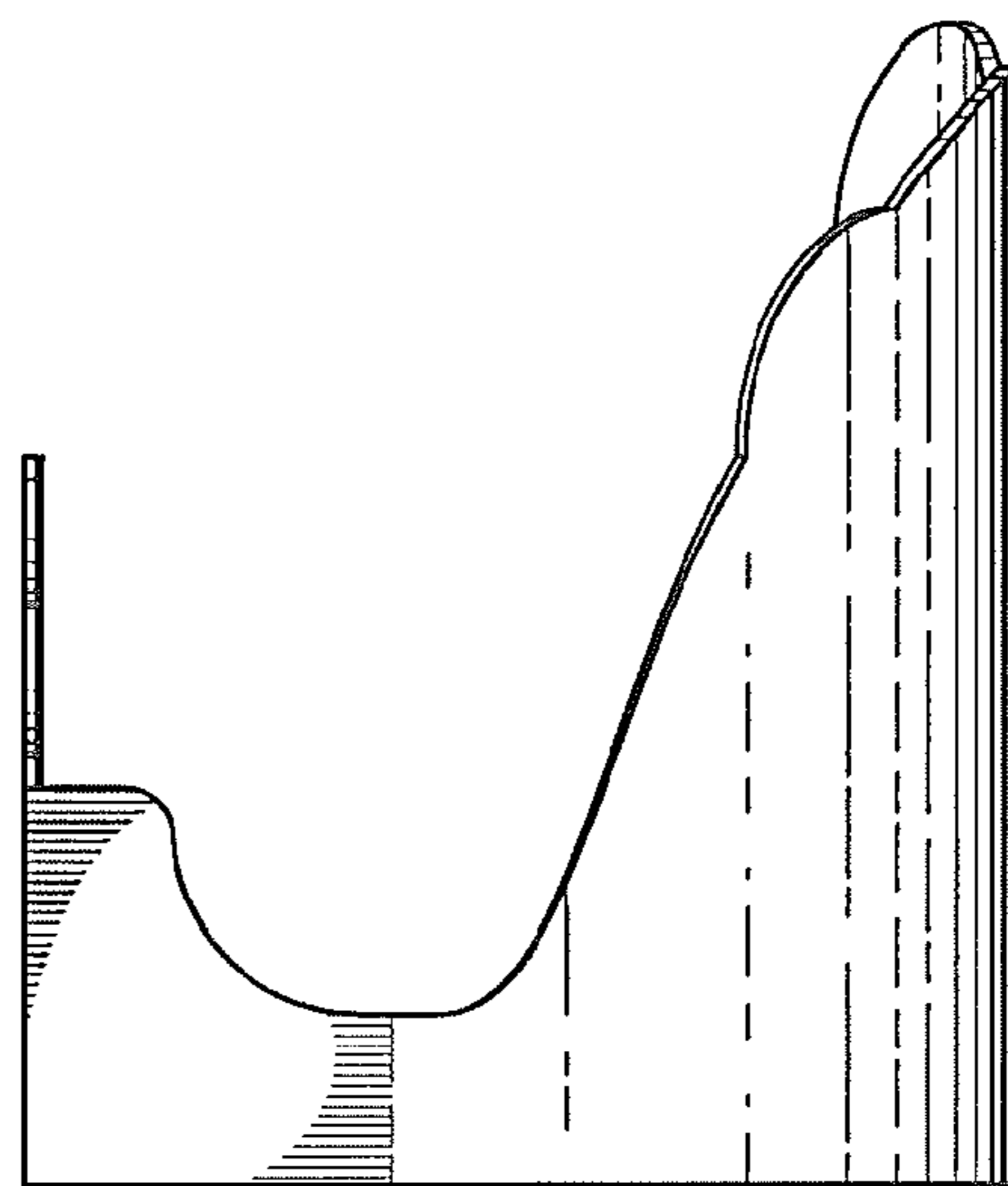

FIG. 5

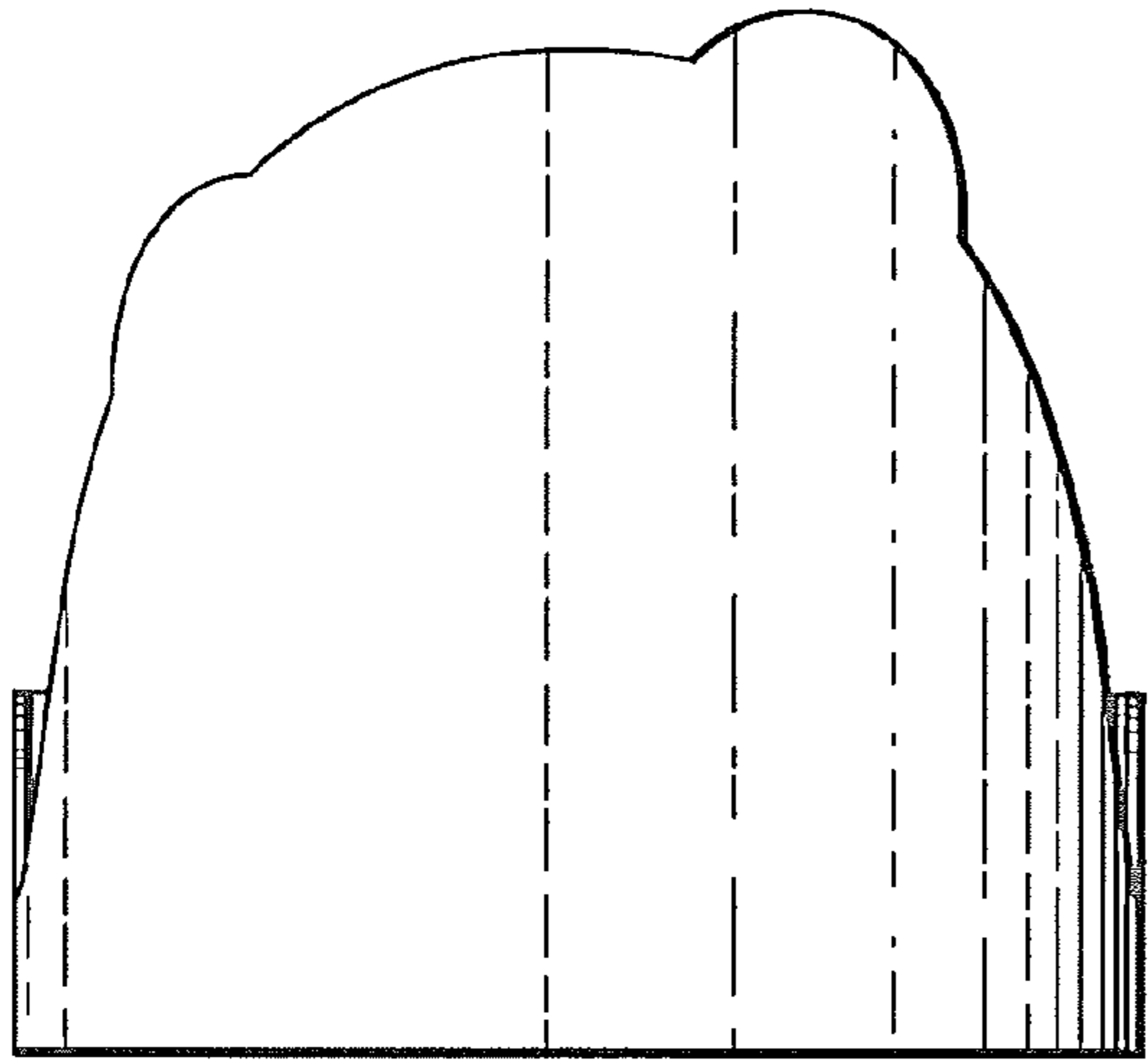

FIG. 3

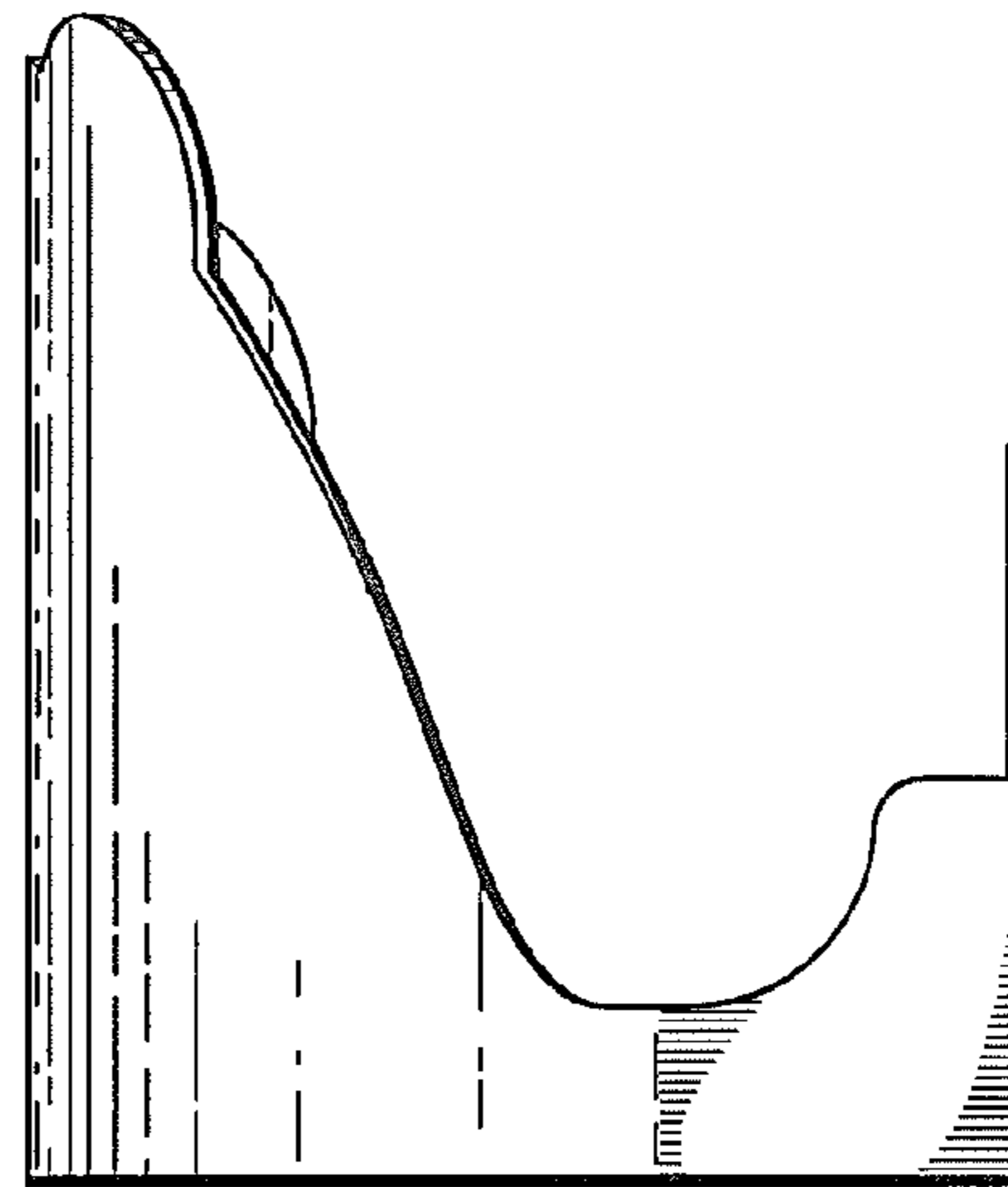

FIG. 4

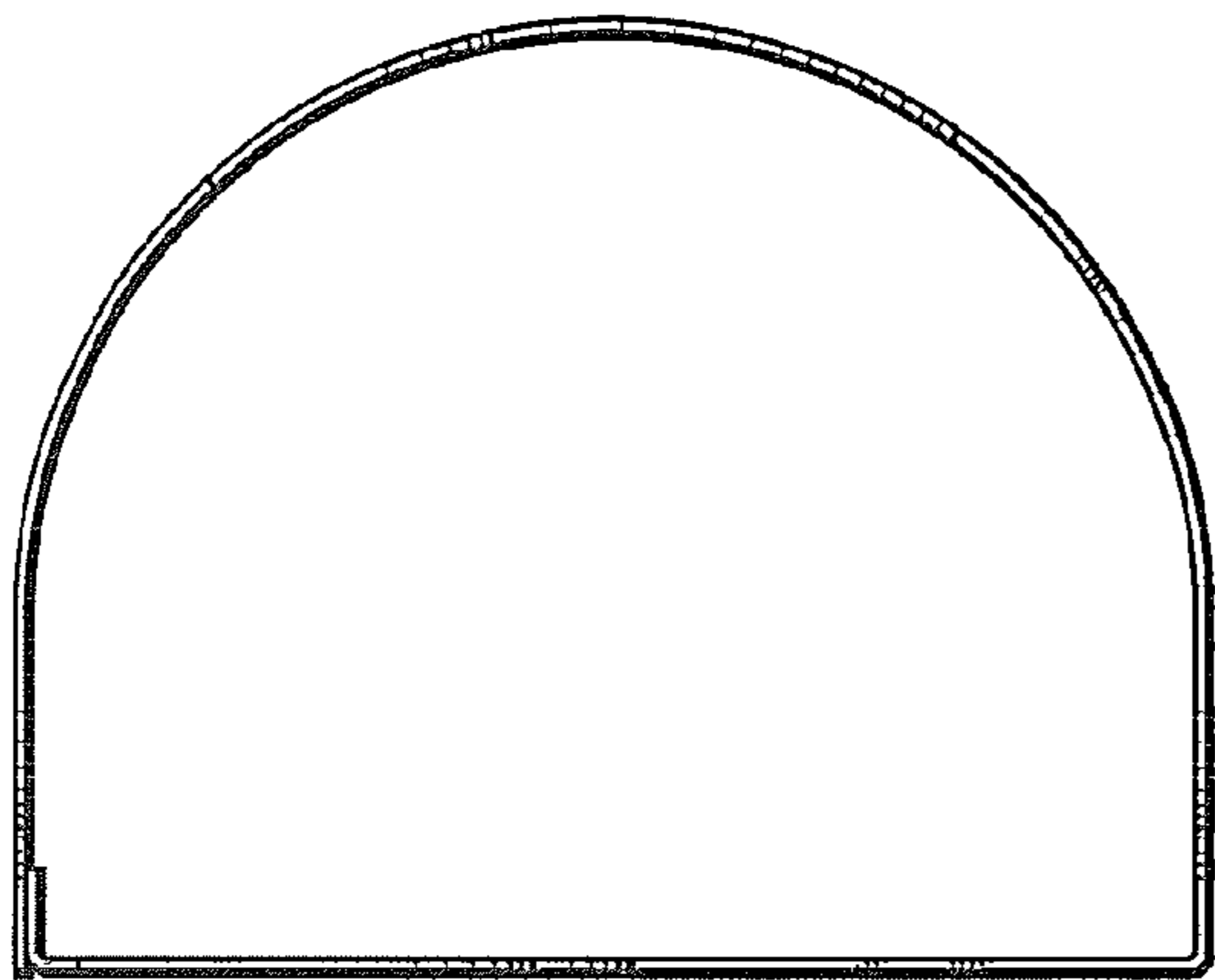

FIG. 6

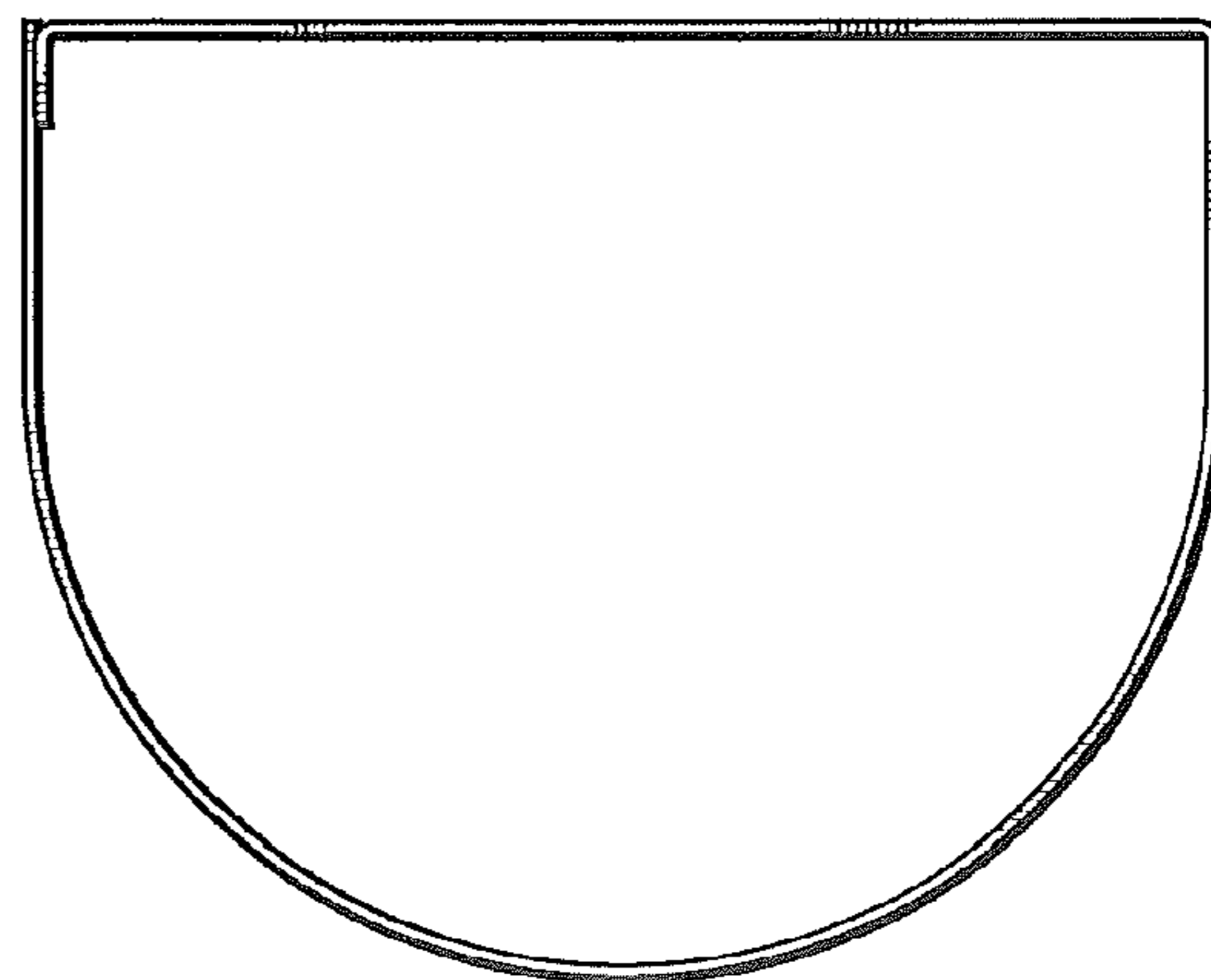

FIG. 7

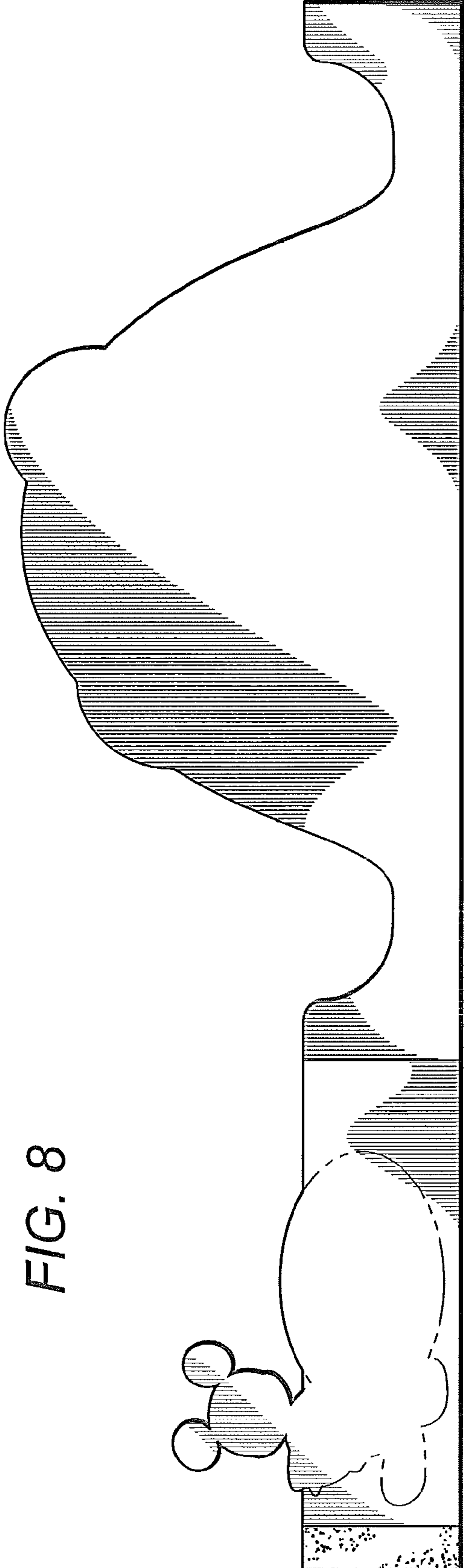

FIG. 8