



US00D715306S

(12) **United States Design Patent**
Fujioka

(10) **Patent No.:** **US D715,306 S**

(45) **Date of Patent:** **** Oct. 14, 2014**

(54) **PAPER STAND**

(71) Applicant: **Robb Fujioka**, Manhattan Beach, CA
(US)

(72) Inventor: **Robb Fujioka**, Manhattan Beach, CA
(US)

(**) Term: **14 Years**

(21) Appl. No.: **29/484,715**

(22) Filed: **Mar. 12, 2014**

(51) **LOC (10) Cl.** **08-03**

(52) **U.S. Cl.**
USPC **D14/447**

(58) **Field of Classification Search**
USPC D14/447, 432, 433, 434, 439, 440, 451,
D14/452, 457, 459, 460, 461, 251, 253, 448,
D14/449, 450; D9/433, 455, 457; D20/10,
D20/25; D6/672, 674, 674.1, 678, 682,
D6/682.3; 40/124.05, 124.06, 124.07,
40/124.08, 124.09, 124.14, 124.16, 539;
248/917-924, 445, 447.1, 451, 456,
248/459, 460, 150, 152, 174, 188.6, 176.1;
361/679.02, 679.09, 679.21, 679.26,
361/679.3, 679.27, 679.55, 679.56

See application file for complete search history.

(56) **References Cited**

U.S. PATENT DOCUMENTS

D123,125 S * 10/1940 Holstein D9/415
5,564,208 A * 10/1996 Bergman 40/539

5,611,161 A * 3/1997 Murphy 40/124.08
5,887,366 A * 3/1999 Volkert et al. 40/124.08
5,983,538 A * 11/1999 Crowell 40/124.14
D469,440 S * 1/2003 Lin D14/447
D661,310 S * 6/2012 Belongia et al. D14/447
D669,085 S * 10/2012 Coberly D14/447
D674,396 S * 1/2013 Yang et al. D14/447
D684,963 S * 6/2013 Goodrich D14/253
2011/0278421 A1 * 11/2011 Guldalian 248/459
2012/0181410 A1 * 7/2012 Ku et al. 248/453
2012/0318950 A1 * 12/2012 Wilber 248/459

* cited by examiner

Primary Examiner — Angela J Lee

(74) *Attorney, Agent, or Firm* — Steptoe & Johnson LLP

(57) **CLAIM**

The ornamental design for a paper stand, as shown and described.

DESCRIPTION

FIG. 1 is a top, front, right side, perspective view of my design;
FIG. 2 is front elevation view;
FIG. 3 is a rear elevation view;
FIG. 4 is a left side elevation view;
FIG. 5 is a right side elevation view;
FIG. 6 is a top plan view;
FIG. 7 is a bottom plan view; and,
FIG. 8 is a view of the paper stand in a flat, unfolded position.
The broken lines shown in the drawings represent a tablet that forms no part of the claimed design.

1 Claim, 3 Drawing Sheets

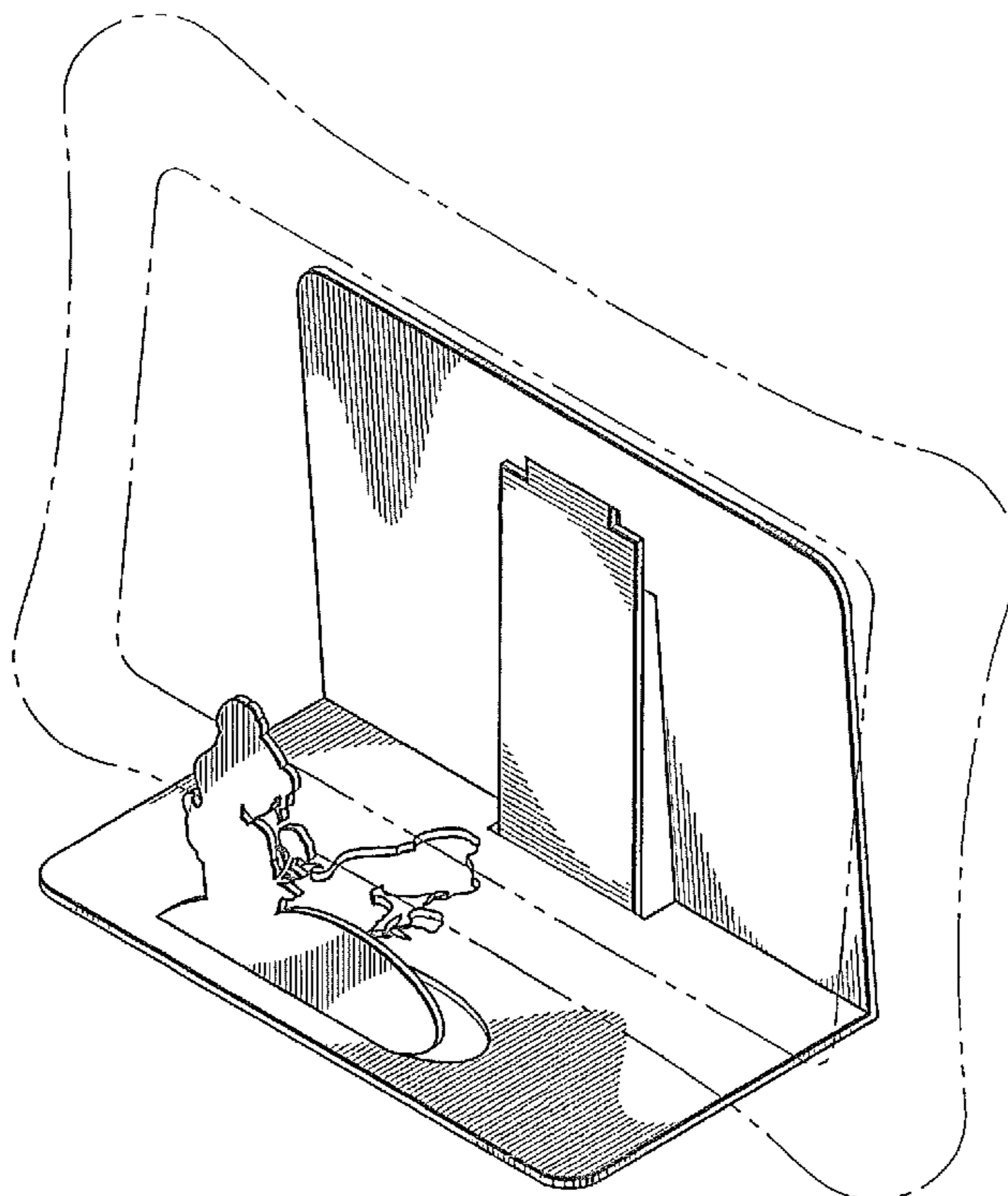

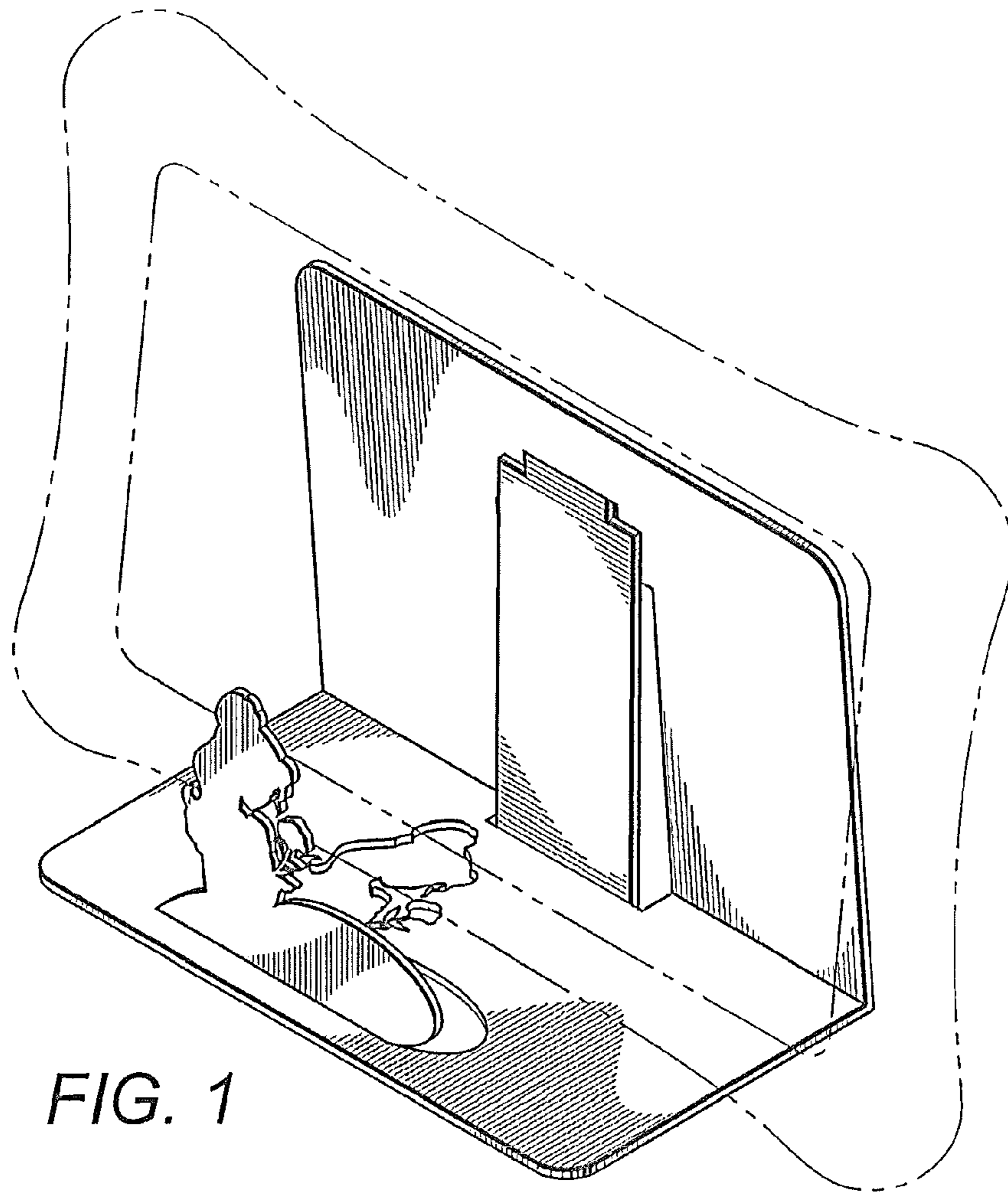
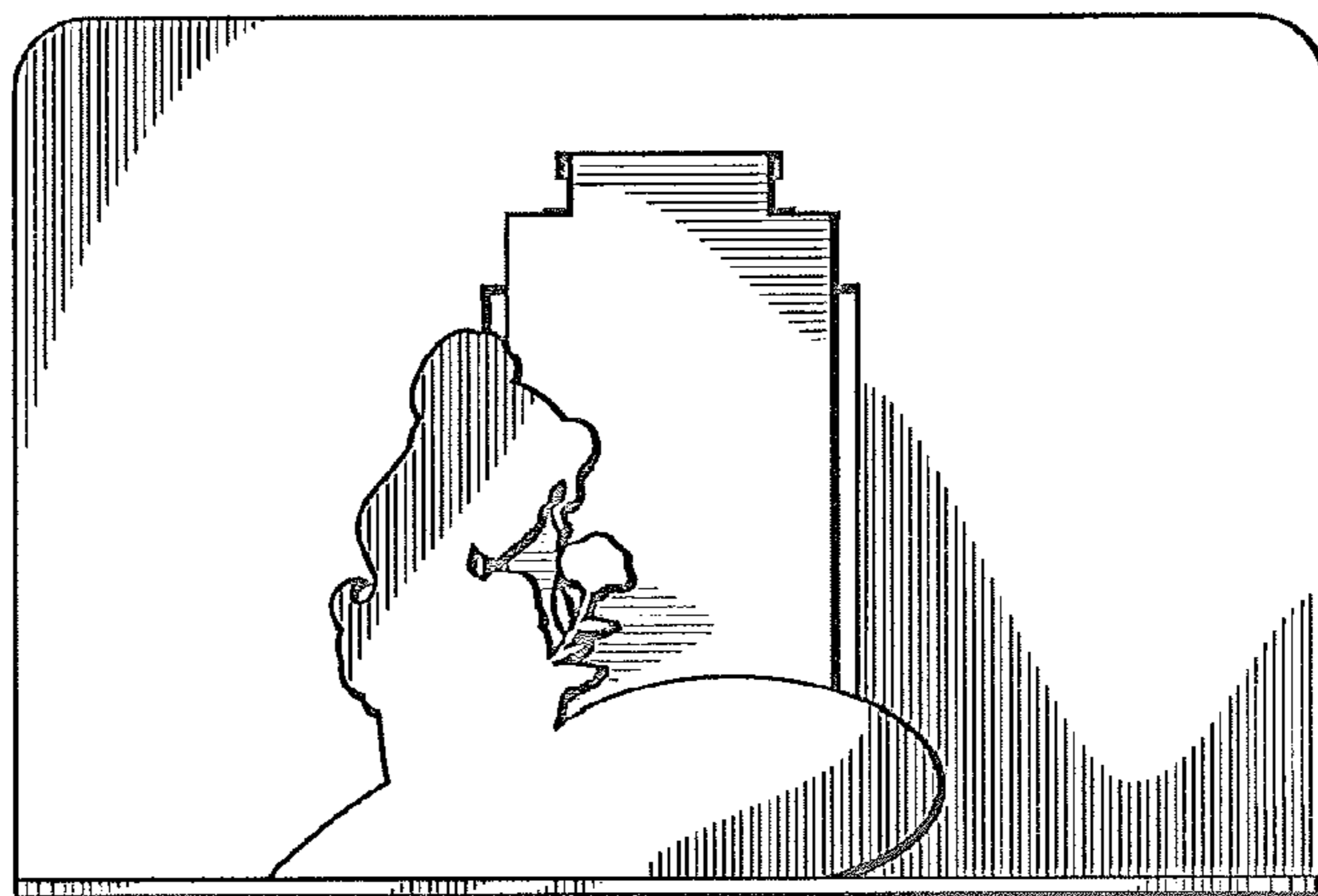

FIG. 1

FIG. 2



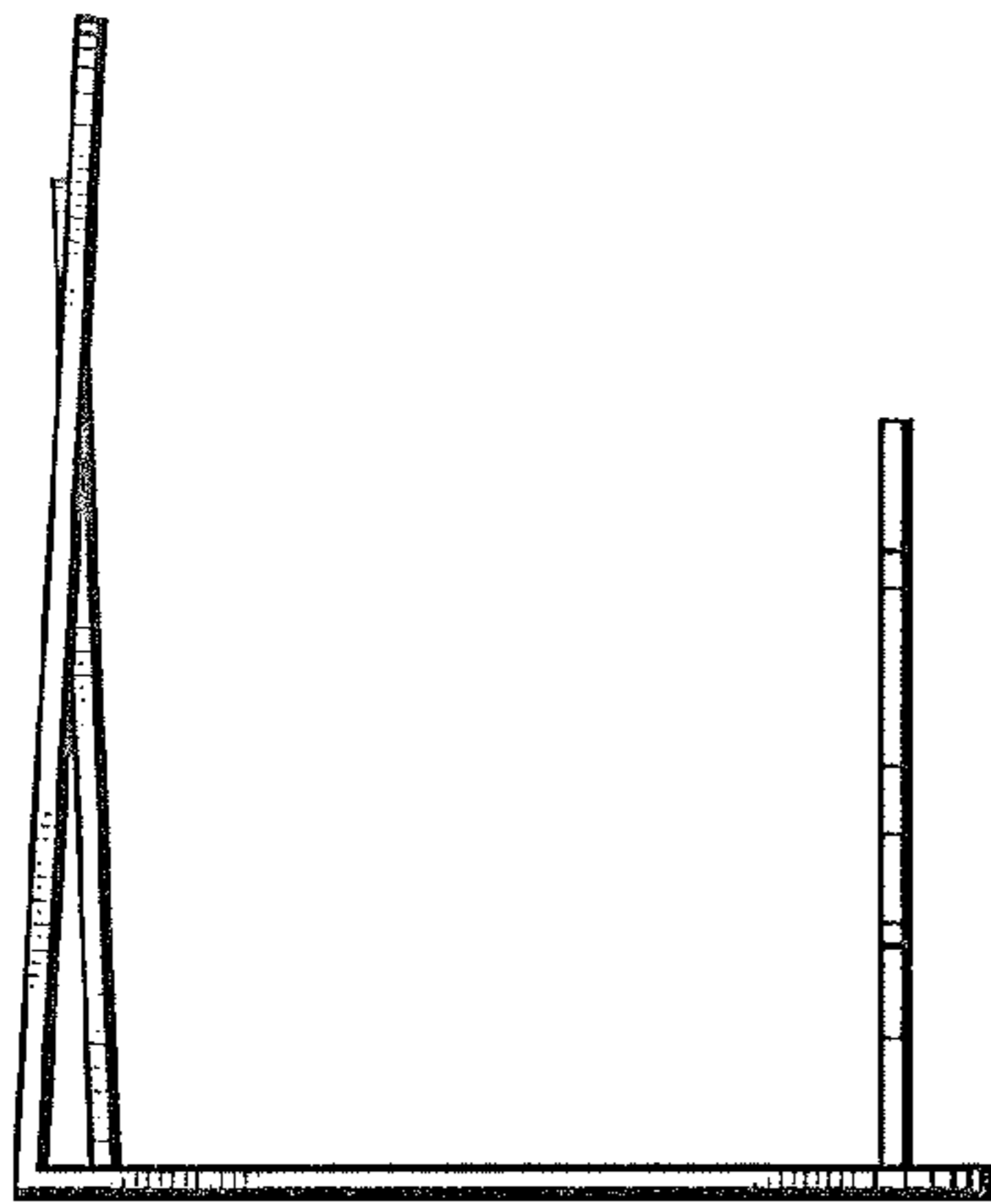

FIG. 4

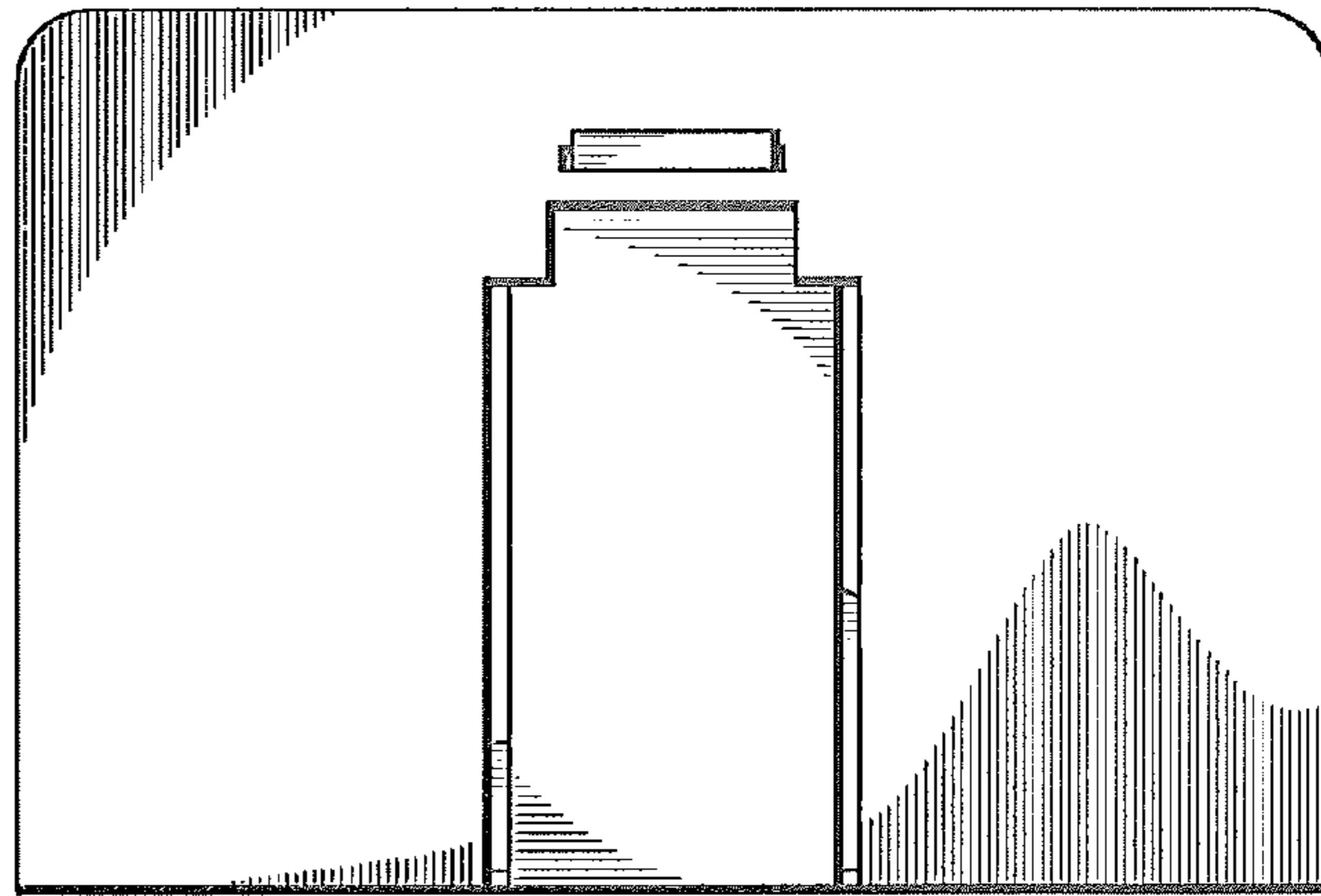

FIG. 3

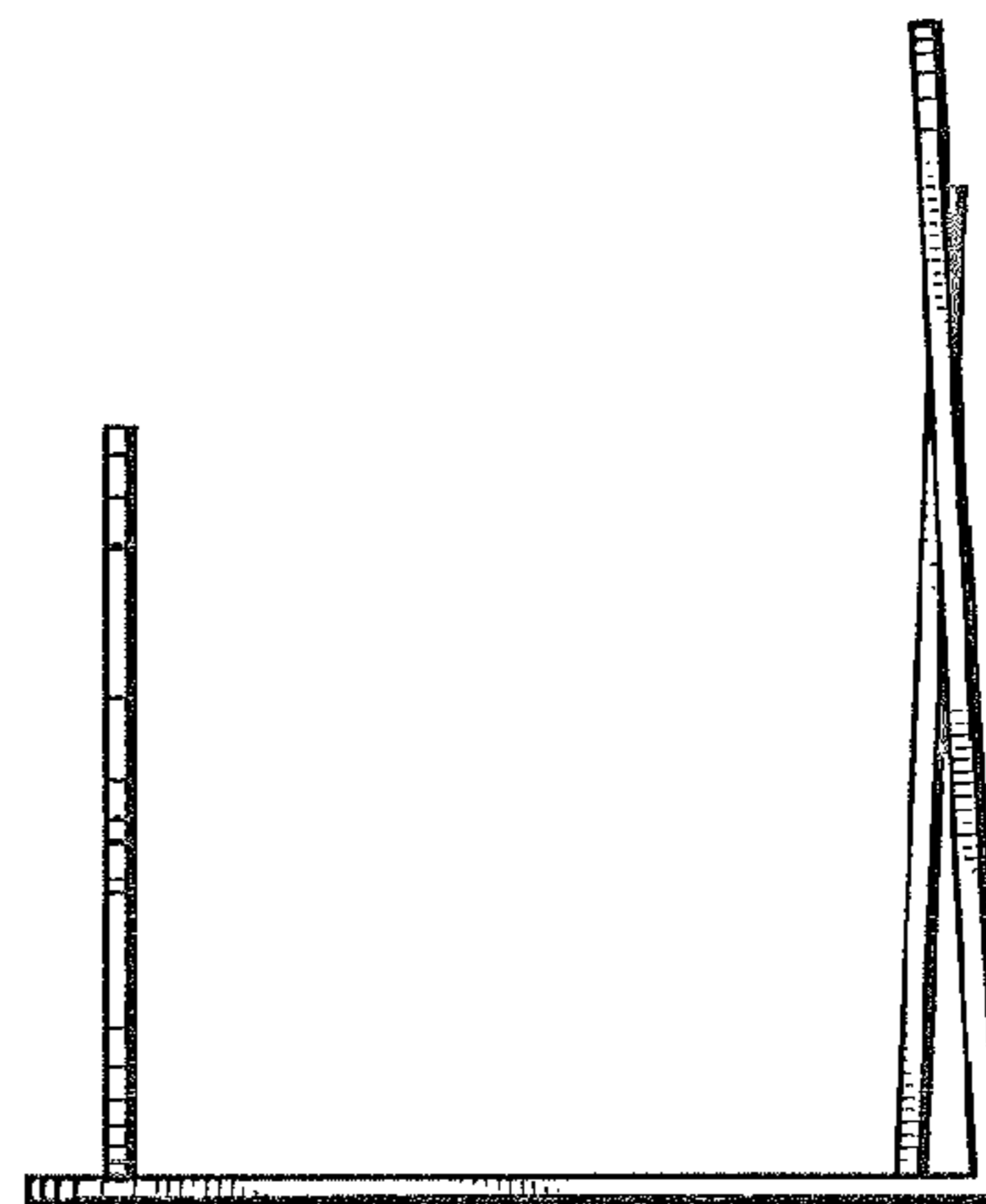
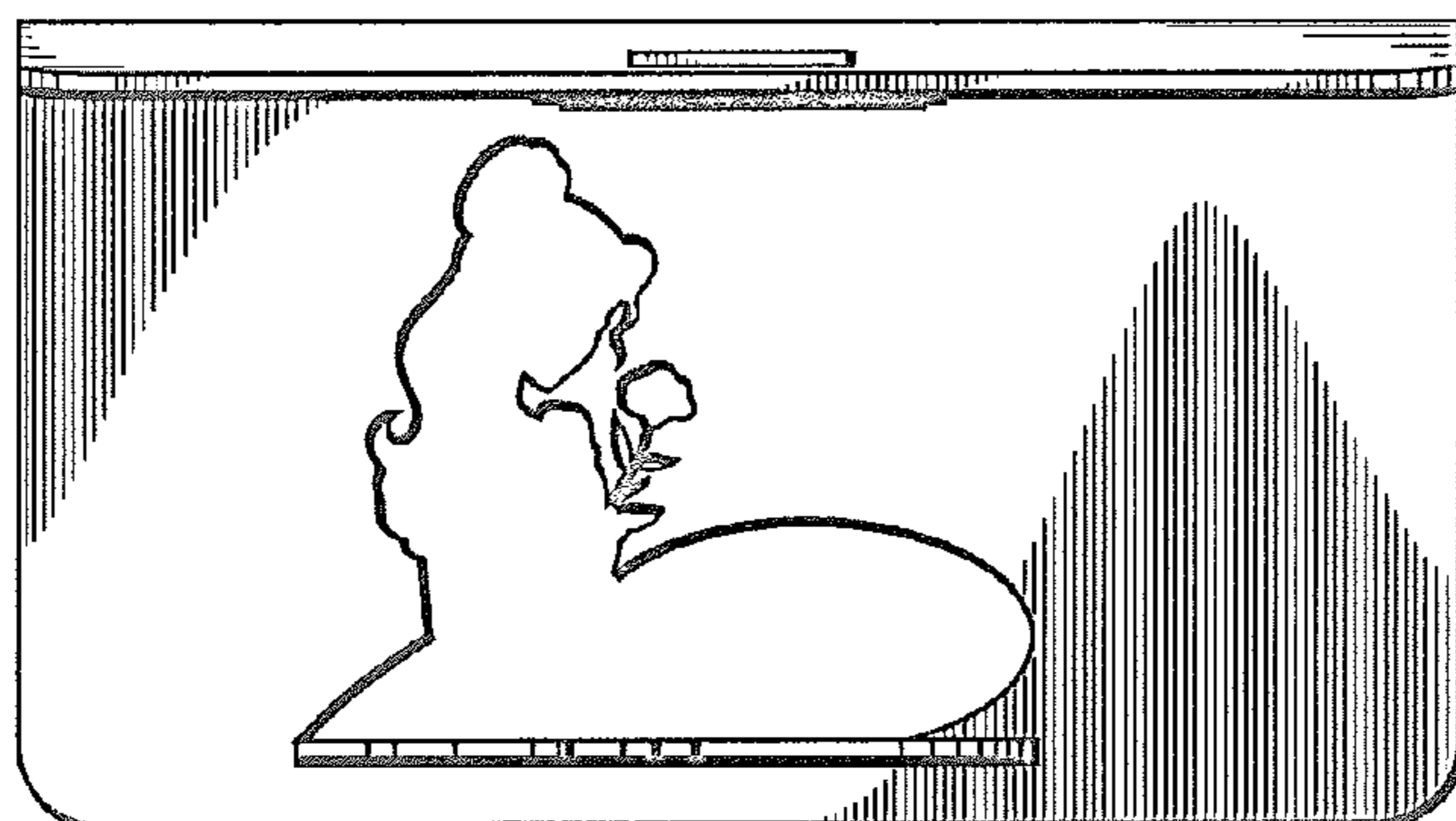

FIG. 5

FIG. 6



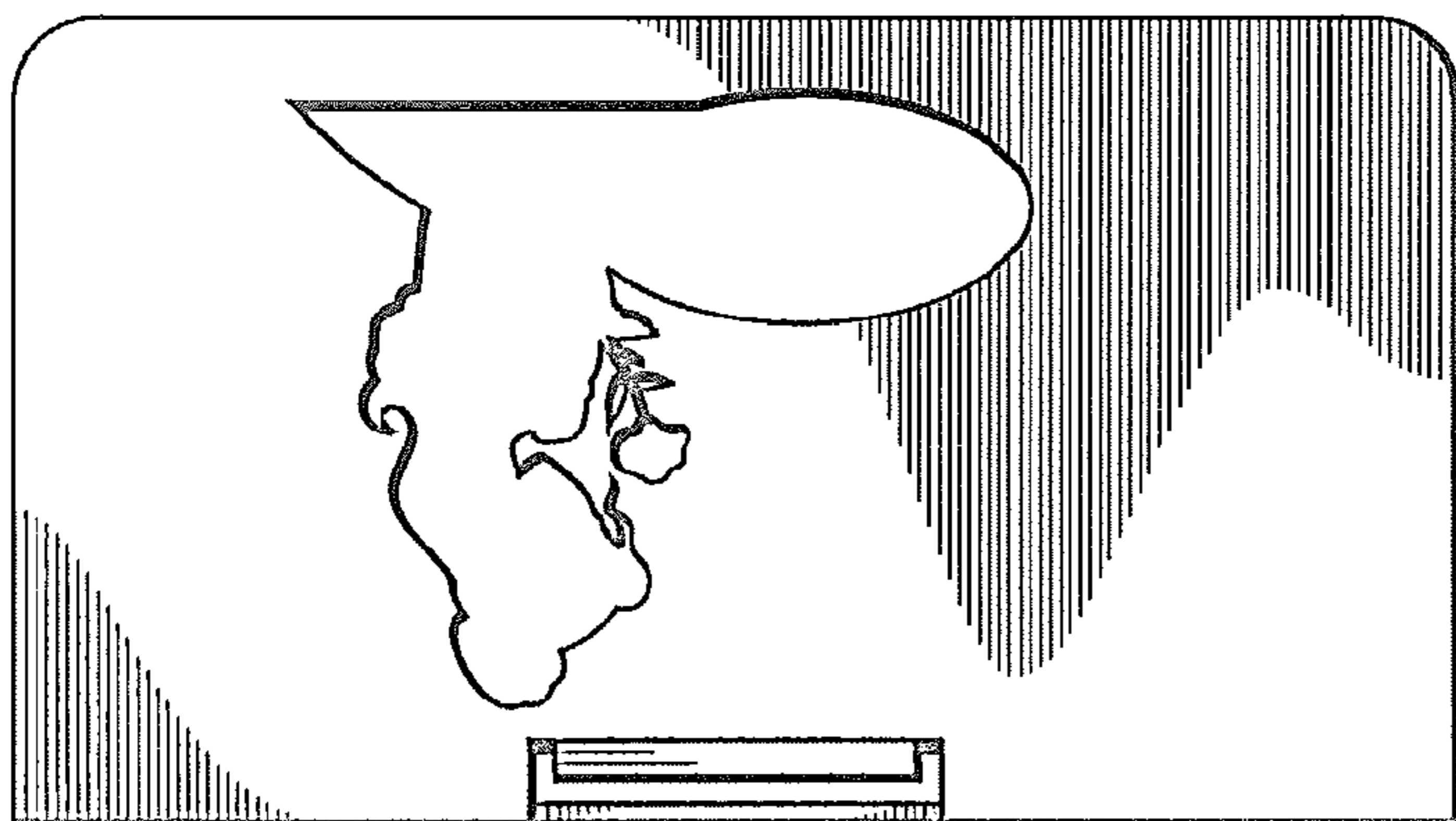

FIG. 7

FIG. 8

