



US00D715288S

(12) **United States Design Patent**  
**Nagao et al.**

(10) **Patent No.:** **US D715,288 S**  
(45) **Date of Patent:** **\*\* Oct. 14, 2014**

(54) **PERSONAL COMPUTER**

(71) Applicant: **Fujitsu Limited**, Kawasaki (JP)

(72) Inventors: **Eiji Nagao**, Ichikawa (JP); **Hiroyuki Fujita**, Tokyo (JP); **Mark Friesen**, Tokyo (JP); **Nobuharu Tsusaka**, Kawasaki (JP); **Hisao Morooka**, Kawasaki (JP); **Toni Koberling**, München (DE)

(73) Assignee: **Fujitsu Limited**, Kawasaki (JP)

(\*\*) Term: **14 Years**

(21) Appl. No.: **29/453,946**

(22) Filed: **May 3, 2013**

(30) **Foreign Application Priority Data**

Nov. 6, 2012 (JP) ..... 2012-026974

(51) **LOC (10) Cl.** ..... **14-02**

(52) **U.S. Cl.**  
USPC ..... **D14/318**

(58) **Field of Classification Search**

USPC ..... D14/315-327, 439; D18/1, 2, 7, 11;  
235/145 A, 145 R; 341/22, 23; 345/104,  
345/156, 168, 169, 173; 361/679.08,  
361/679.09, 679.11, 679.26, 679.27;  
16/367

See application file for complete search history.

(56) **References Cited**

**U.S. PATENT DOCUMENTS**

D504,683 S \* 5/2005 Kim et al. .... D14/315  
D506,752 S \* 6/2005 Huh ..... D14/316  
D516,552 S \* 3/2006 Iseki ..... D14/318  
D558,753 S \* 1/2008 Andre et al. .... D14/315

2005/0041378 A1\* 2/2005 Hamada et al. .... 361/680

\* cited by examiner

*Primary Examiner* — Freda S Nunn

(74) *Attorney, Agent, or Firm* — Staas & Halsey LLP

(57) **CLAIM**

The ornamental design for a personal computer, as shown and described.

**DESCRIPTION**

FIG. 1 is a perspective view of front, bottom and right side of a personal computer showing our new design;

FIG. 2 is a perspective view of rear, bottom and left side thereof;

FIG. 3 is a front view thereof;

FIG. 4 is a rear view thereof;

FIG. 5 is a left side view thereof;

FIG. 6 is a right side view thereof;

FIG. 7 is a top view thereof;

FIG. 8 is a bottom view thereof;

FIG. 9 is a perspective view of front, bottom and right side thereof, with lid open;

FIG. 10 is a perspective view of rear, bottom and left side thereof, with lid open;

FIG. 11 is a front view thereof, with lid open;

FIG. 12 is a rear view thereof, with lid open;

FIG. 13 is a left side view thereof, with lid open;

FIG. 14 is a right side view thereof, with lid open;

FIG. 15 is a top view thereof, with lid open;

FIG. 16 is a bottom view thereof, with lid open;

FIG. 17 is a cross-sectional view taken along line 17-17' in FIG. 15 thereof, omitting the interior mechanism;

FIG. 18 is a cross-sectional view taken along line 18-18' in FIG. 15 thereof, omitting the interior mechanism;

FIG. 19 is a partial enlarged view taken along line 19-19' in FIG. 17 thereof; and,

FIG. 20 is a cross-sectional view taken along line 20-20' in FIG. 15 thereof, omitting the interior mechanism.

**1 Claim, 17 Drawing Sheets**

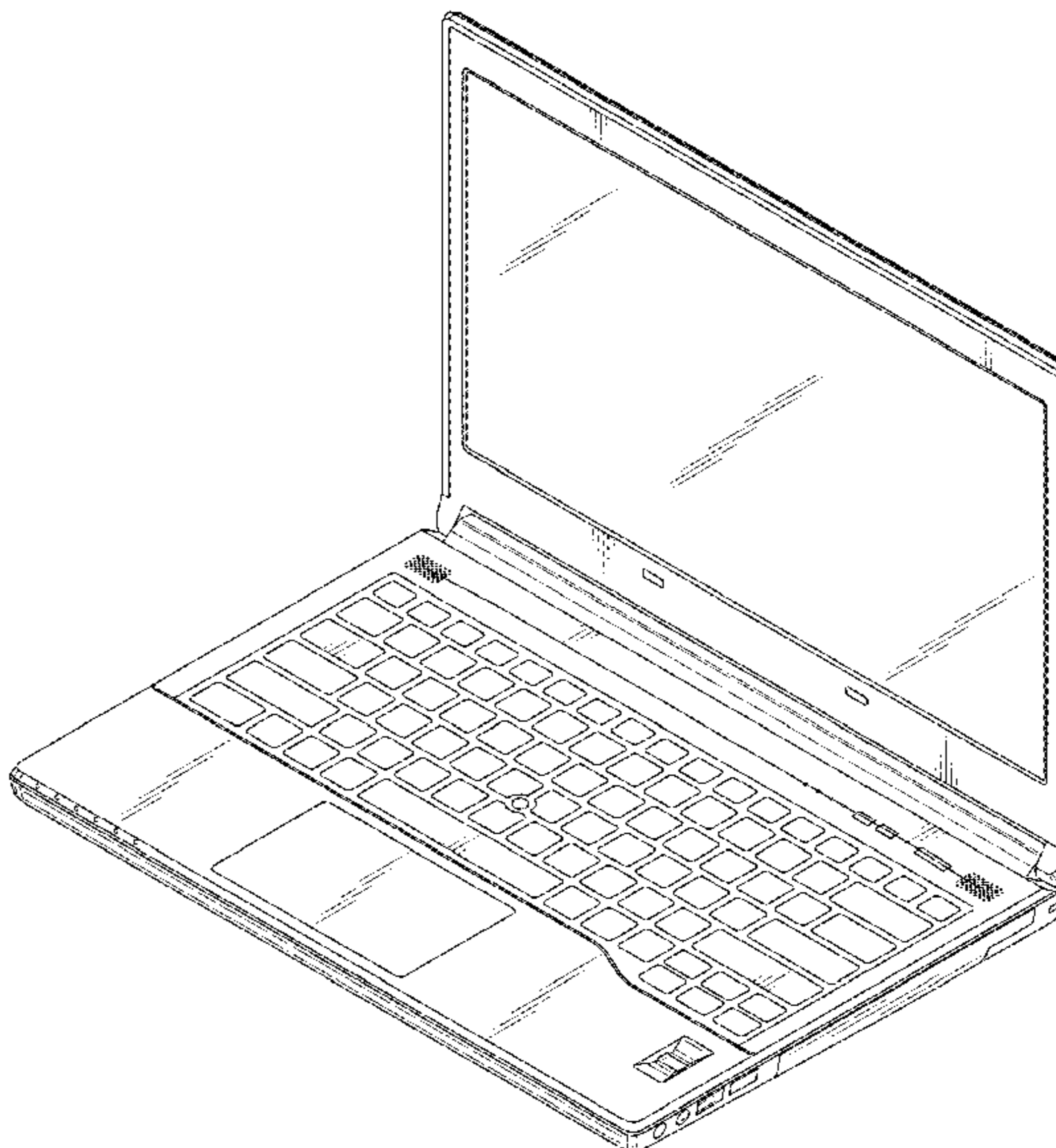
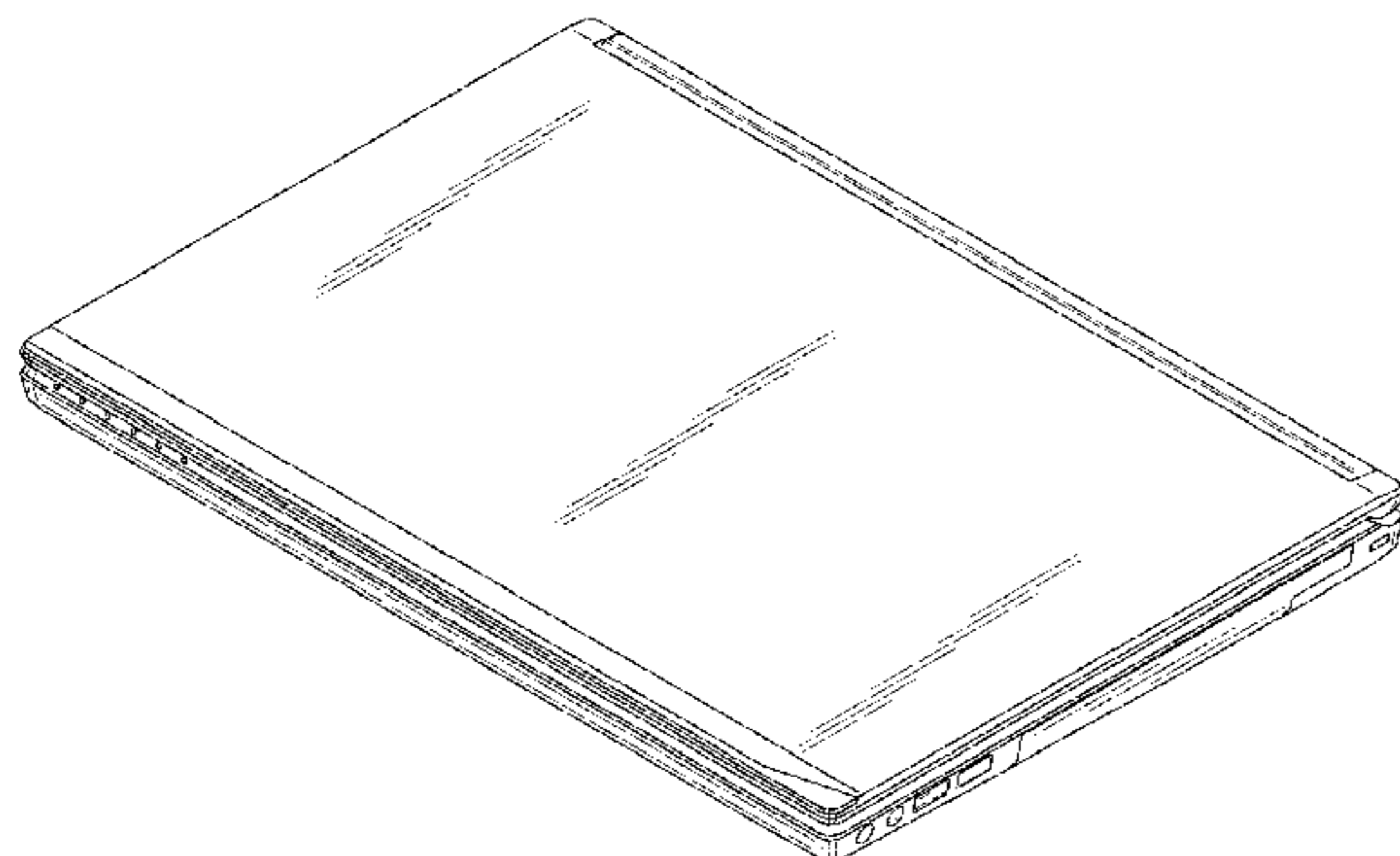

Fig. 1

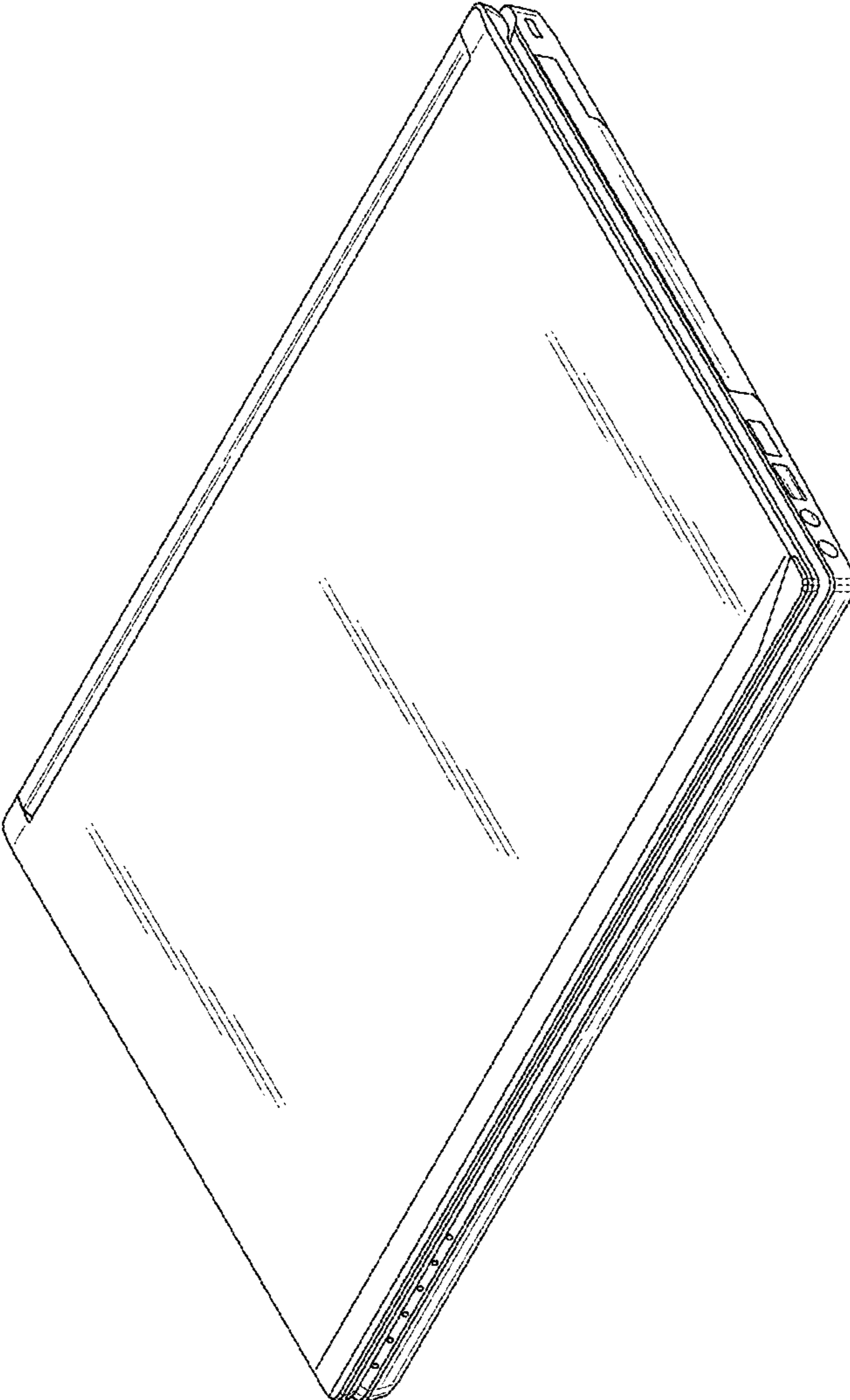

Fig. 2

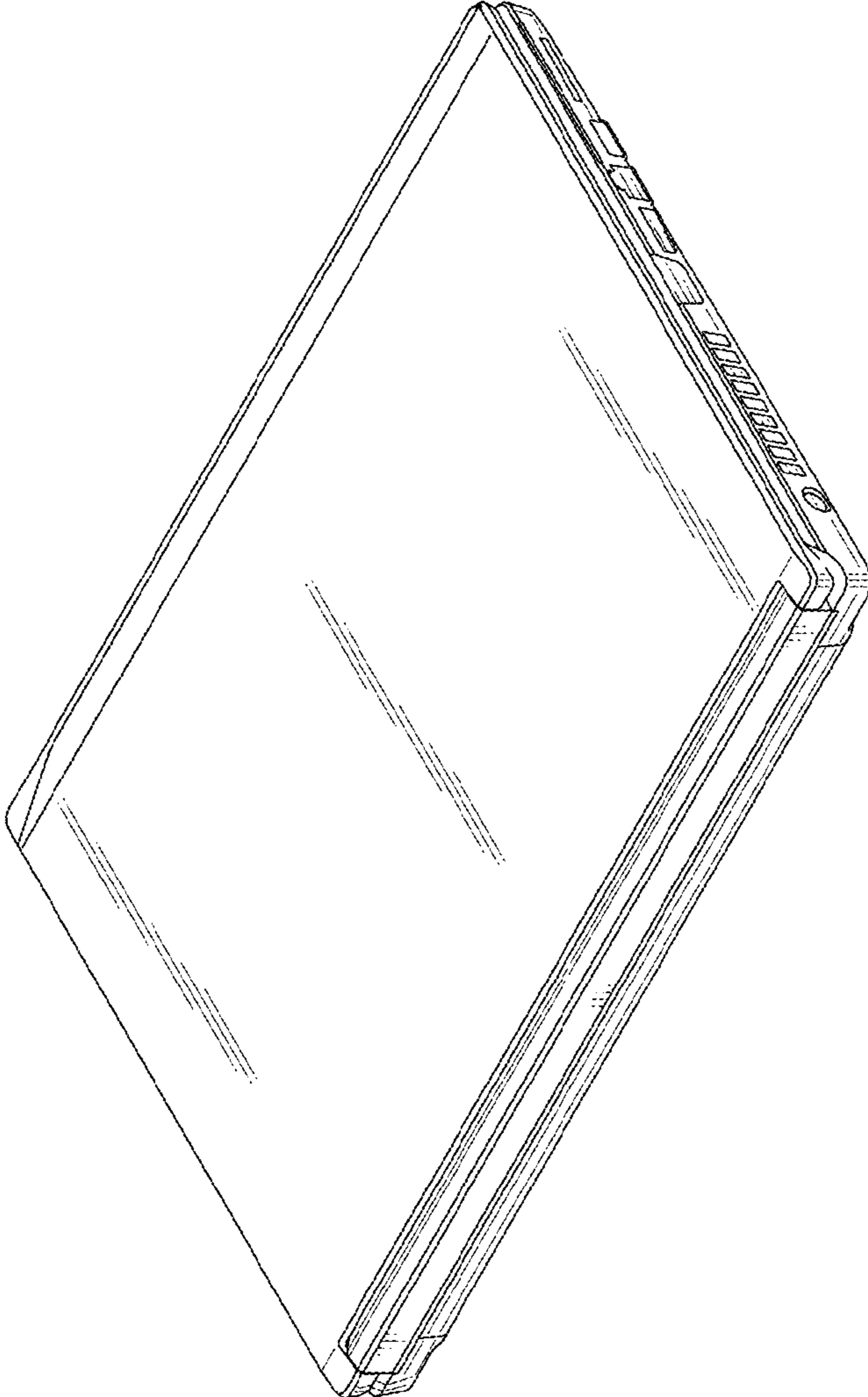

Fig. 3

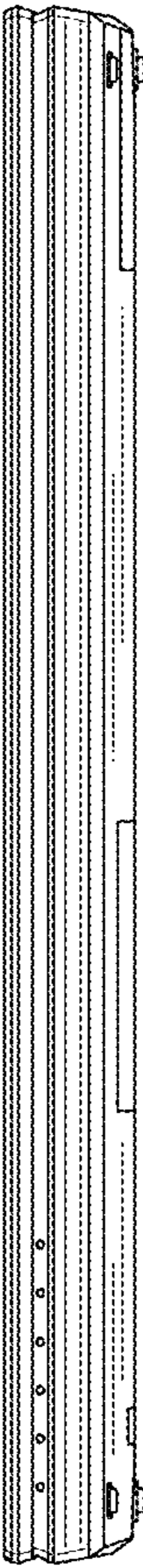

Fig. 4

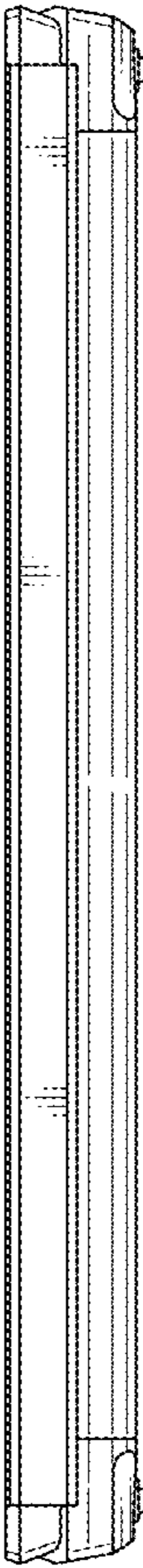

Fig. 5

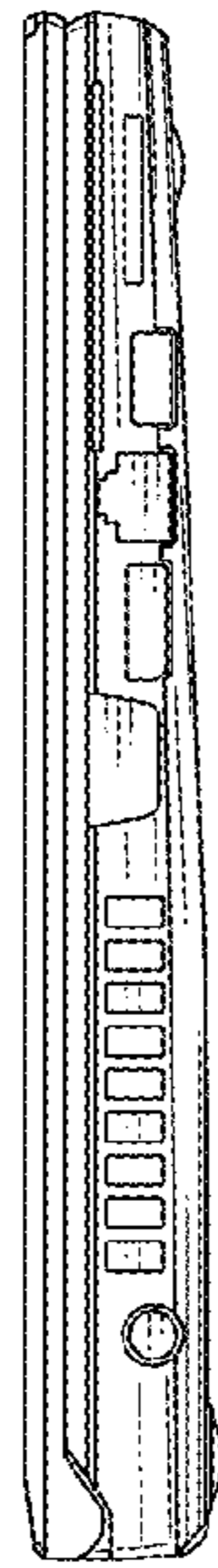

Fig. 6

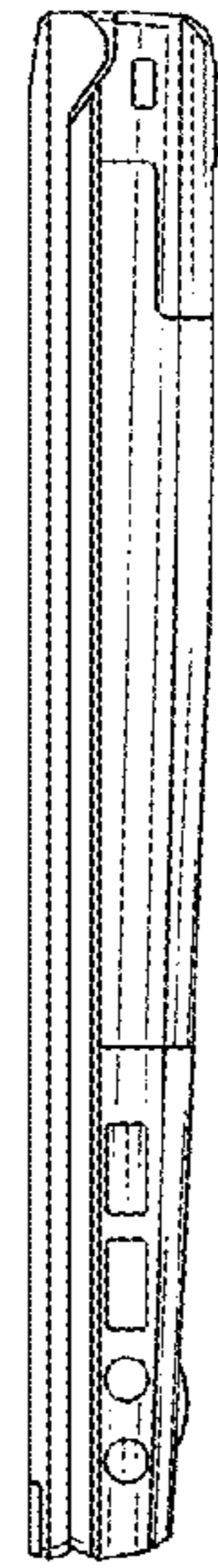

Fig. 7

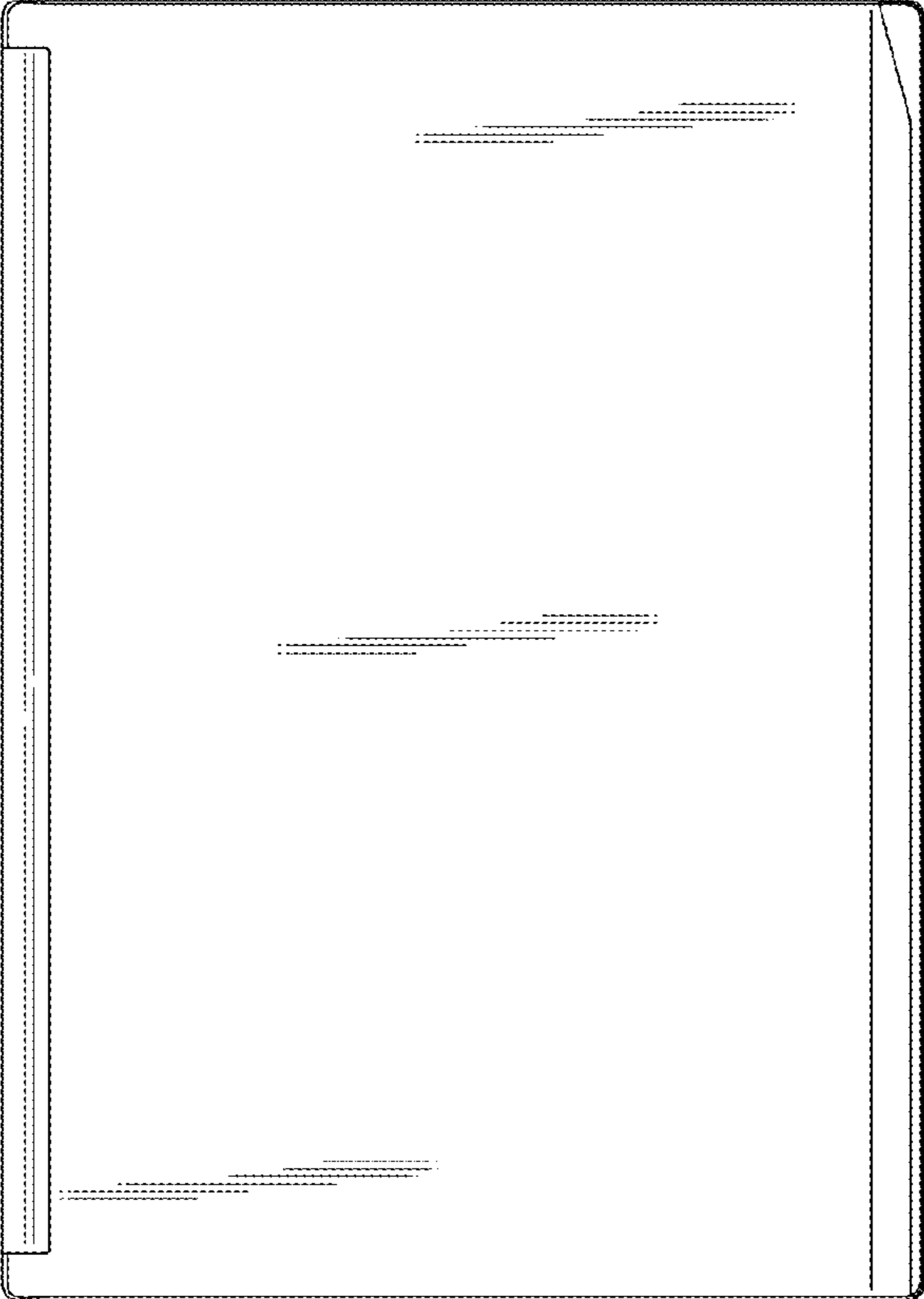
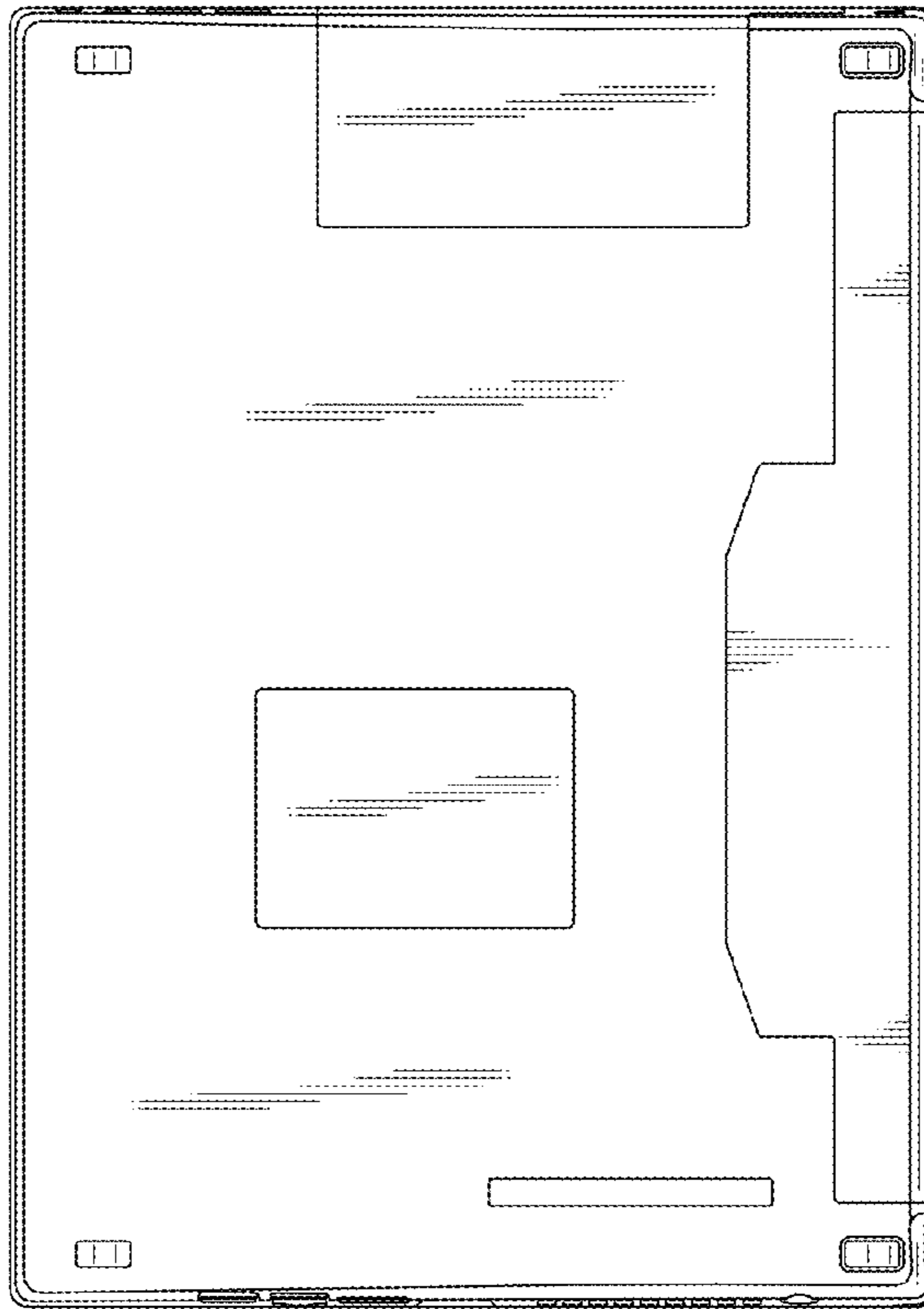

Fig. 8



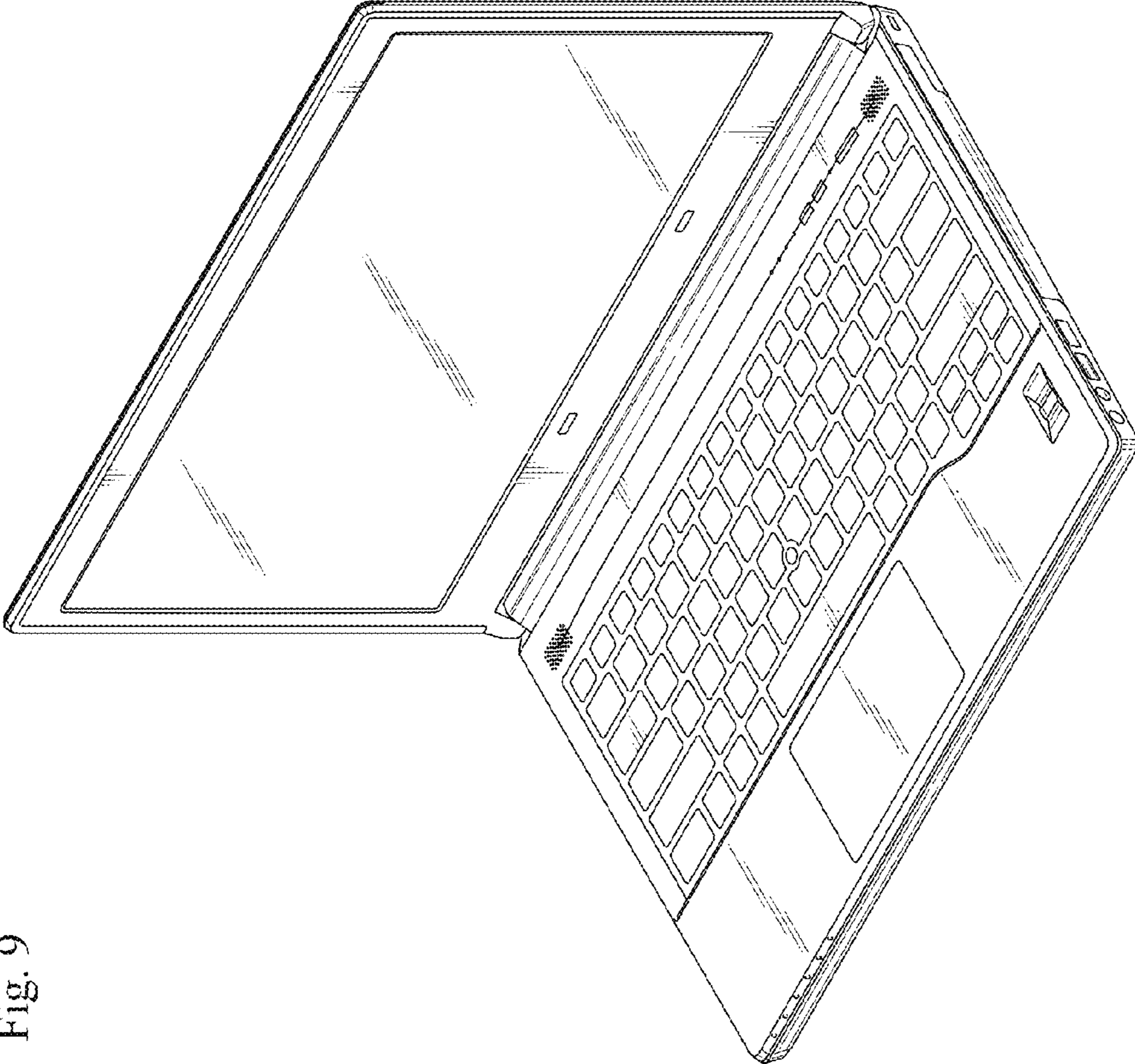

Fig. 9



Fig. 10

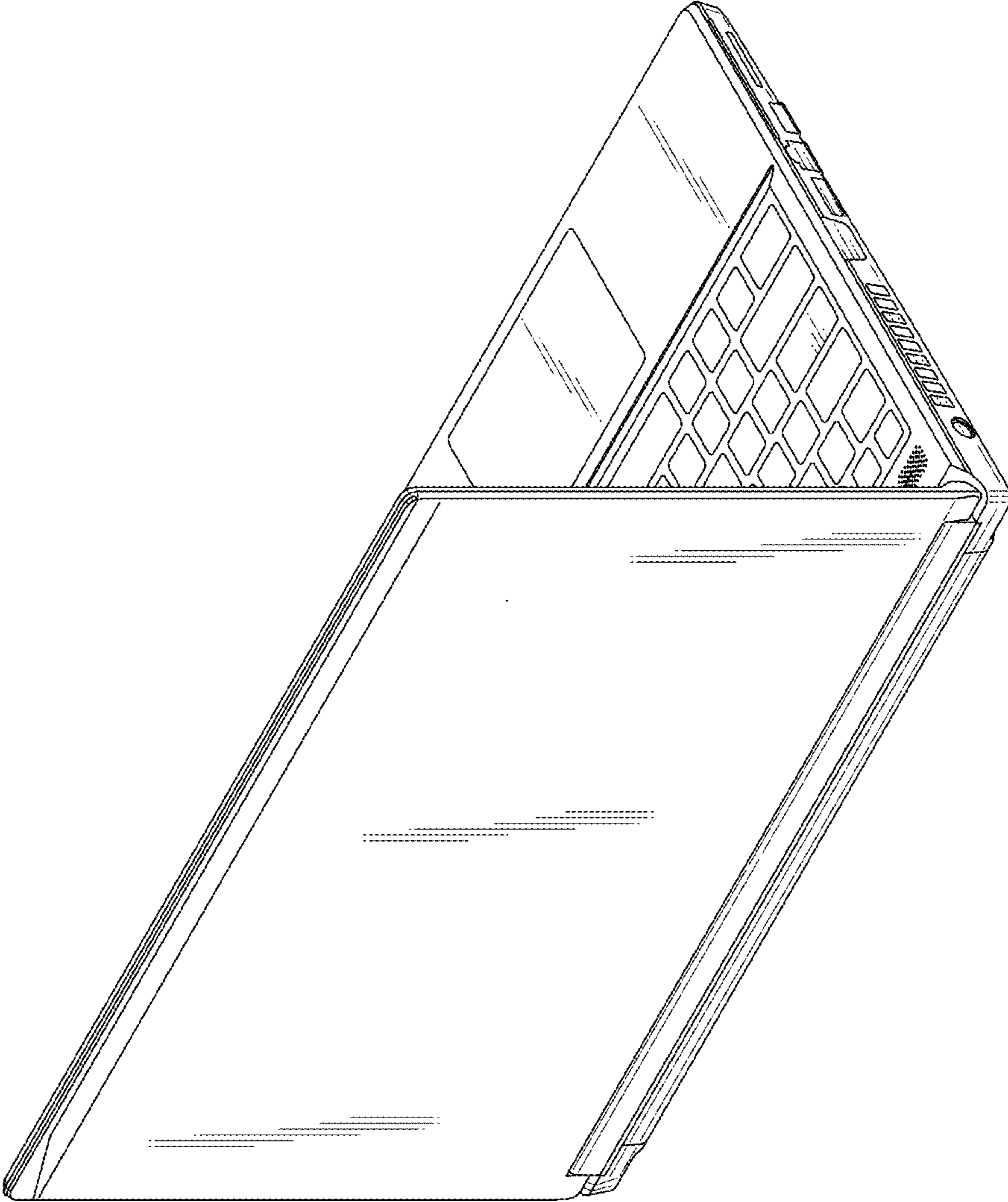

Fig. 11

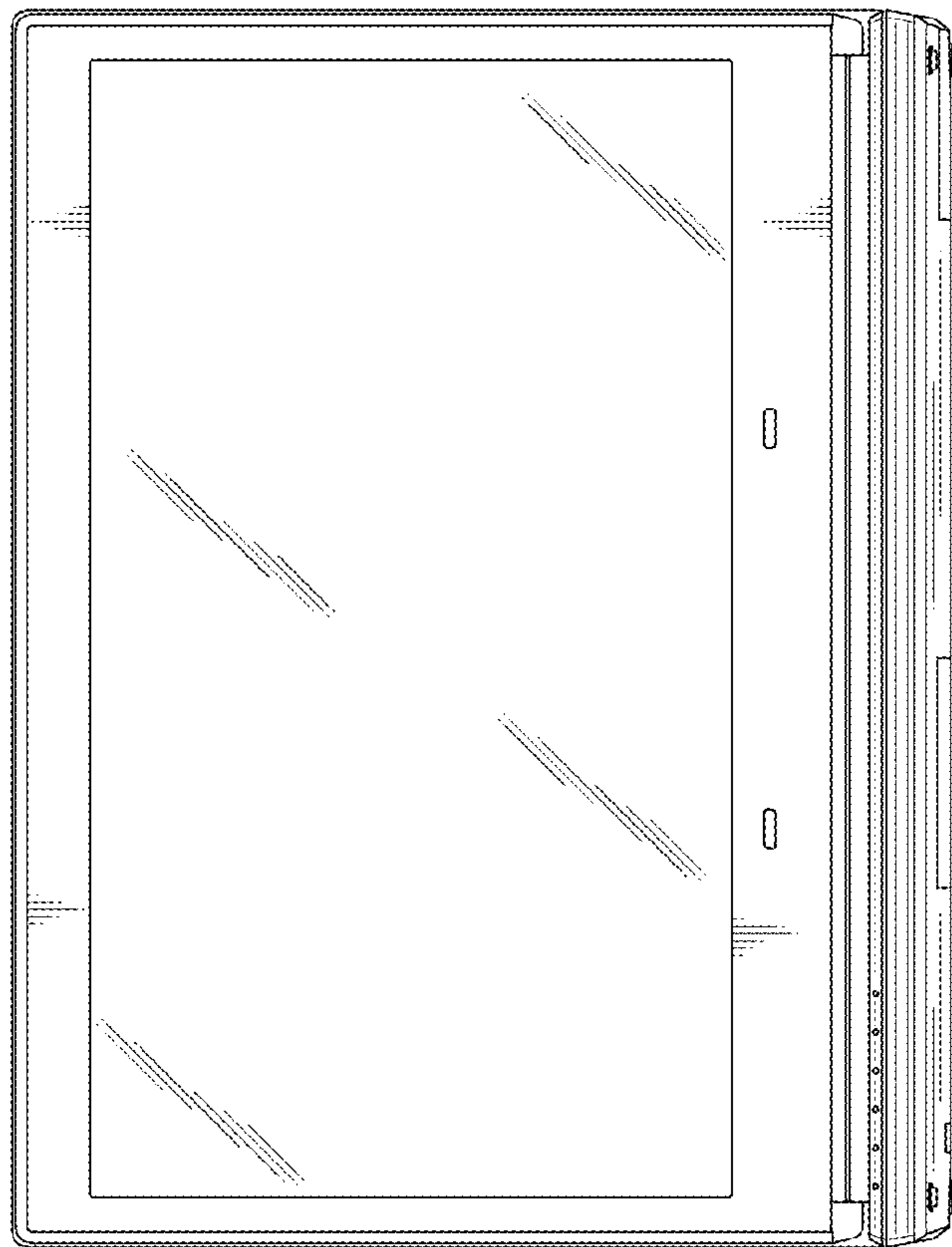

Fig. 12

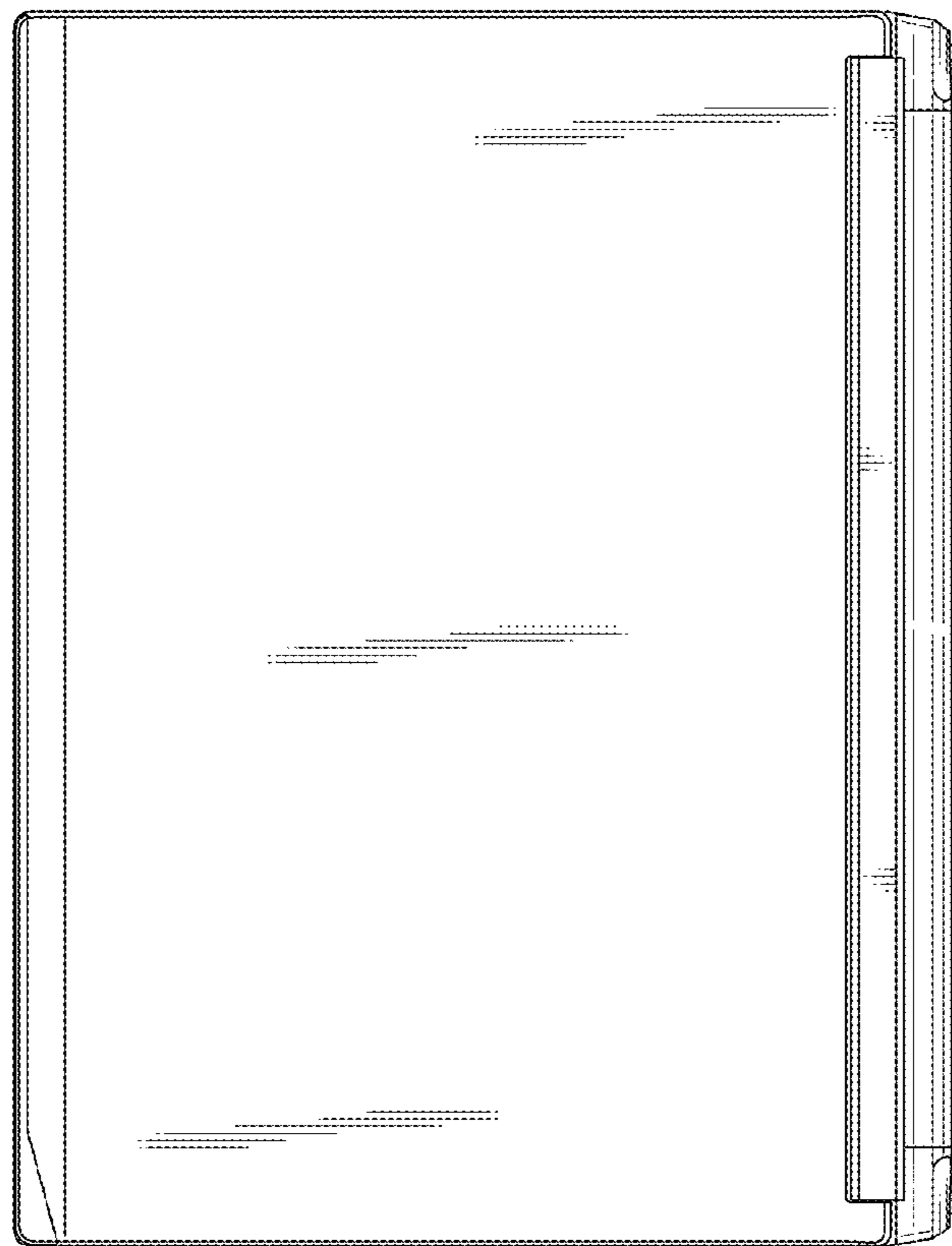

Fig. 14

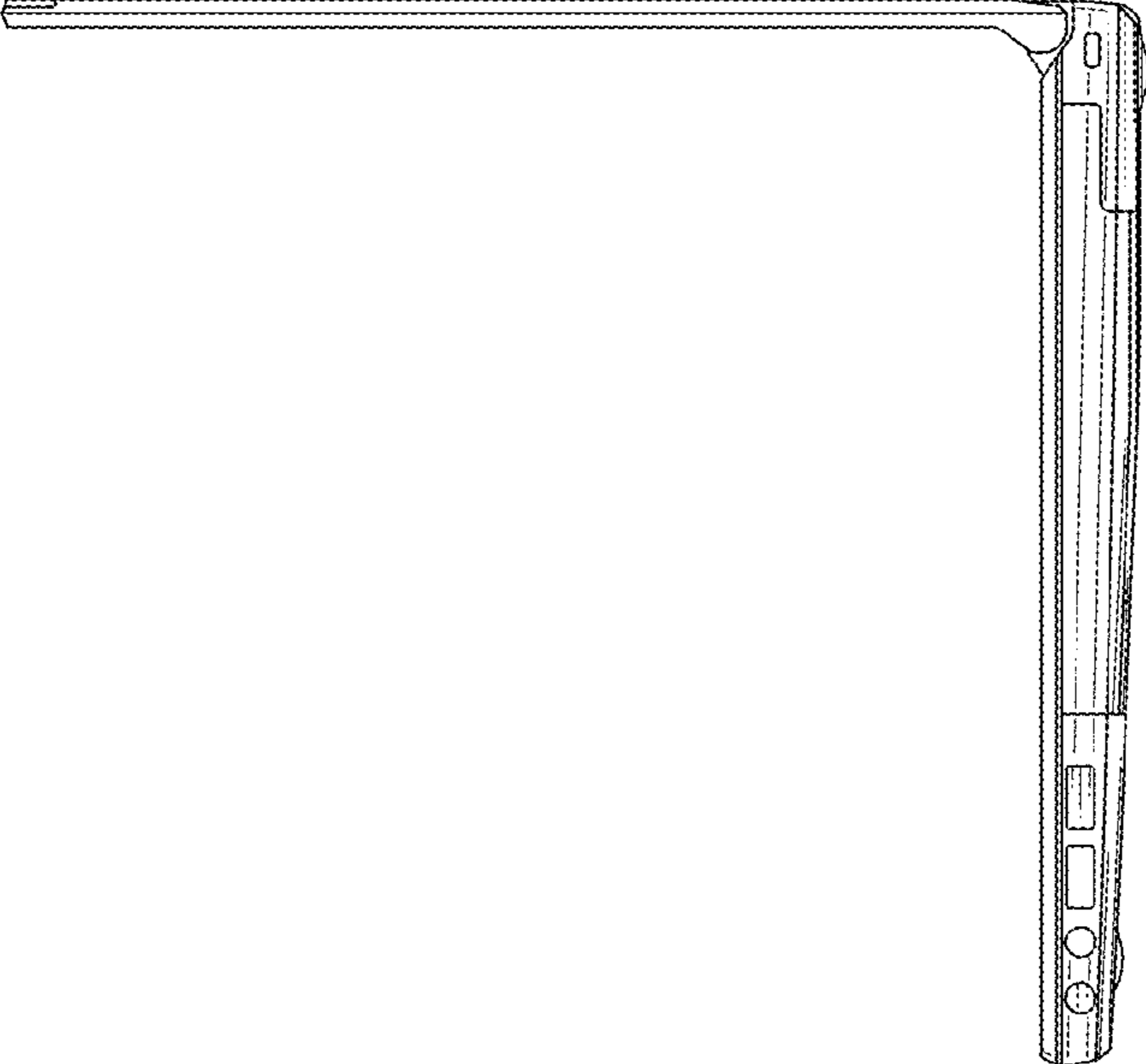

Fig. 13

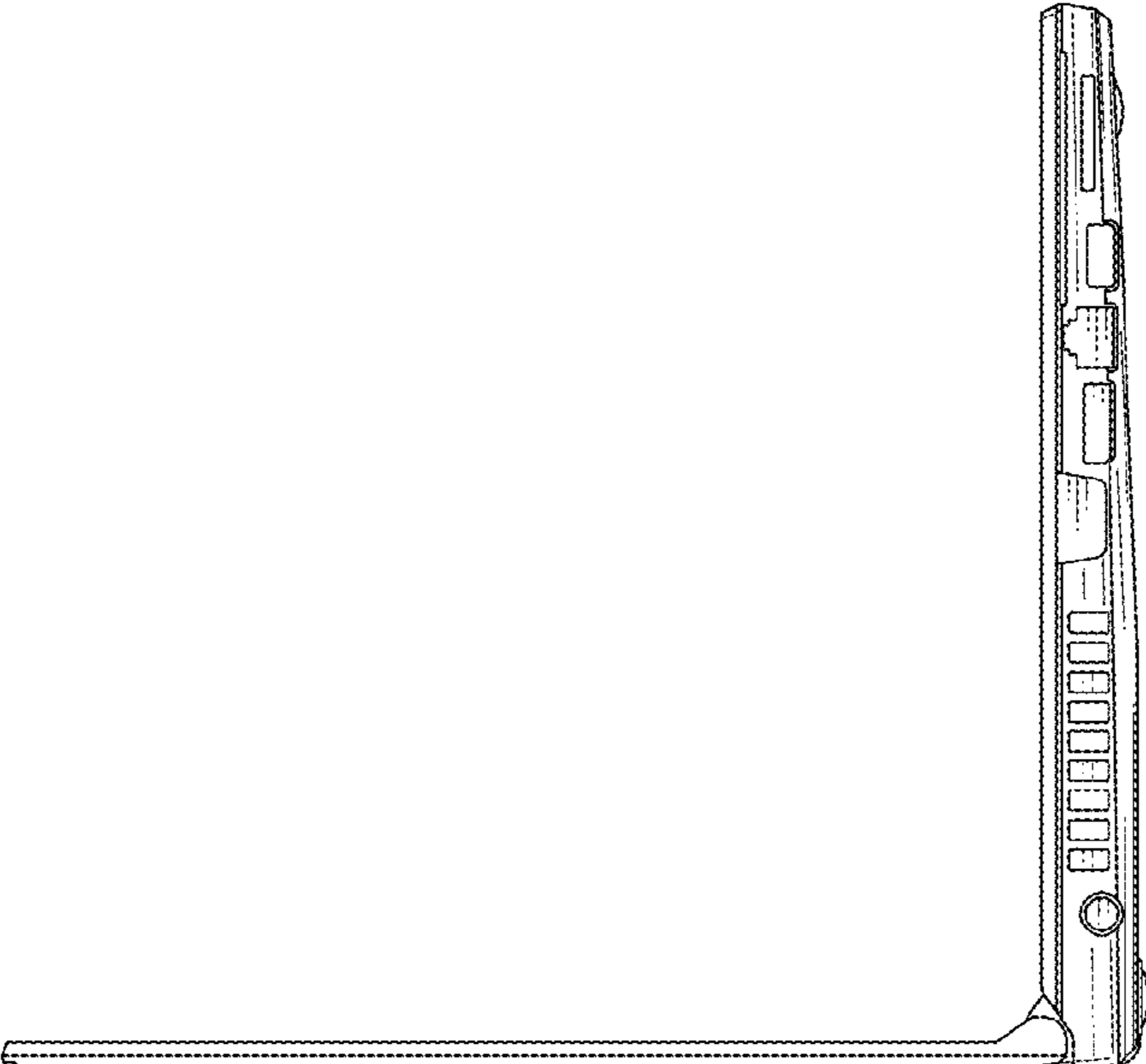

Fig. 15

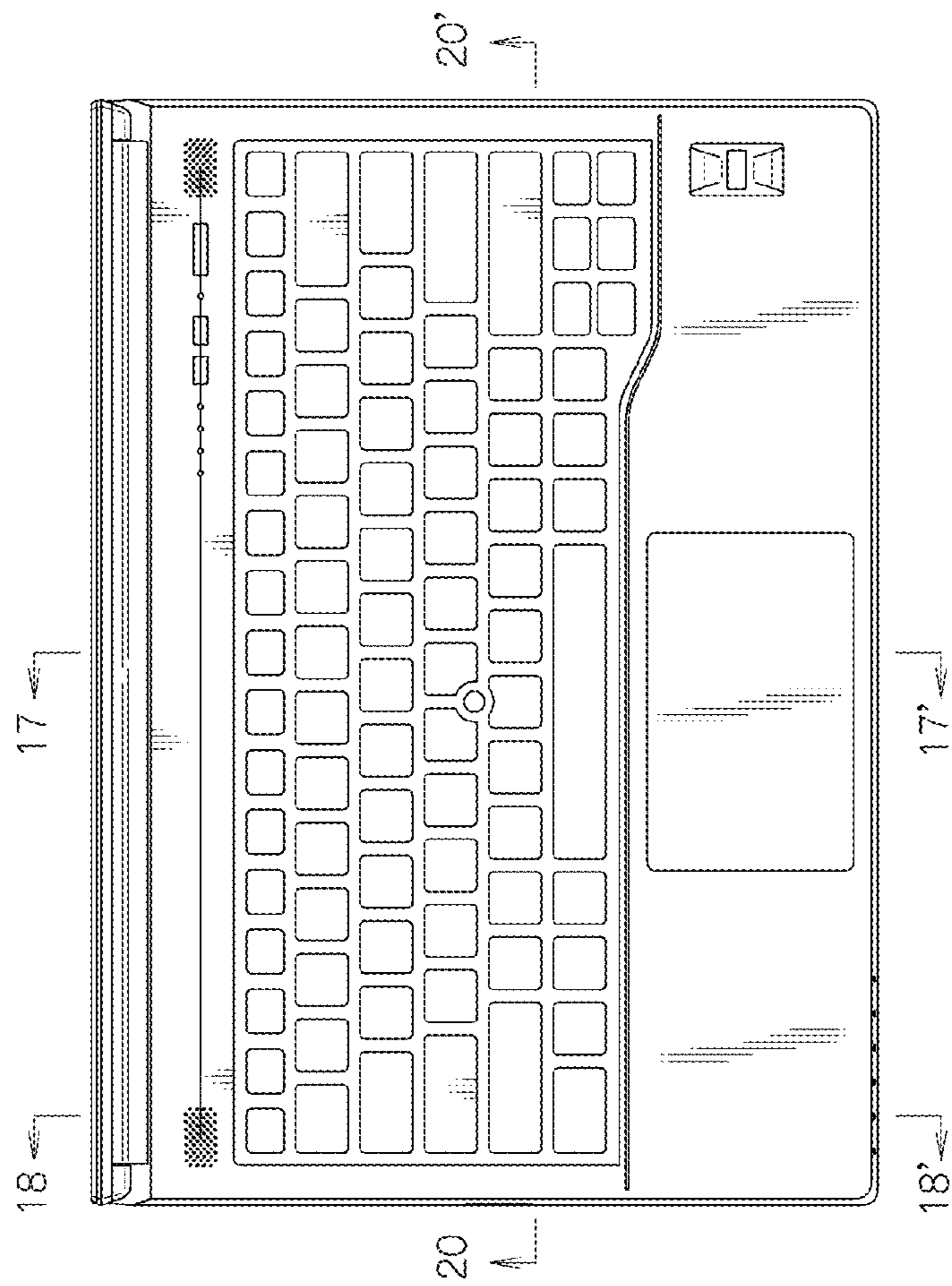

Fig. 16

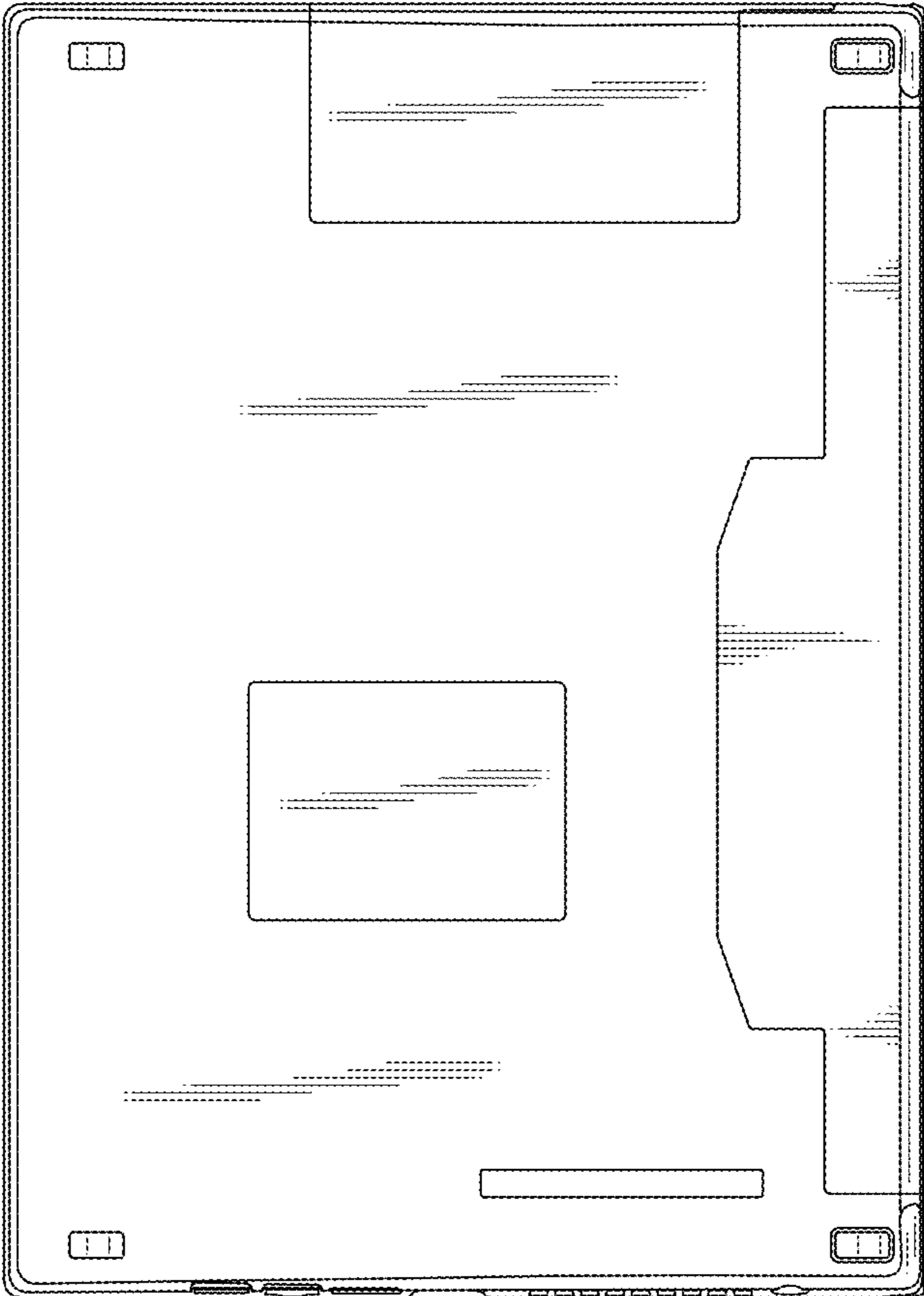

Fig. 17

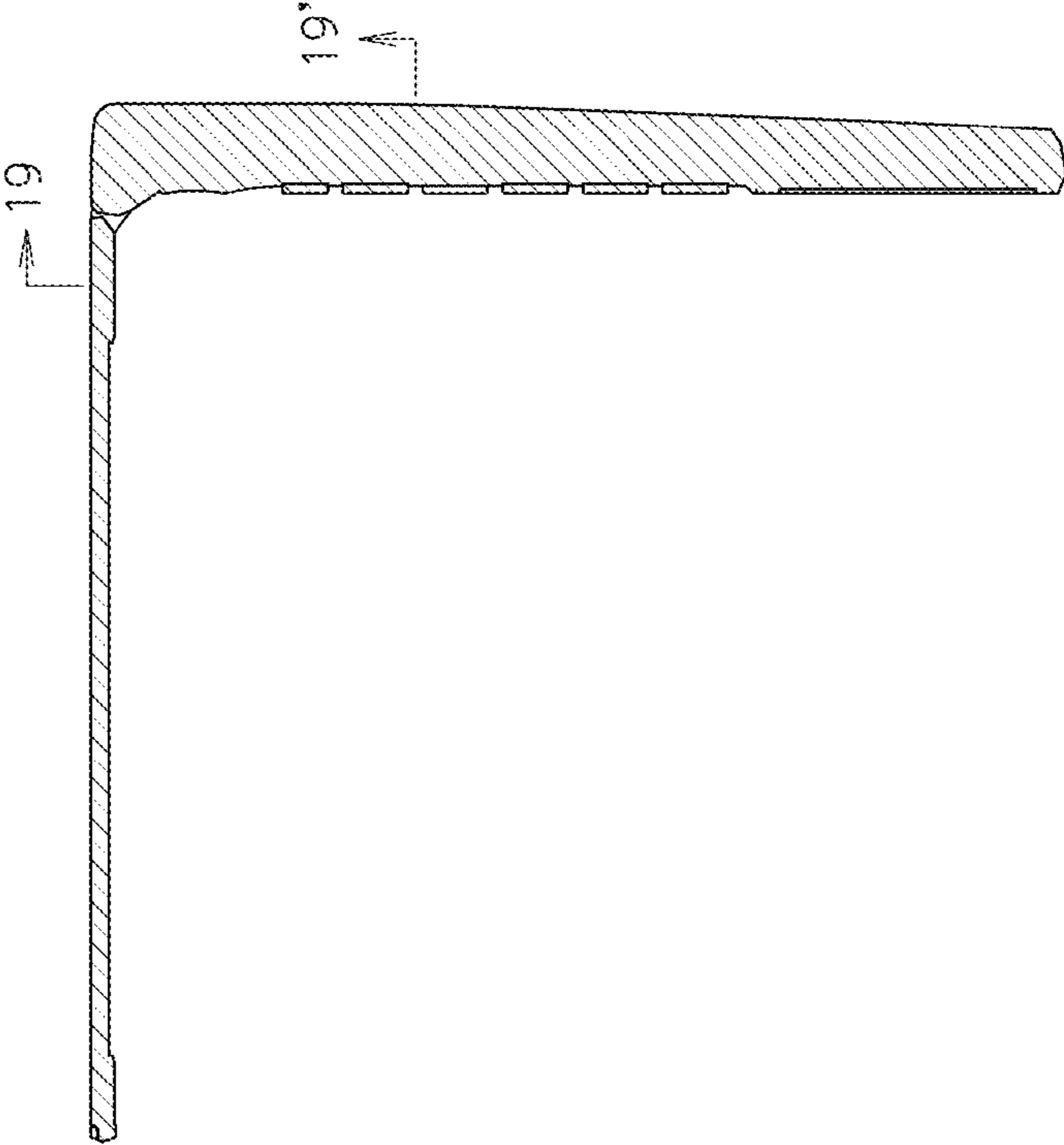

Fig. 18

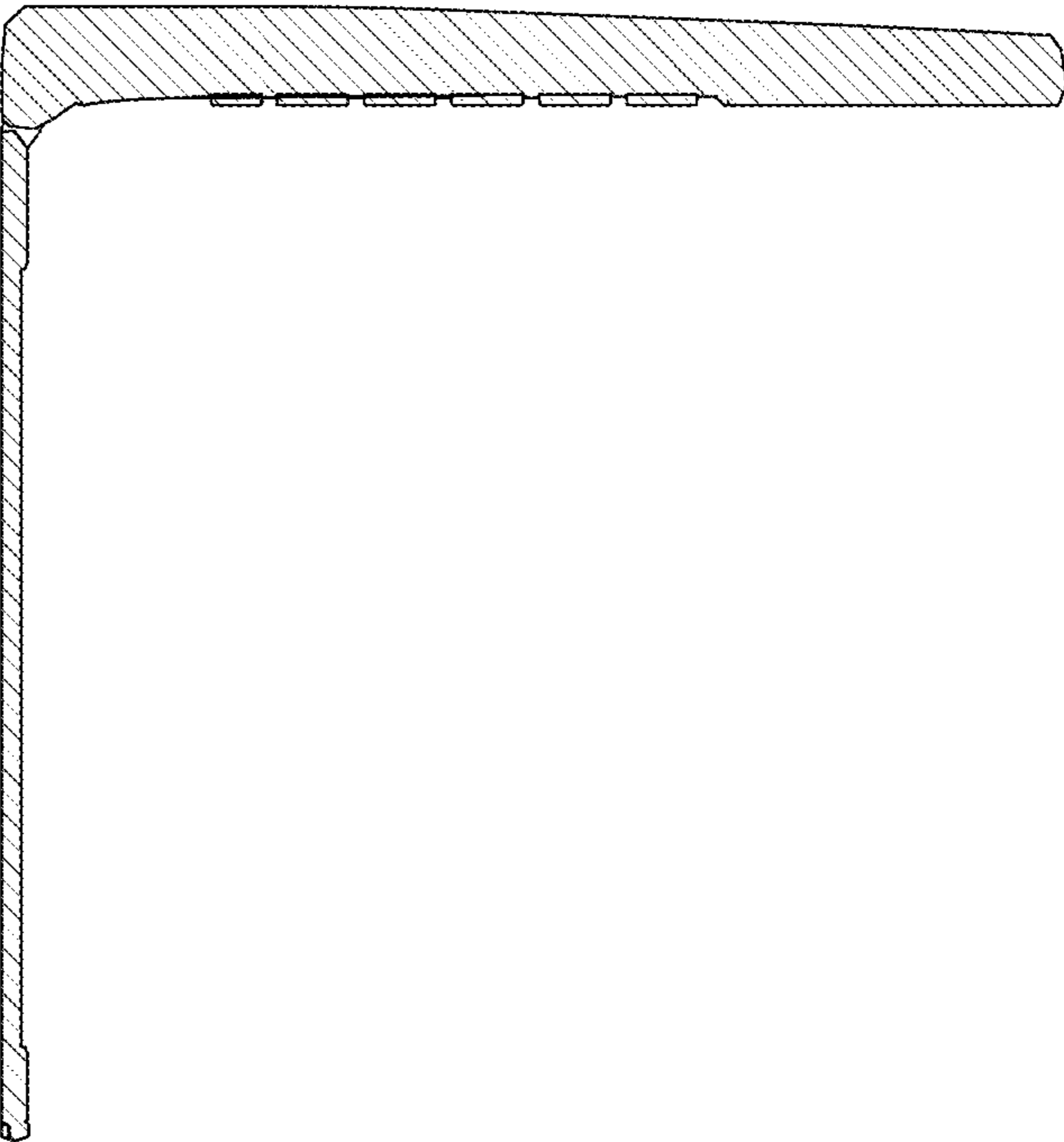



Fig. 19

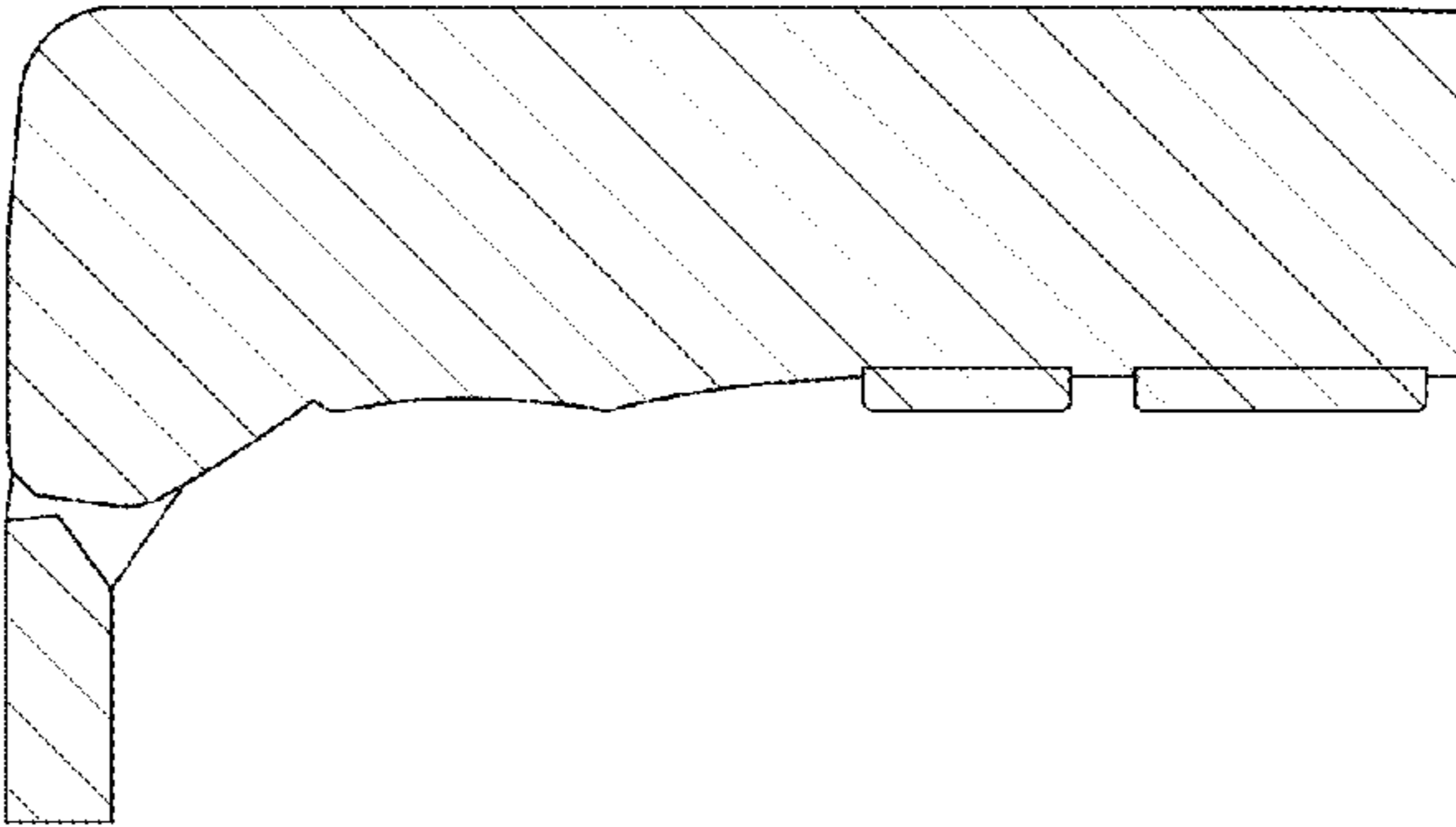

Fig. 20

