



US00D715255S

(12) **United States Design Patent**
Nunez et al.

(10) **Patent No.:** **US D715,255 S**
(45) **Date of Patent:** **** Oct. 14, 2014**

(54) **HEADPHONES**

(71) Applicant: **Jazwares Inc.**, Sunrise, FL (US)

(72) Inventors: **Pedro Nunez**, Sunrise, FL (US); **Judd Zebersky**, Sunrise, FL (US)

(73) Assignee: **Jazwares, LLC**, Sunrise, FL (US)

(**) Term: **14 Years**

(21) Appl. No.: **29/468,277**

(22) Filed: **Sep. 27, 2013**

(51) **LOC (10) Cl.** **14-01**

(52) **U.S. Cl.**
USPC **D14/205**

(58) **Field of Classification Search**
CPC H04R 1/10
USPC D14/205; D29/112; 2/209; 181/129,
181/130, 135; 379/430, 431; 381/370, 380,
381/381; 455/90.3, 575.2
See application file for complete search history.

(56) **References Cited**

U.S. PATENT DOCUMENTS

4,404,434	A *	9/1983	Pelt et al.	381/383
7,072,483	B2 *	7/2006	Lenhard-Backhaus	381/383
D591,263	S *	4/2009	Shimizu	D14/205
D593,995	S *	6/2009	Shimizu	D14/205
D600,674	S *	9/2009	Brennwald	D14/205
D625,705	S *	10/2010	Ohori et al.	D14/205

D632,668	S *	2/2011	Brunner et al.	D14/205
D657,344	S *	4/2012	Brunner et al.	D14/205
D673,136	S *	12/2012	Kelly et al.	D14/205
D673,520	S *	1/2013	Tan	D14/205
D675,595	S *	2/2013	Cho et al.	D14/205
D678,860	S *	3/2013	Hagelin	D14/205
D683,329	S *	5/2013	Hagelin	D14/205
D684,141	S *	6/2013	Takamoto	D14/205
D689,843	S *	9/2013	Lee	D14/205
D699,702	S *	2/2014	Chen	D14/205
D706,241	S *	6/2014	Szymanski et al.	D14/205
2003/0169898	A1 *	9/2003	Arasawa	381/383

* cited by examiner

Primary Examiner — Paula Greene

(74) *Attorney, Agent, or Firm* — Steven M. Greenberg;
CRGO Law

(57) **CLAIM**

The ornamental design for headphones, as shown and described.

DESCRIPTION

FIG. 1 is a front perspective view of the headphones;
FIG. 2 is a rear perspective view thereof;
FIG. 3 is a front view thereof;
FIG. 4 is a rear view thereof;
FIG. 5 is a left side view thereof;
FIG. 6 is a right side view thereof;
FIG. 7 is a top view thereof; and,
FIG. 8 is a bottom view thereof.
The broken lines show unclaimed subject matter only and form no part of the claimed design.

1 Claim, 8 Drawing Sheets

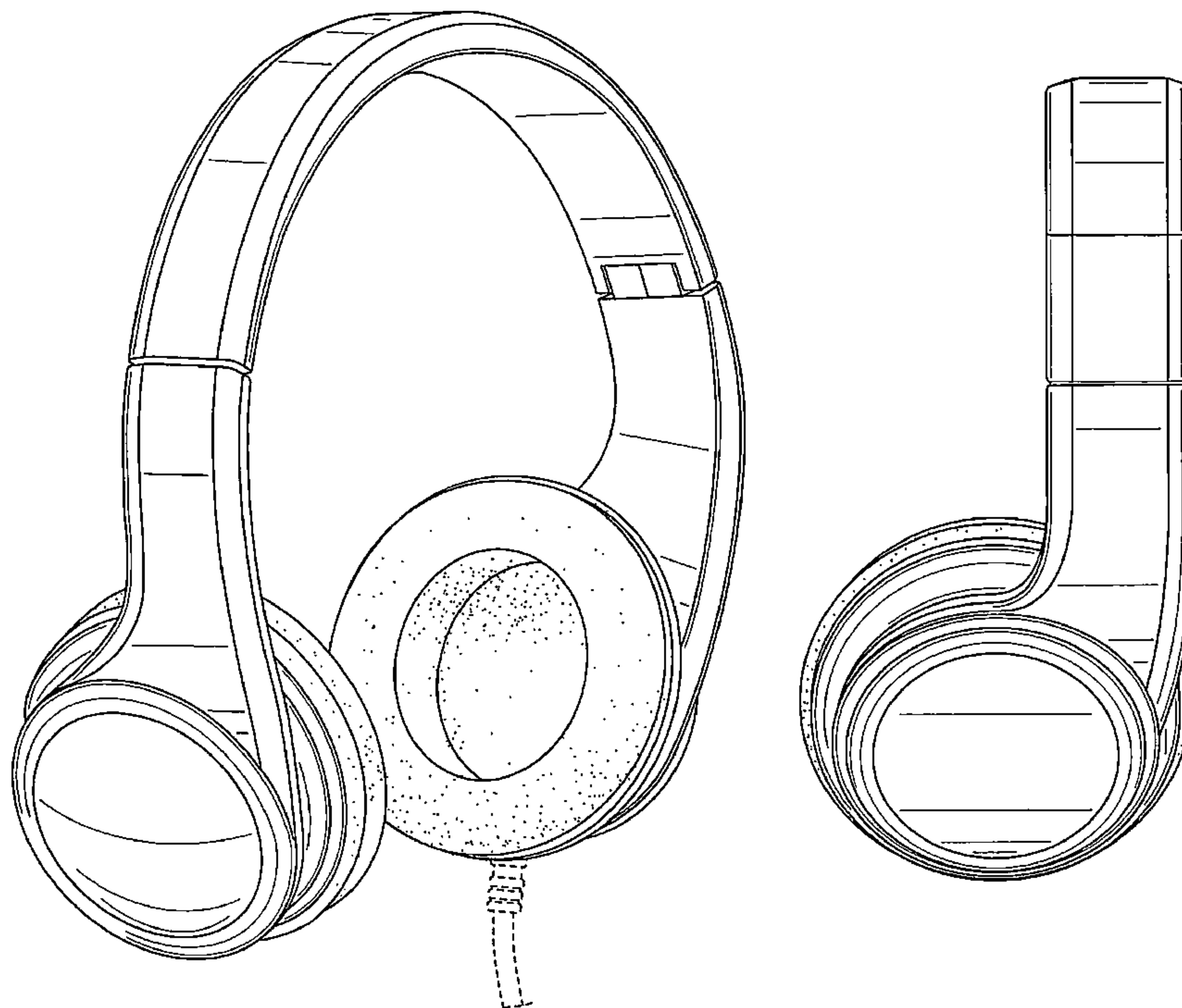

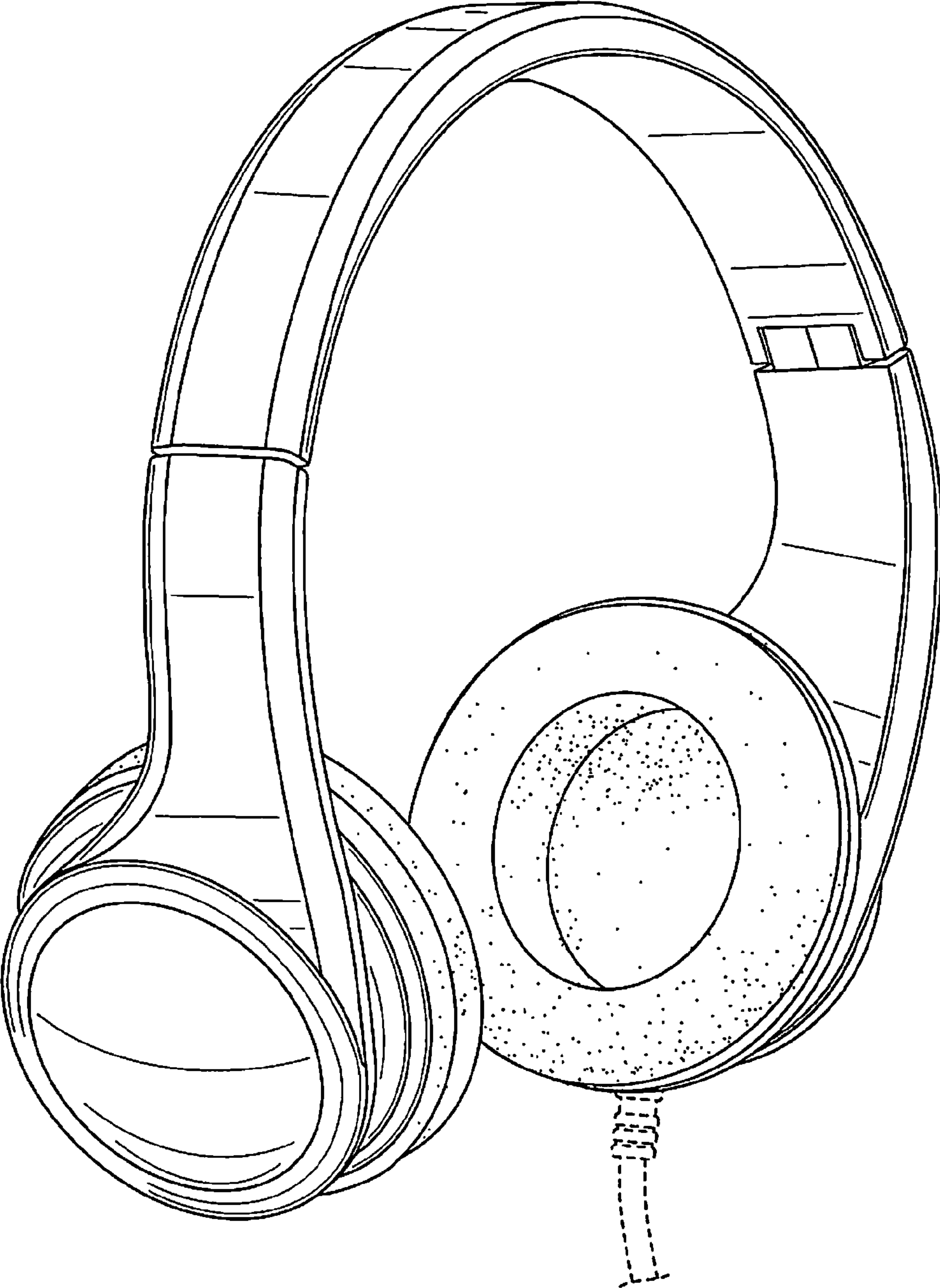

FIG. 1



FIG. 2

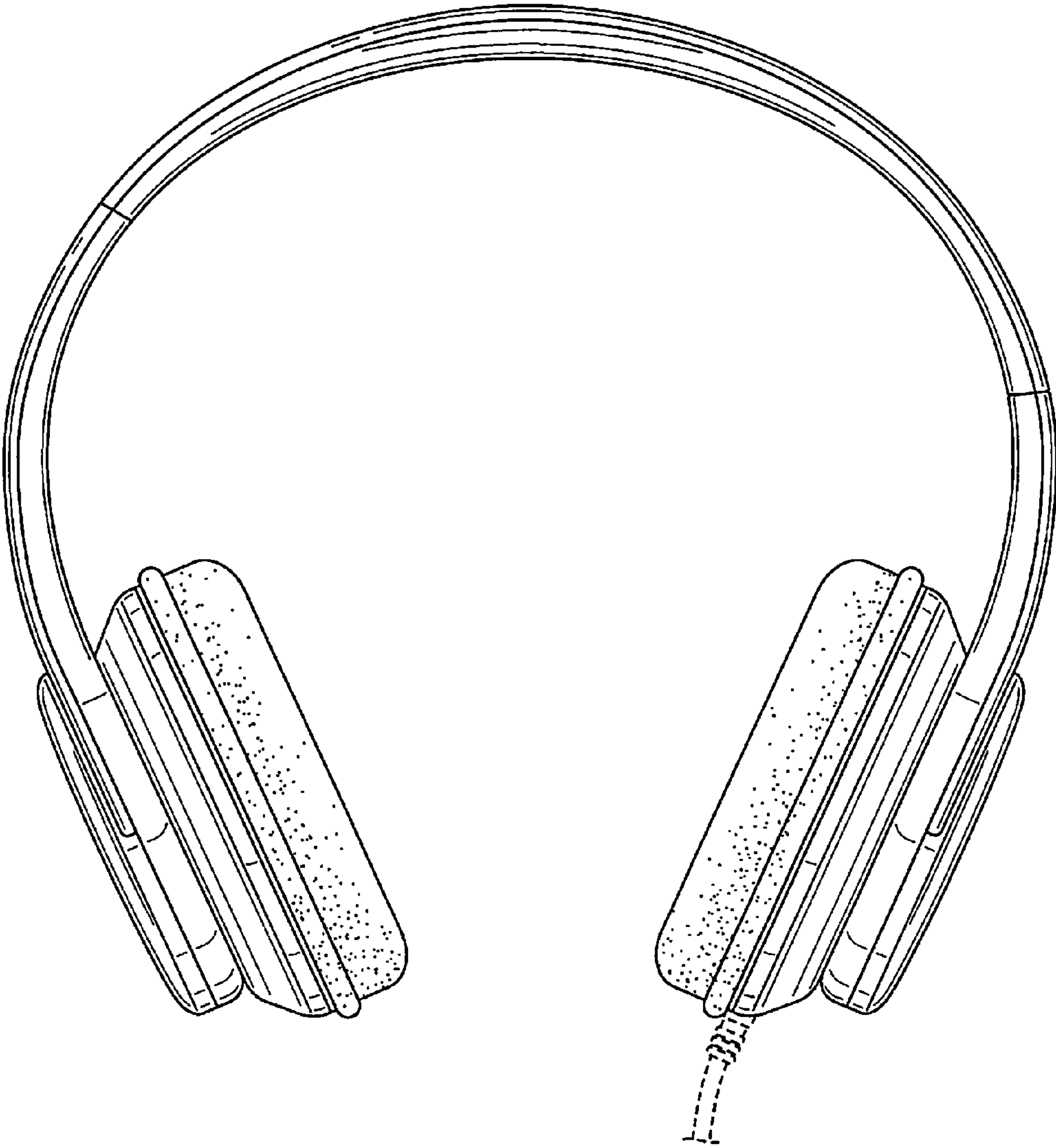

FIG. 3

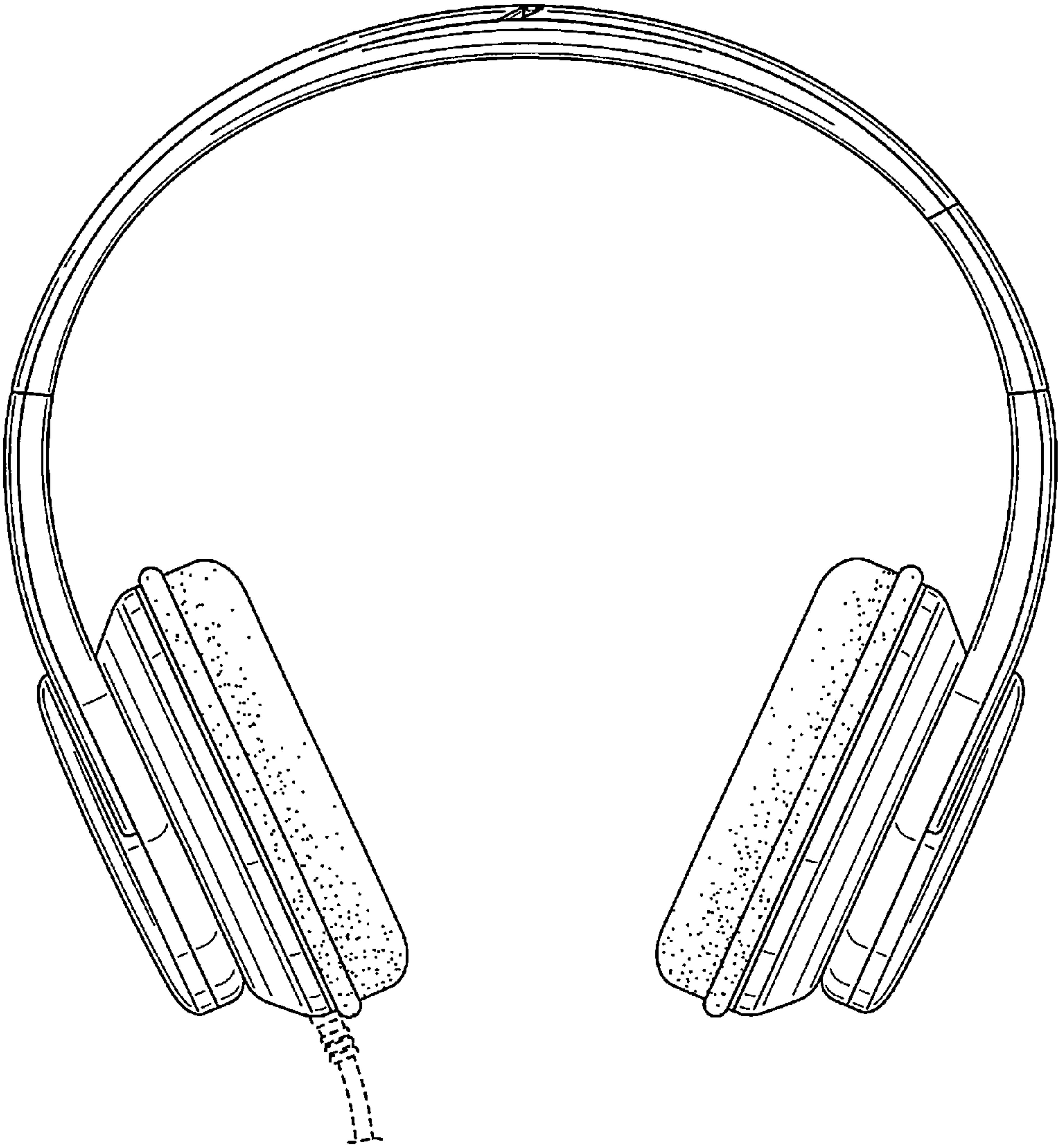

FIG. 4

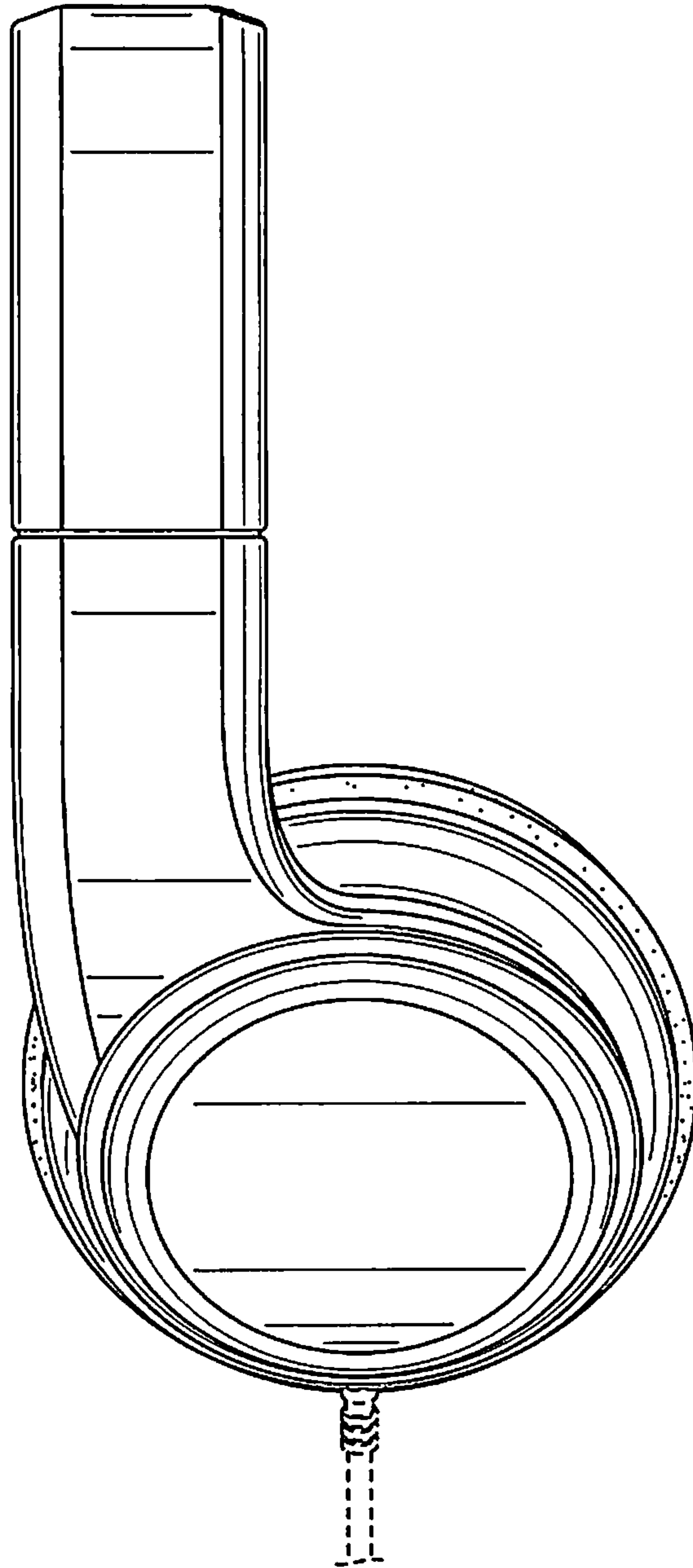

FIG. 5

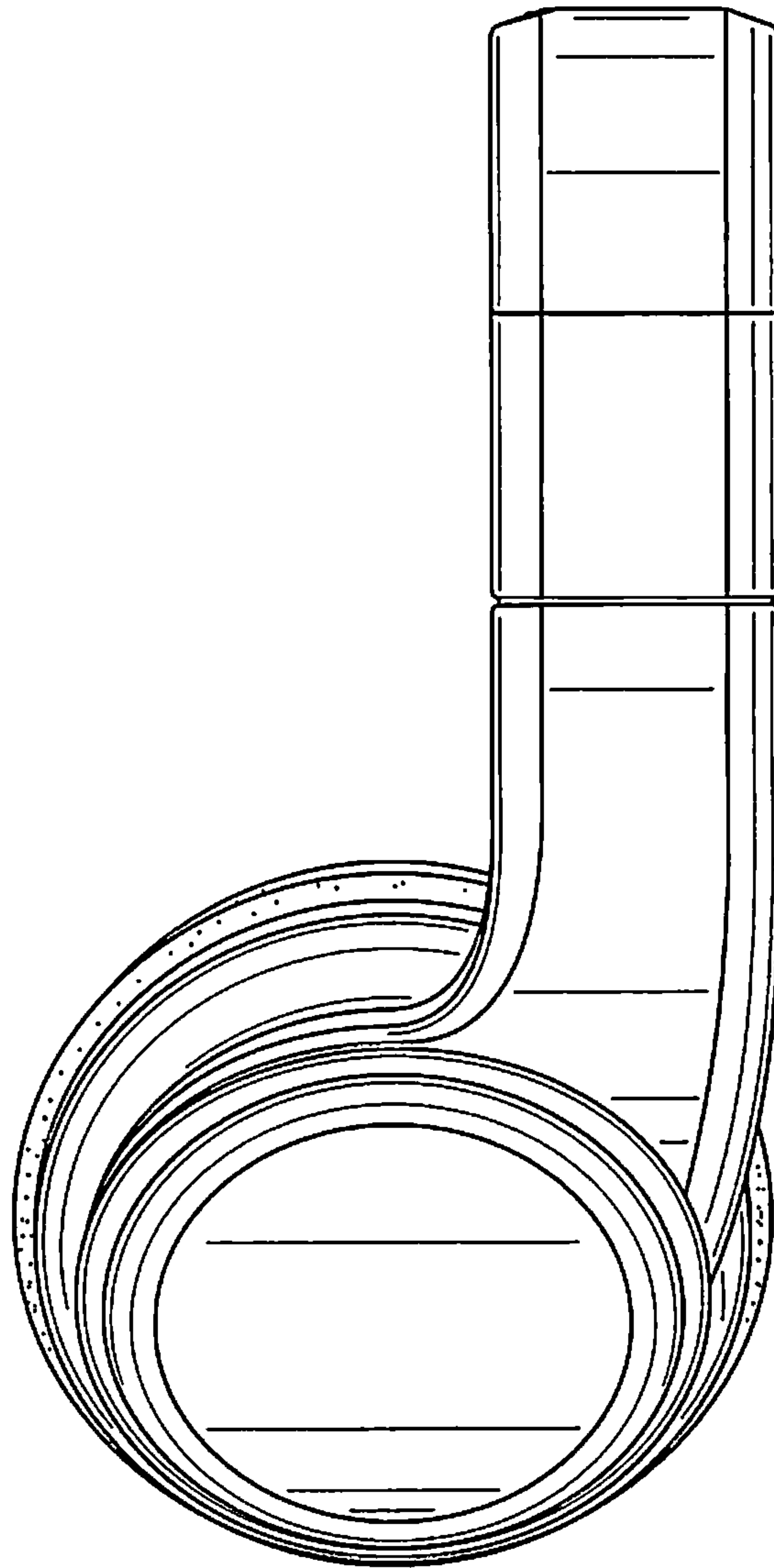

FIG. 6

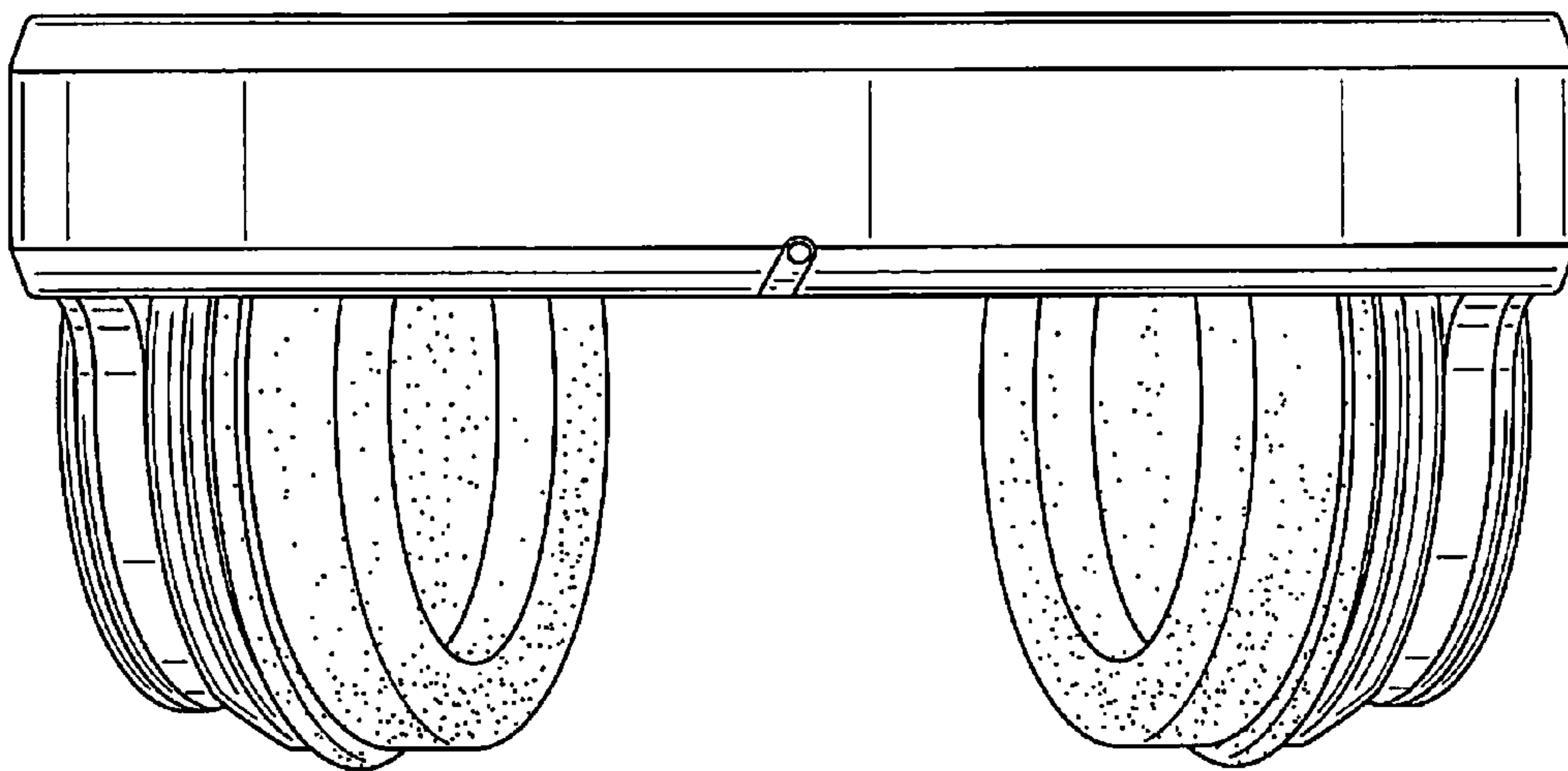

FIG. 7

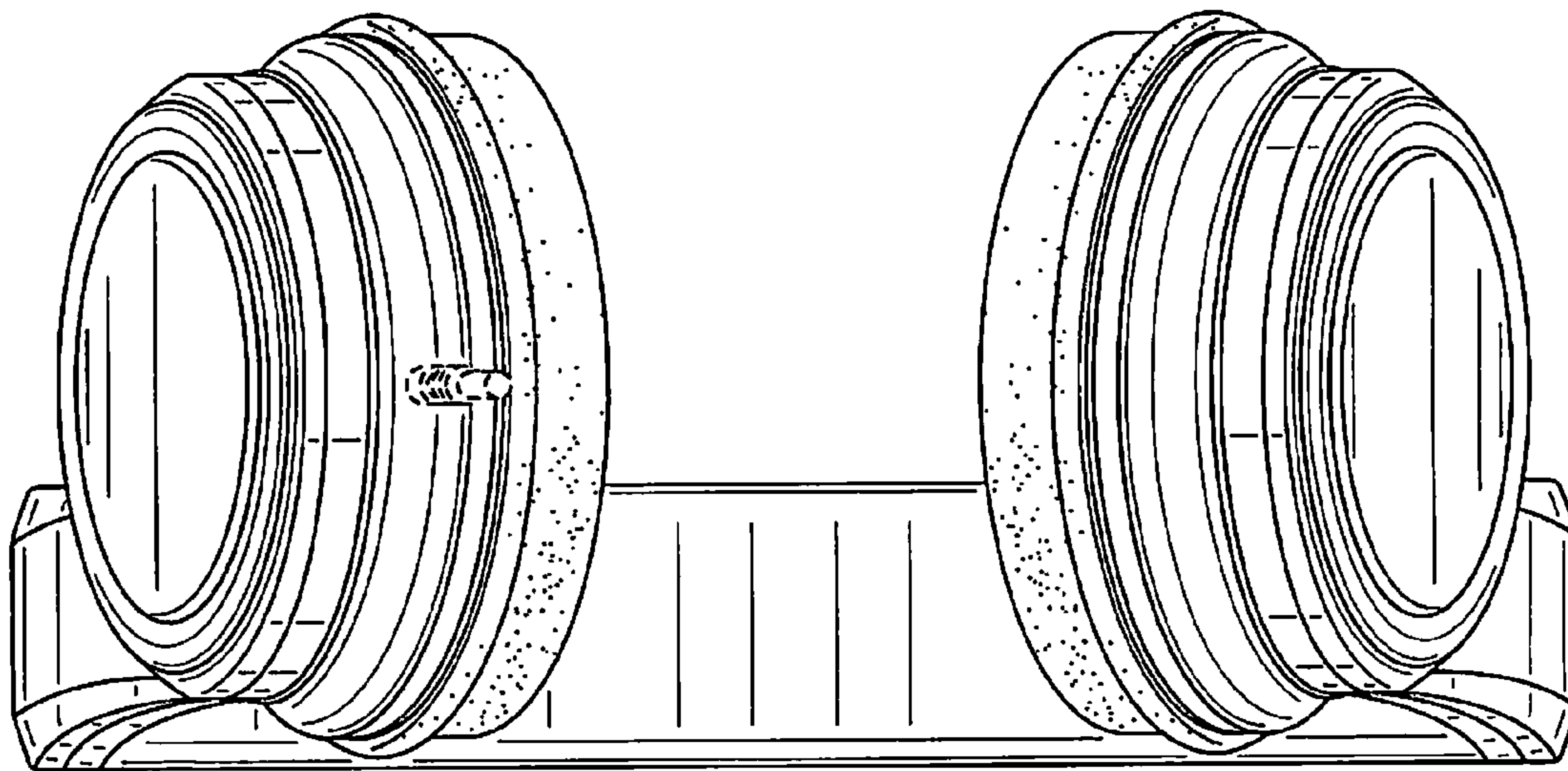

FIG. 8