



US00D715244S

(12) **United States Design Patent**  
**Jang et al.**

(10) **Patent No.:** **US D715,244 S**

(45) **Date of Patent:** **\*\* \*Oct. 14, 2014**

(54) **TELEVISION RECEIVER**

(75) Inventors: **Yonghun Jang**, Seoul (KR); **Sehdong Yoo**, Gyeonggi-do (KR); **Yunhwan Sung**, Seoul (KR)

(73) Assignee: **LG Electronics Inc.**, Seoul (KR)

(\*) Notice: This patent is subject to a terminal disclaimer.

(\*\*) Term: **14 Years**

(21) Appl. No.: **29/407,347**

(22) Filed: **Nov. 28, 2011**

(51) **LOC (10) Cl.** ..... **14-03**

(52) **U.S. Cl.**  
USPC ..... **D14/126**

(58) **Field of Classification Search**  
USPC ..... D14/126; 312/7.2; 348/836, 838, 180, 348/184, 325, 739; 341/12; 248/917-924, 248/465; 345/104, 133, 156, 168, 87, 173; 720/605, 600, 655; 455/347  
See application file for complete search history.

(56) **References Cited**

**U.S. PATENT DOCUMENTS**

D470,466	S	*	2/2003	Forlenza et al.	.....	D14/128
D611,439	S	*	3/2010	Suzuki et al.	.....	D14/126
D624,512	S	*	9/2010	Kim et al.	.....	D14/126
D636,748	S	*	4/2011	Kim et al.	.....	D14/126
D637,167	S	*	5/2011	Tsai et al.	.....	D14/126
D638,390	S	*	5/2011	Honda	.....	D14/126
D639,256	S	*	6/2011	Lee et al.	.....	D14/126
D646,243	S	*	10/2011	Honda	.....	D14/126

D661,272	S	*	6/2012	Kim et al.	.....	D14/126
D668,236	S	*	10/2012	Wang	.....	D14/126
D671,513	S	*	11/2012	Jang et al.	.....	D14/126
D680,508	S	*	4/2013	Kim et al.	.....	D14/126
D682,229	S	*	5/2013	Lee et al.	.....	D14/126
D682,233	S	*	5/2013	Yoo et al.	.....	D14/126
D682,234	S	*	5/2013	Lee et al.	.....	D14/126
D682,235	S	*	5/2013	Lee et al.	.....	D14/126
D691,604	S	*	10/2013	Seong et al.	.....	D14/374
D694,210	S	*	11/2013	Fujii et al.	.....	D14/126
D697,884	S	*	1/2014	Lee	.....	D14/126

\* cited by examiner

*Primary Examiner* — Robert M Spear

*Assistant Examiner* — Eliza Bennett-Hattan

(74) *Attorney, Agent, or Firm* — Morgan, Lewis & Bockius LLP

(57) **CLAIM**

The ornamental design for a television receiver, as shown and described.

**DESCRIPTION**

FIG. 1 is a perspective view of a television receiver showing our new design;  
FIG. 2 is a front view thereof;  
FIG. 3 is a rear view thereof;  
FIG. 4 is a left side view thereof;  
FIG. 5 is a right side view thereof;  
FIG. 6 is a top plan view thereof;  
FIG. 7 is a bottom plan view thereof;  
FIG. 8 is an enlarged view of section 8 in FIG. 4; and,  
FIG. 9 is an enlarged view of section 9 in FIG. 4.  
The broken lines in the drawings depict environmental subject matter only and form no part of the claimed design.

**1 Claim, 8 Drawing Sheets**

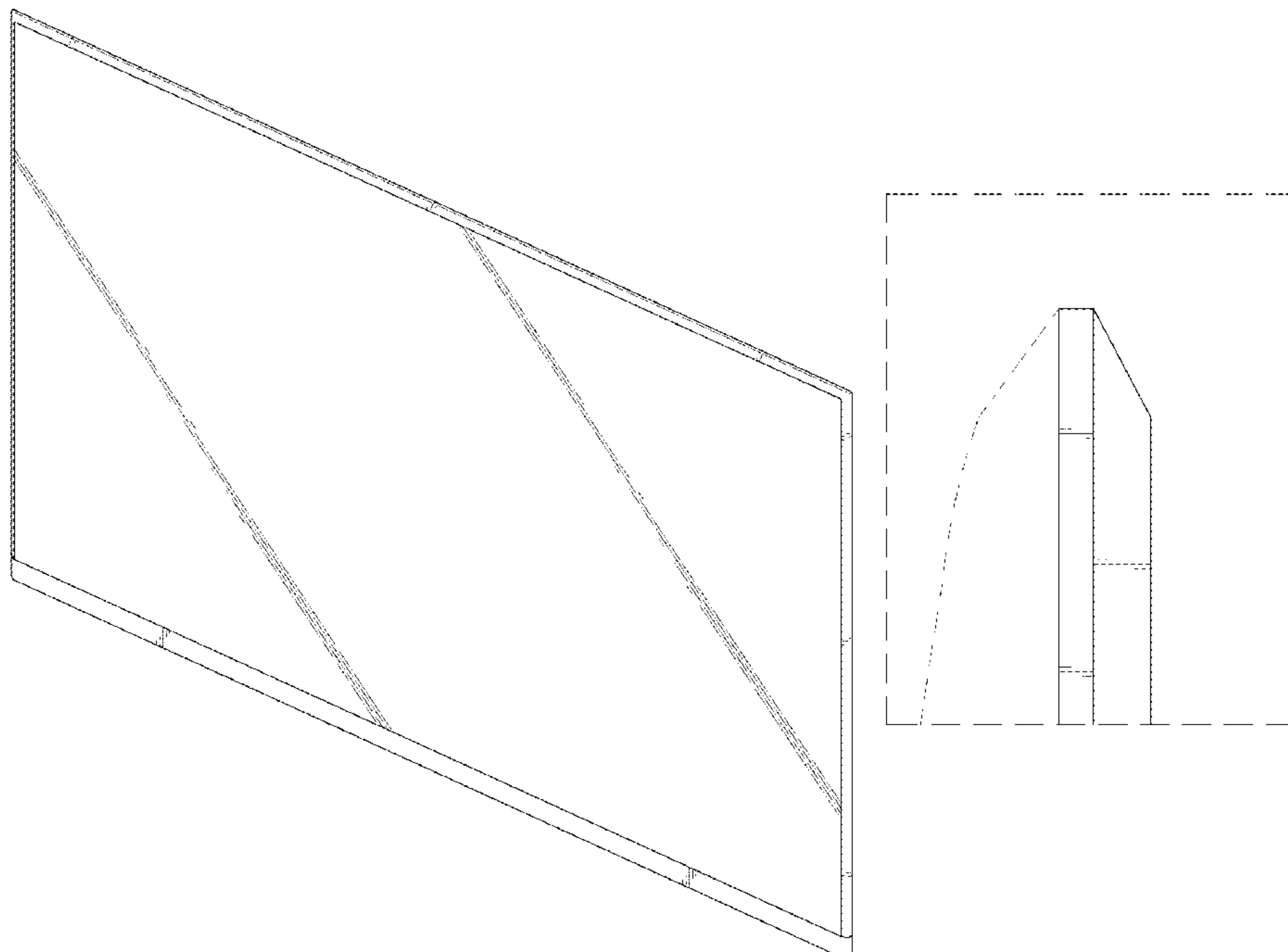

FIG. 1

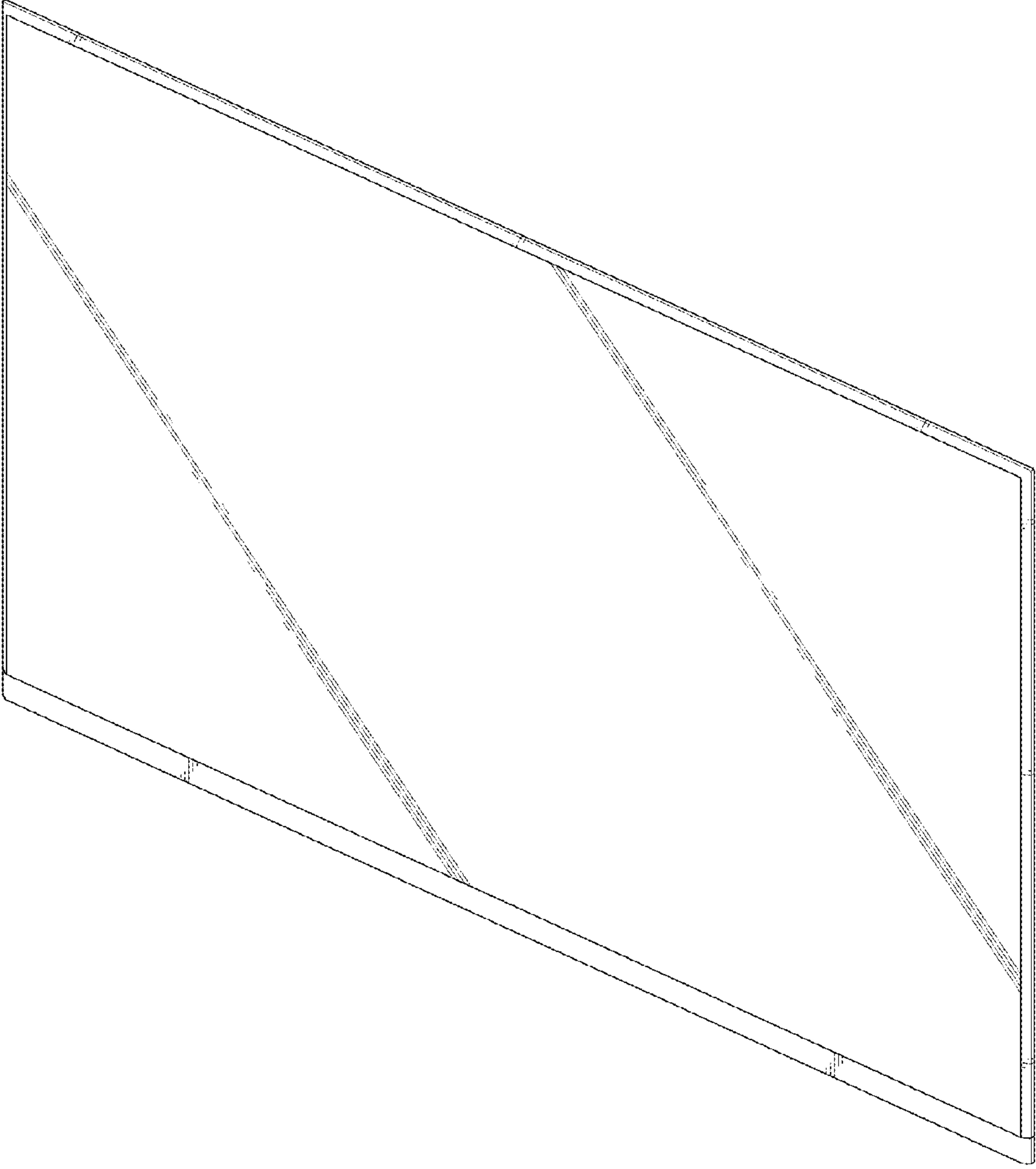

FIG. 2

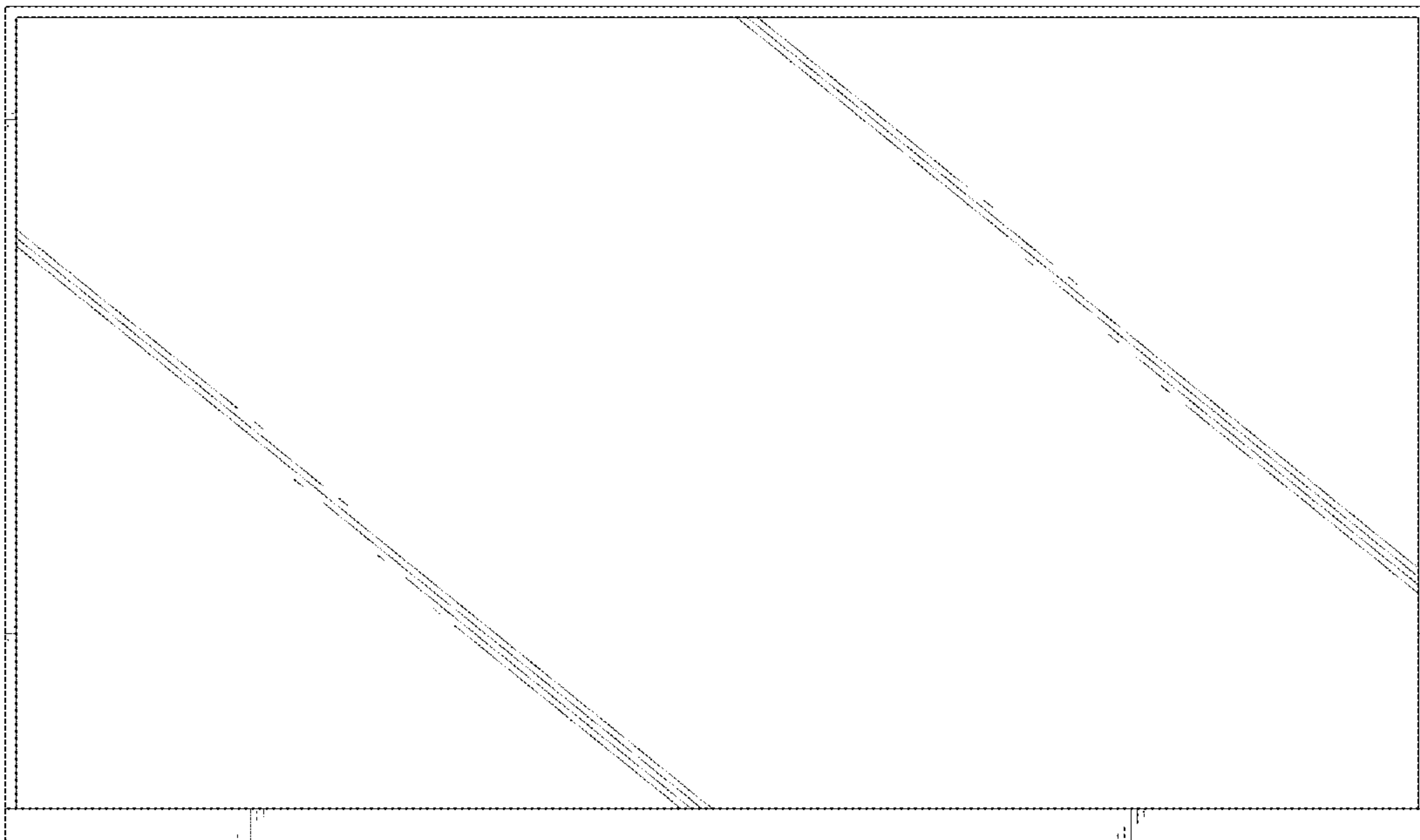

FIG. 3

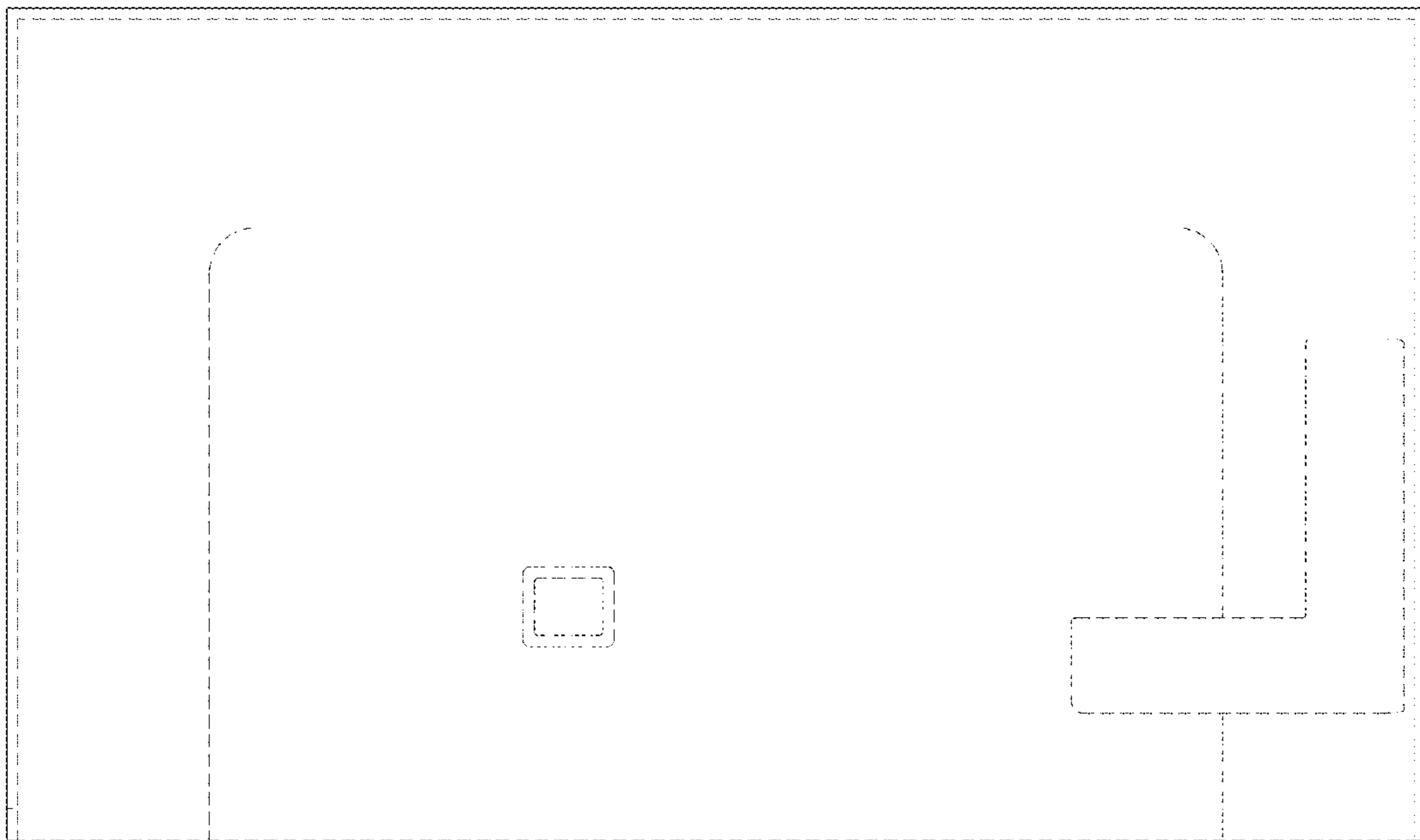

FIG. 4

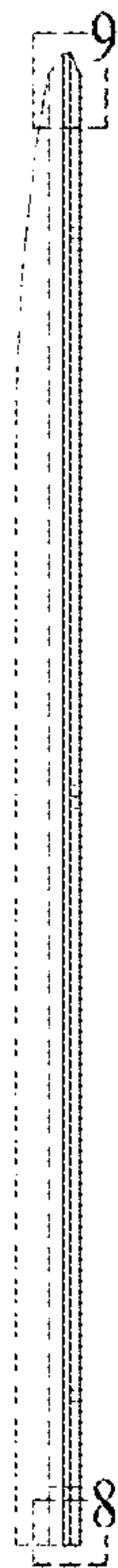

FIG. 5

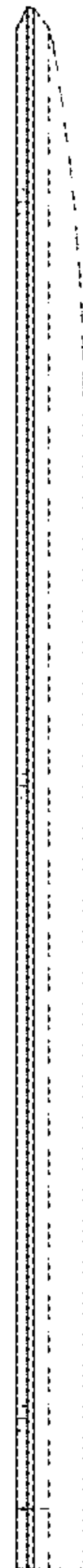

FIG. 6

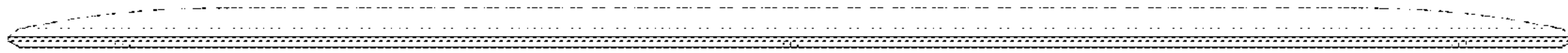

FIG. 7

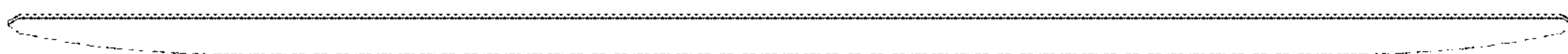

FIG. 8

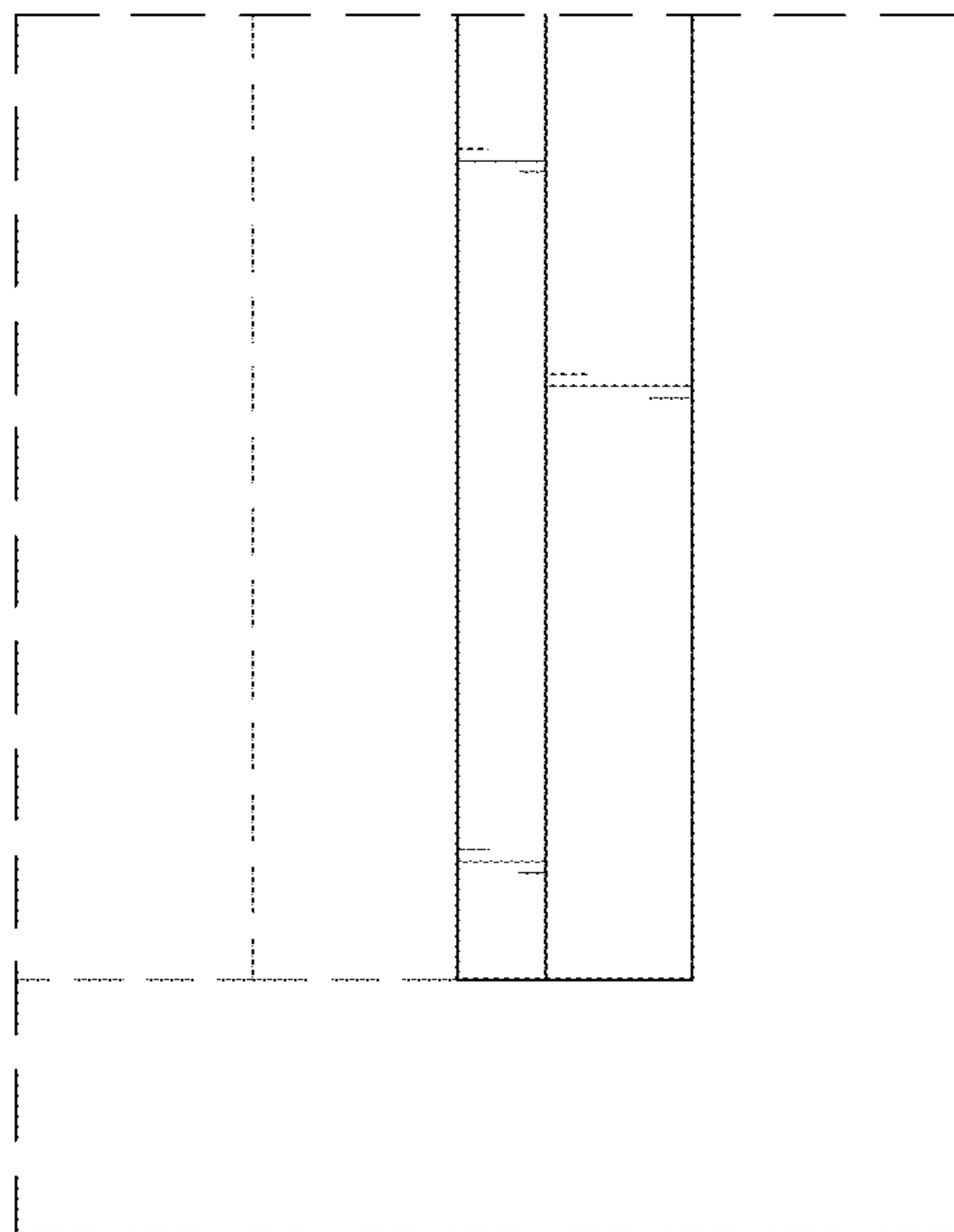



FIG. 9

