



US00D715185S

(12) **United States Design Patent**  
**Iannello et al.**

(10) **Patent No.:** **US D715,185 S**

(45) **Date of Patent:** **\*\* Oct. 14, 2014**

(54) **BUCKLE MEMBER**

(56) **References Cited**

(71) Applicant: **Illinois Tool Works Inc.**, Glenview, IL (US)

U.S. PATENT DOCUMENTS

(72) Inventors: **Christopher A. J. Iannello**, Rolling Meadows, IL (US); **Martin J. Nilsen**, Hampshire, IL (US); **Michael B. Grimm**, Evanston, IL (US)

D386,124 S *	11/1997	Anscher .....	D11/216
D471,487 S *	3/2003	Uehara et al. ....	D11/216
D502,125 S *	2/2005	Yoshiguchi .....	D11/216
D535,912 S *	1/2007	Pontaoe .....	D11/216
D535,915 S *	1/2007	Yang .....	D11/216
D638,331 S *	5/2011	Paik .....	D11/216
D680,900 S *	4/2013	Grimm .....	D11/216

(73) Assignee: **Illinois Tool Works Inc.**, Glenview, IL (US)

\* cited by examiner

(\*\*) Term: **14 Years**

*Primary Examiner* — Ralf Seifert

(21) Appl. No.: **29/483,794**

(74) *Attorney, Agent, or Firm* — Mark W. Croll; Paul F. Donovan

(22) Filed: **Mar. 3, 2014**

(57) **CLAIM**

The ornamental design for a buckle member, as shown and described.

(51) **LOC (10) Cl.** ..... **02-07**

**DESCRIPTION**

(52) **U.S. Cl.**  
USPC ..... **D11/216**

FIG. 1 is a perspective view of the buckle member showing the new design;

(58) **Field of Classification Search**  
CPC ..... A44B 11/00; A44B 11/25; A44B 21/00; A44B 17/00

FIG. 2 is a top view thereof;

USPC ..... D11/1-2, 200-201, 206-210, 214-218; 24/163 R, 169-171, 173, 177-179, 191, 24/194-195, 197, 200, 614-616, 625, 198, 24/578.11, 578.1, 163 K, 114, 455, 573.11, 24/598.2; D8/394, 395

FIG. 3 is a bottom view thereof;

FIG. 4 is a left side view thereof;

FIG. 5 is a right side view thereof;

FIG. 6 is a front end view thereof; and,

FIG. 7 is a back end thereof.

The broken line portions of the disclosure are for illustrative purposes only and form no part of the claimed design.

See application file for complete search history.

**1 Claim, 4 Drawing Sheets**

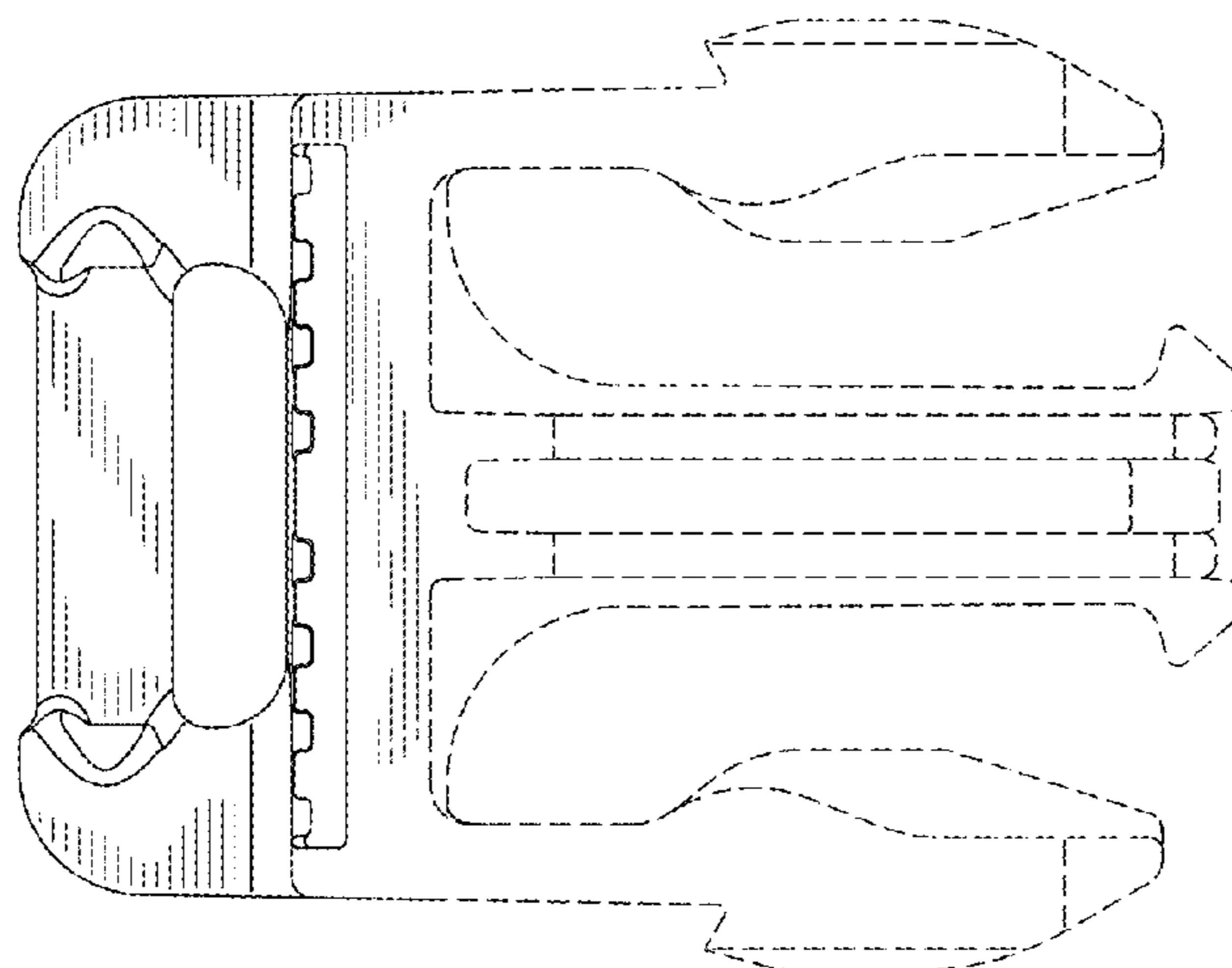

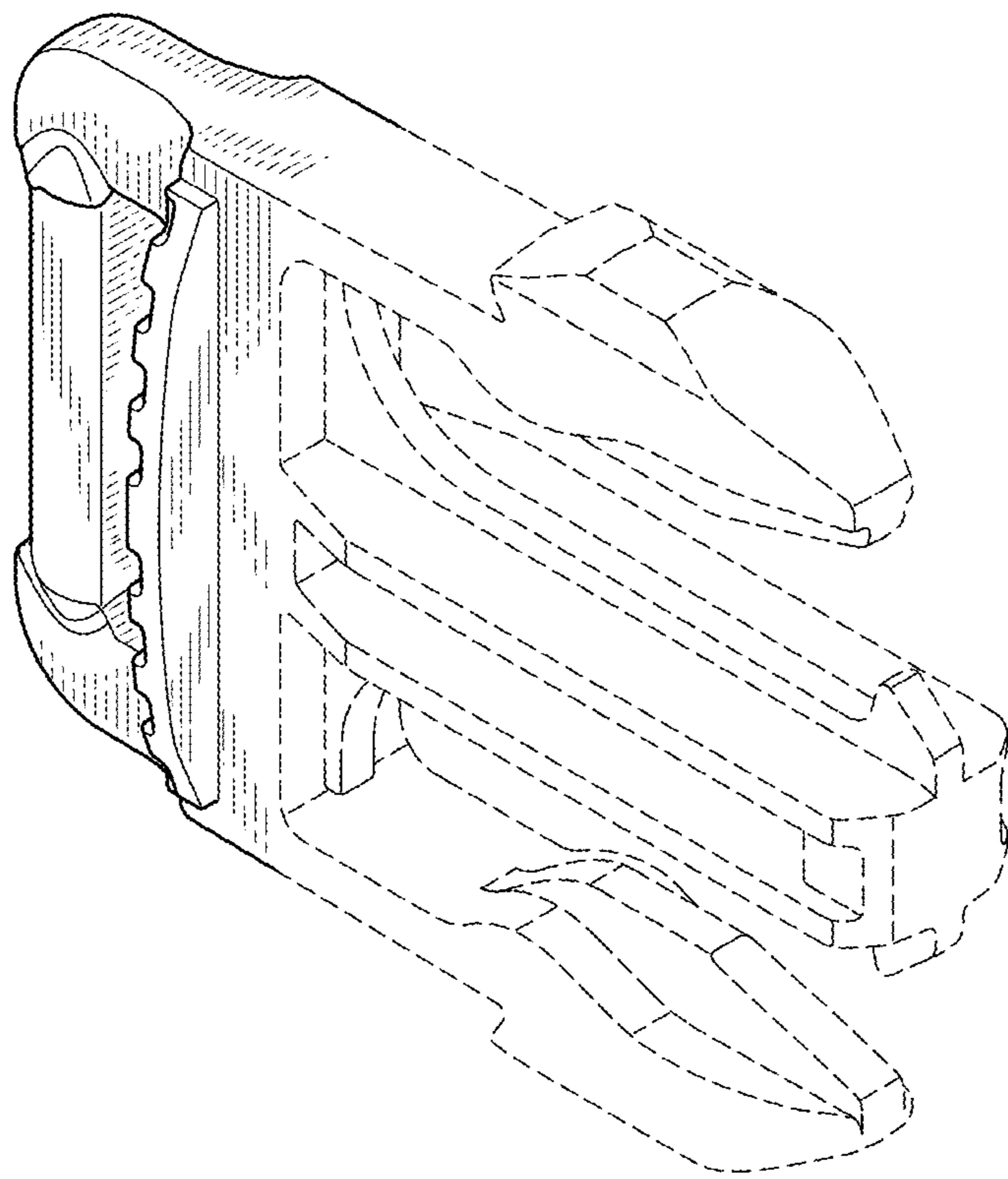

FIG. 1

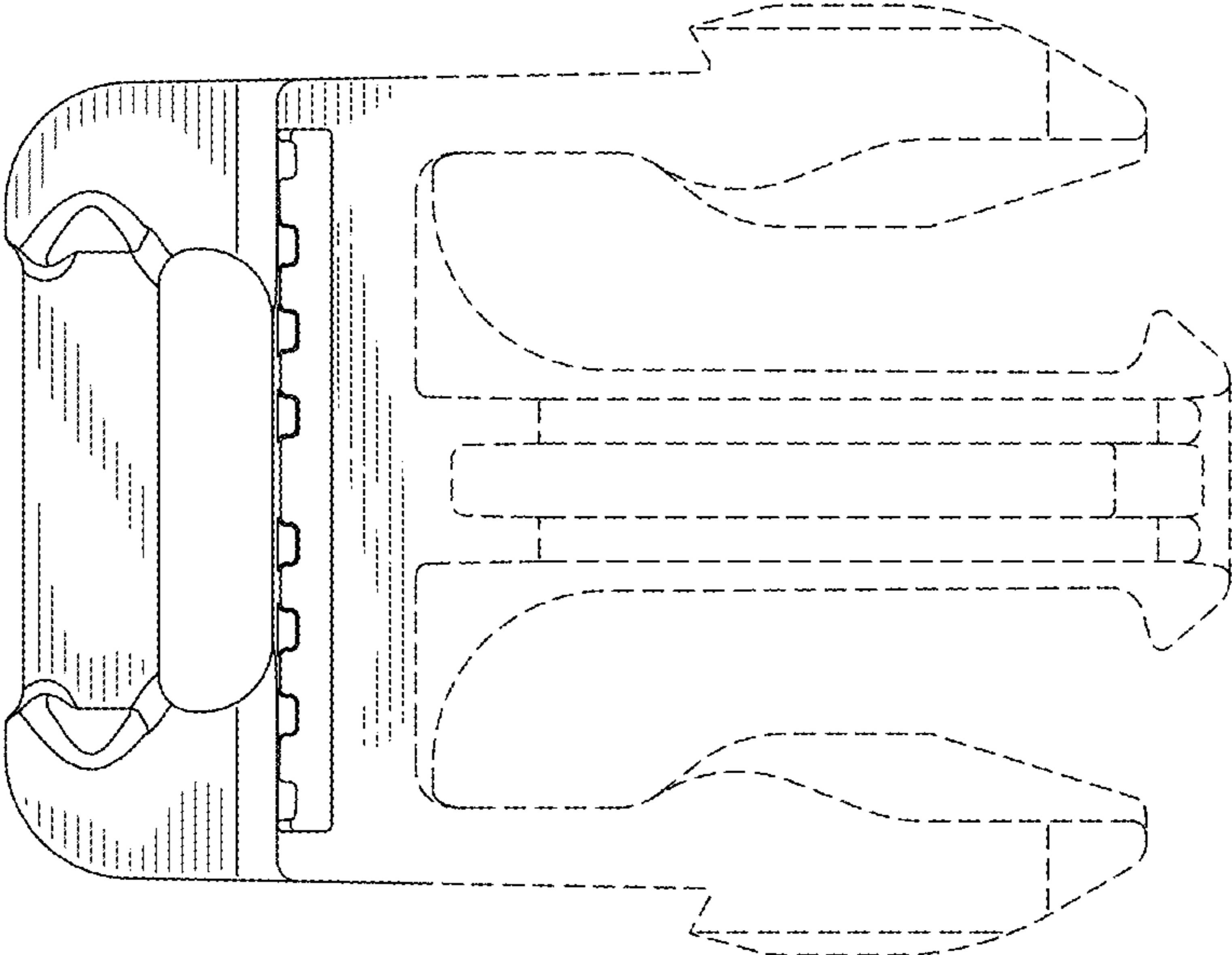

FIG. 2

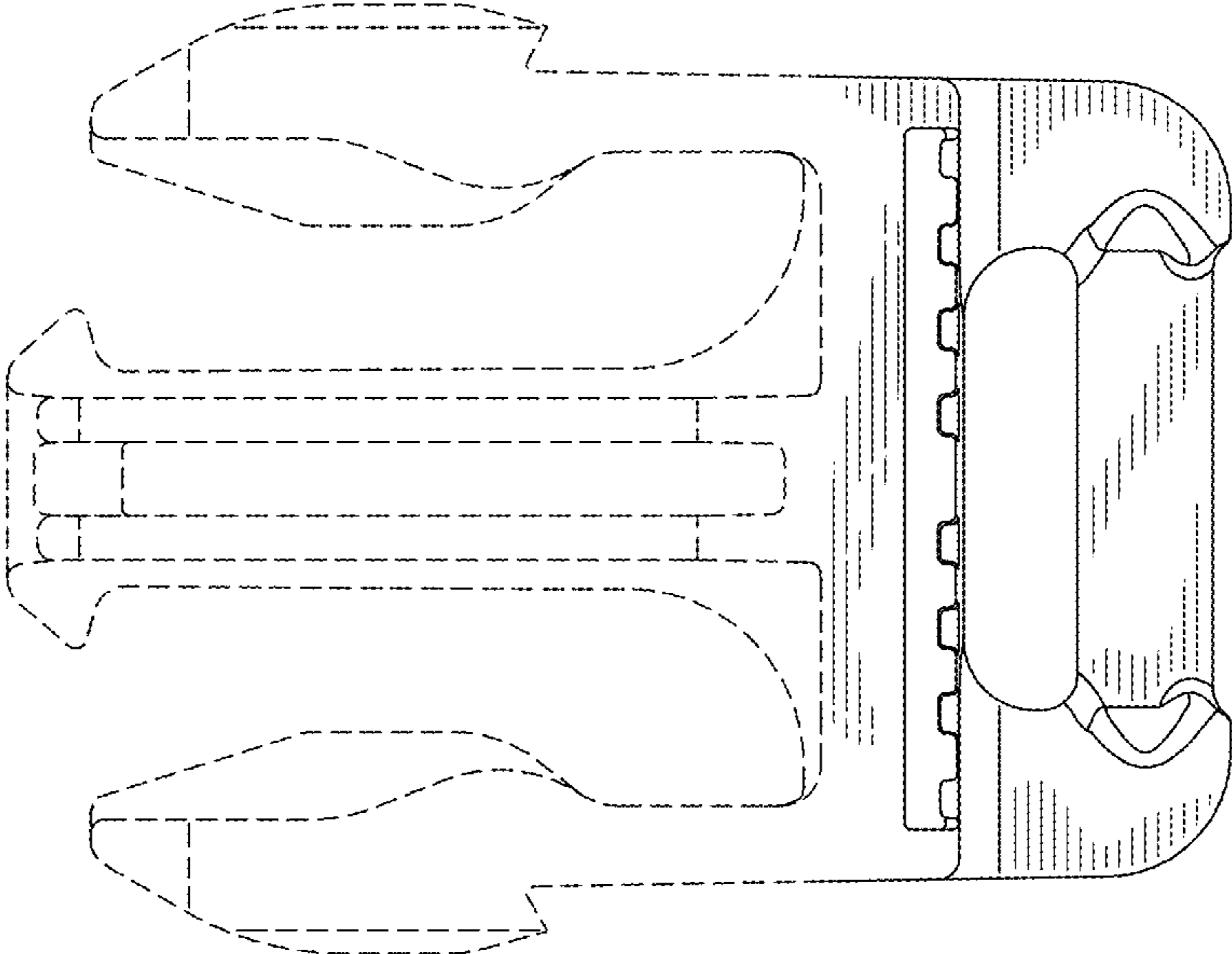

FIG. 3

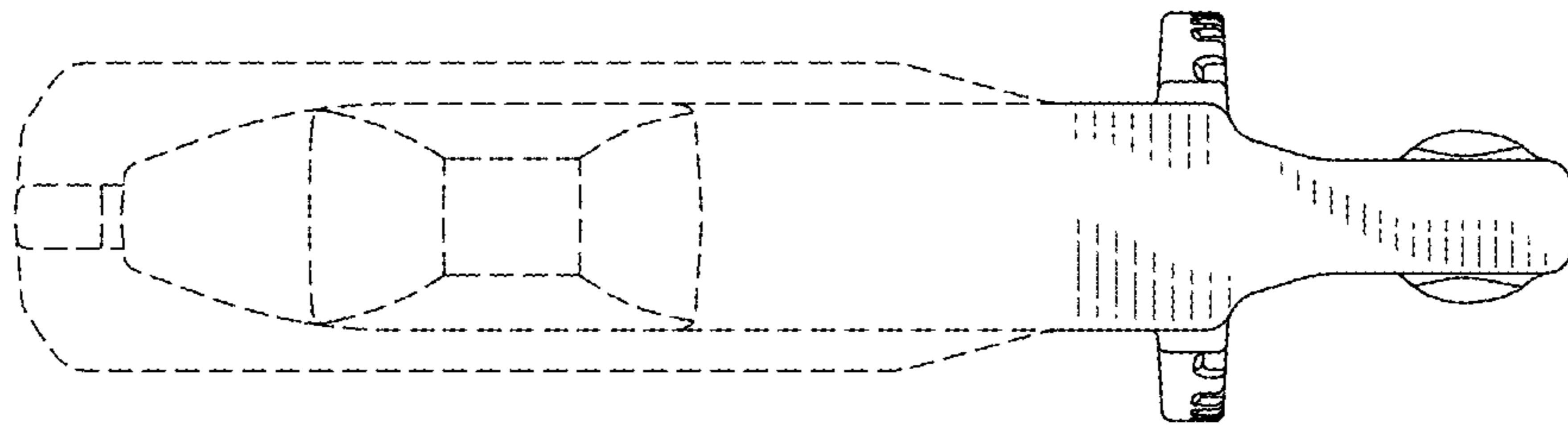

FIG. 4

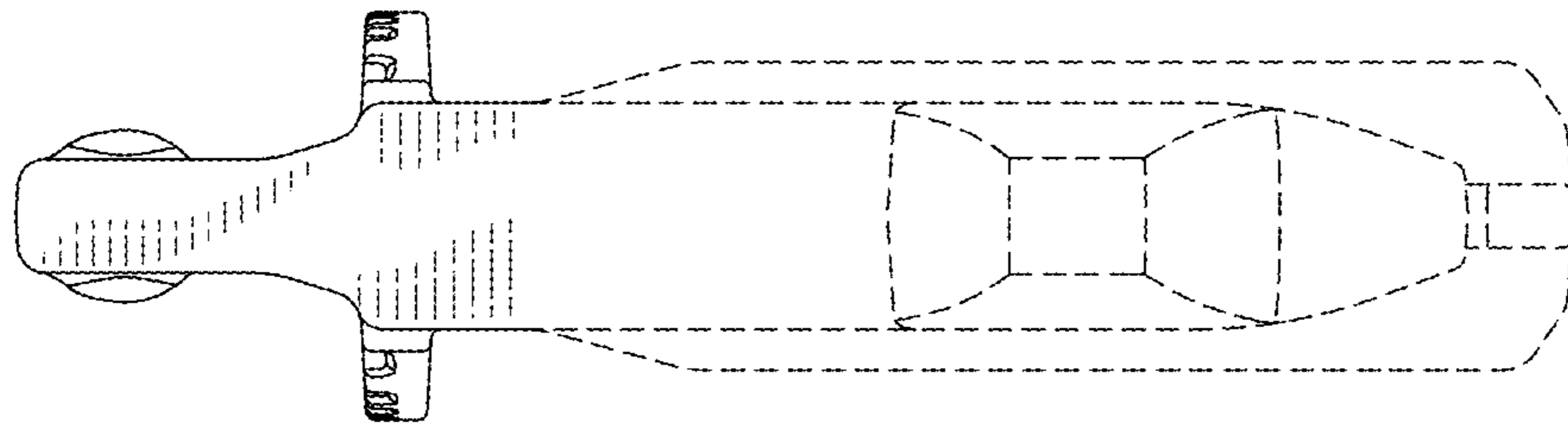

FIG. 5

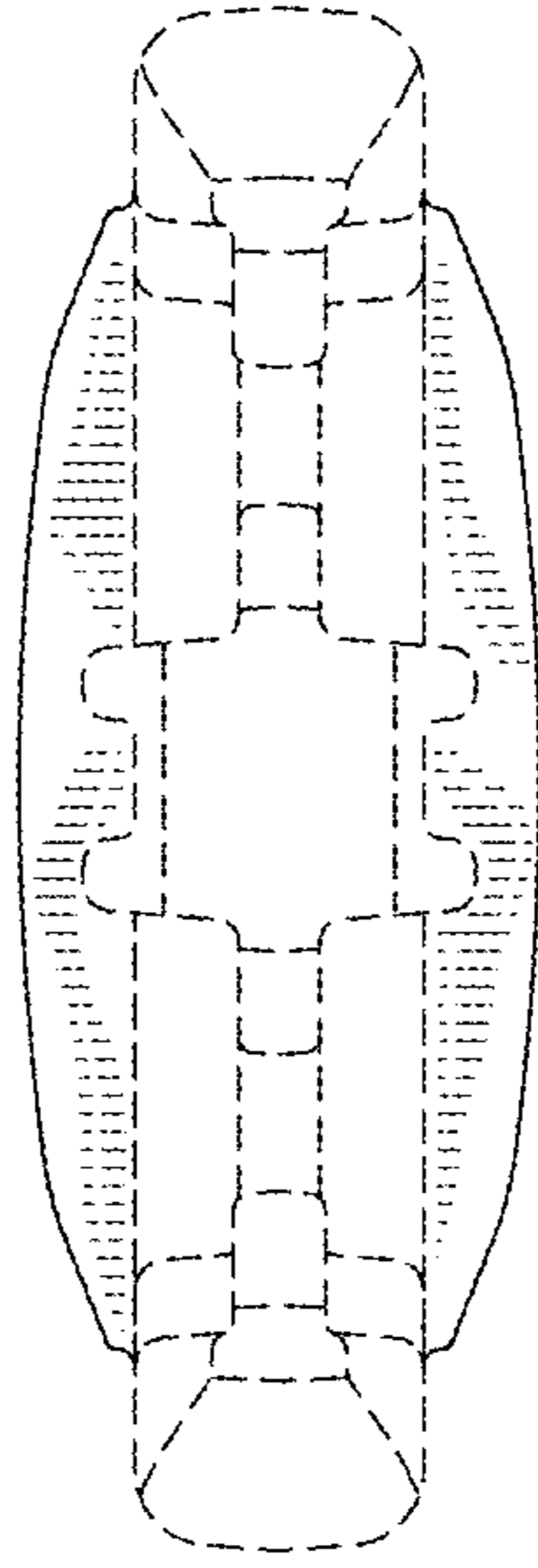

FIG. 6

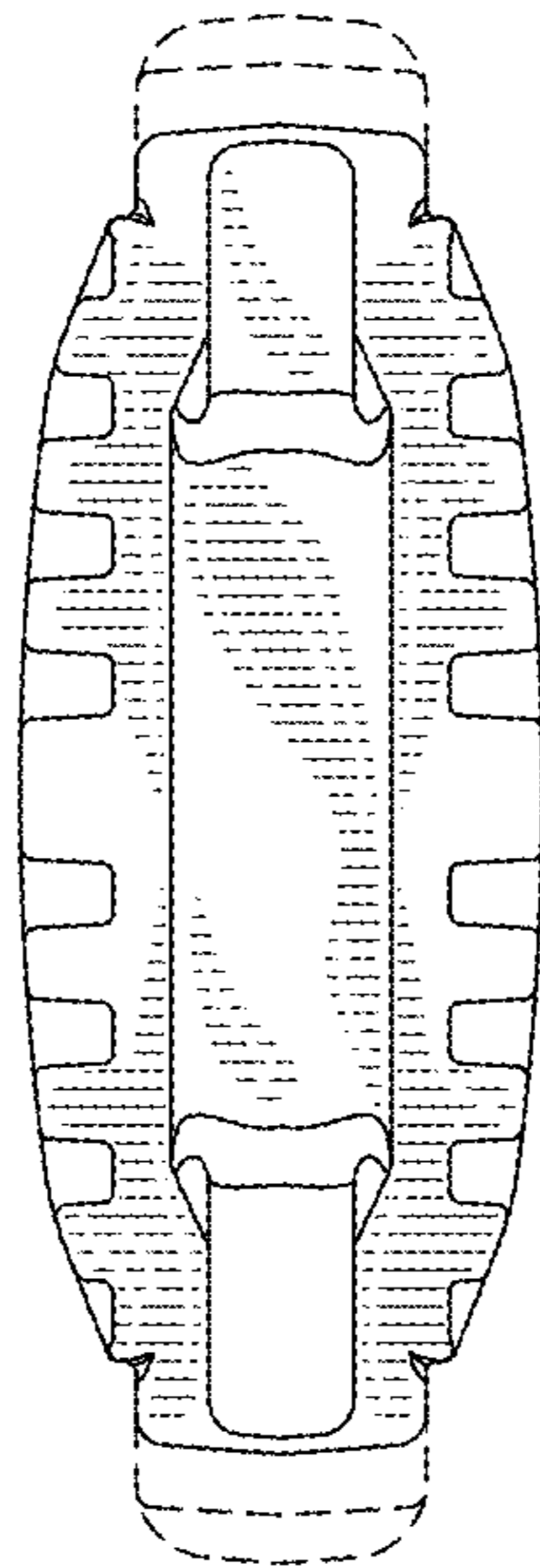

FIG. 7