



US00D715120S

(12) **United States Design Patent**  
**Bashir**

(10) **Patent No.:** **US D715,120 S**  
(45) **Date of Patent:** **\*\* Oct. 14, 2014**

- (54) **TWIN ACTION DECAPPING PLIERS**
- (71) Applicant: **Mohammad Bashir**, Lorton, VA (US)
- (72) Inventor: **Mohammad Bashir**, Lorton, VA (US)
- (\*\*) Term: **14 Years**
- (21) Appl. No.: **29/453,151**
- (22) Filed: **Apr. 25, 2013**
- (51) **LOC (10) Cl.** ..... **08-05**
- (52) **U.S. Cl.**  
USPC ..... **D8/52**
- (58) **Field of Classification Search**  
CPC ..... B67B 7/162  
USPC ..... D8/4, 14, 51, 52, 54-56, 58, 105, 107,  
D8/75-81; 7/125-137, 143-147; 81/300,  
81/342, 348, 355-362, 364-366, 385-404,  
81/407-418, 424.5, 426, 426.5, 427,  
81/427.5; D24/133, 148, 153  
See application file for complete search history.

8,136,188 B2 3/2012 Bell  
8,276,486 B2\* 10/2012 Hsieh ..... 81/424  
2012/0247277 A1\* 10/2012 Moore ..... 81/3.44

\* cited by examiner

*Primary Examiner* — Deanna L Pratt  
*Assistant Examiner* — Harold Blackwell, II  
(74) *Attorney, Agent, or Firm* — Bacon & Thomas, PLLC

(57) **CLAIM**  
The ornamental design for a twin action decapping pliers, as shown and described.

**DESCRIPTION**

FIG. 1 is a top perspective view of a twin action decapping pliers showing my new design;  
FIG. 2 is a top plan view of the twin action decapping pliers shown in FIG. 1;  
FIG. 3 is a bottom perspective view of the twin action decapping pliers shown in FIG. 1;  
FIG. 4 is a bottom plan view of the twin action decapping pliers shown in FIG. 1;  
FIG. 5 is an end view of the twin action decapping pliers shown in FIG. 1;  
FIG. 6 is a side view of the twin action decapping pliers shown in FIG. 1;  
FIG. 7 is an end view of the end opposite that shown in FIG. 5;  
FIG. 8 is a side view of the side opposite that shown in FIG. 6; and,  
FIG. 9 is a top perspective view of the twin action decapping pliers shown in FIG. 1, in an “open” state.

**1 Claim, 7 Drawing Sheets**

- (56) **References Cited**  
U.S. PATENT DOCUMENTS  
3,817,126 A 6/1974 Koebbeman  
5,388,297 A 2/1995 Ross  
6,023,805 A 2/2000 Lin  
D483,634 S \* 12/2003 Jansson et al. .... D8/52  
D486,047 S \* 2/2004 Jansson et al. .... D8/52  
D605,012 S \* 12/2009 Robinson et al. .... D8/52  
7,845,255 B2\* 12/2010 Heinsohn ..... 81/416  
D637,054 S \* 5/2011 Schleiminger et al. .... D8/52  
7,992,466 B2\* 8/2011 Farrell ..... 81/9.4

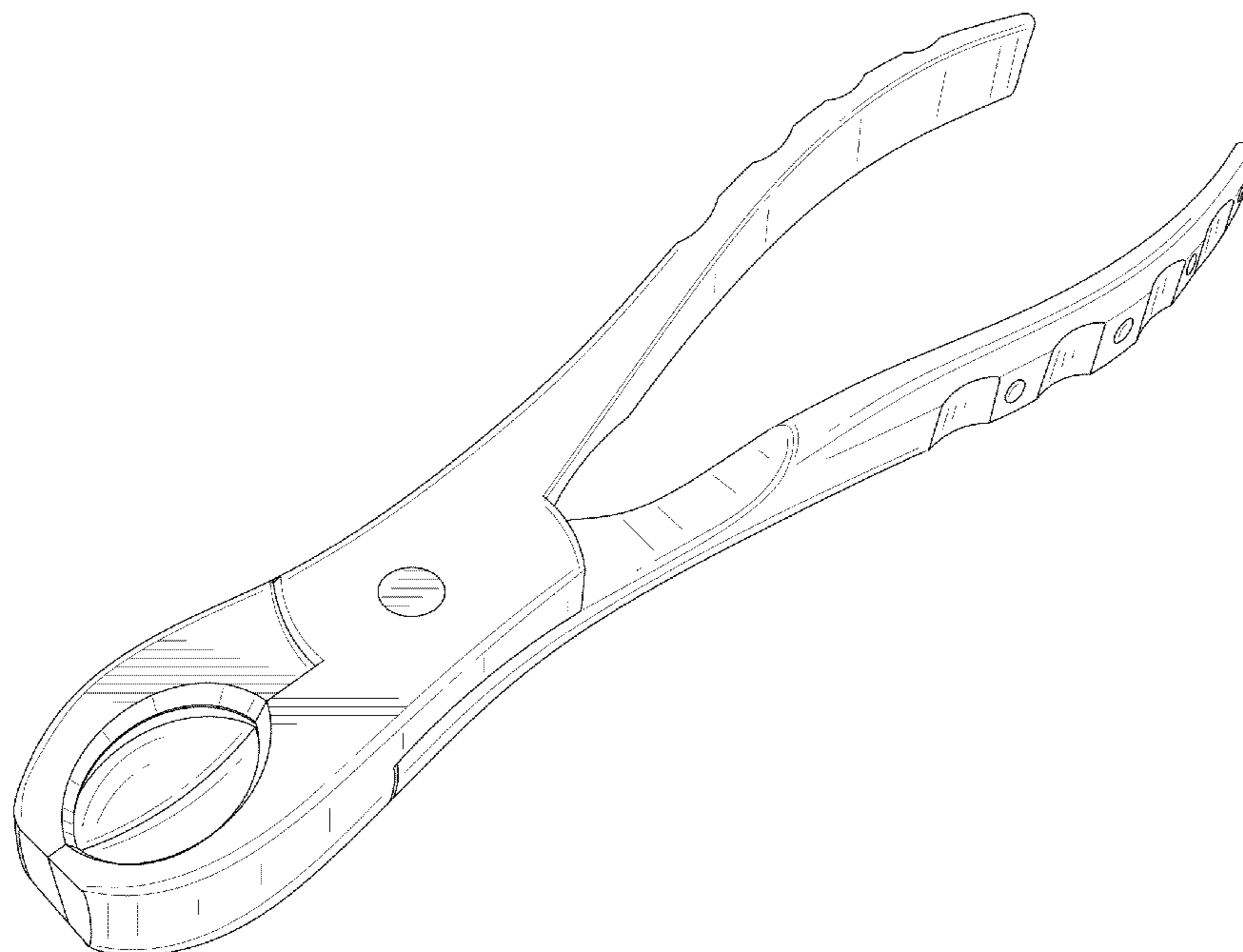

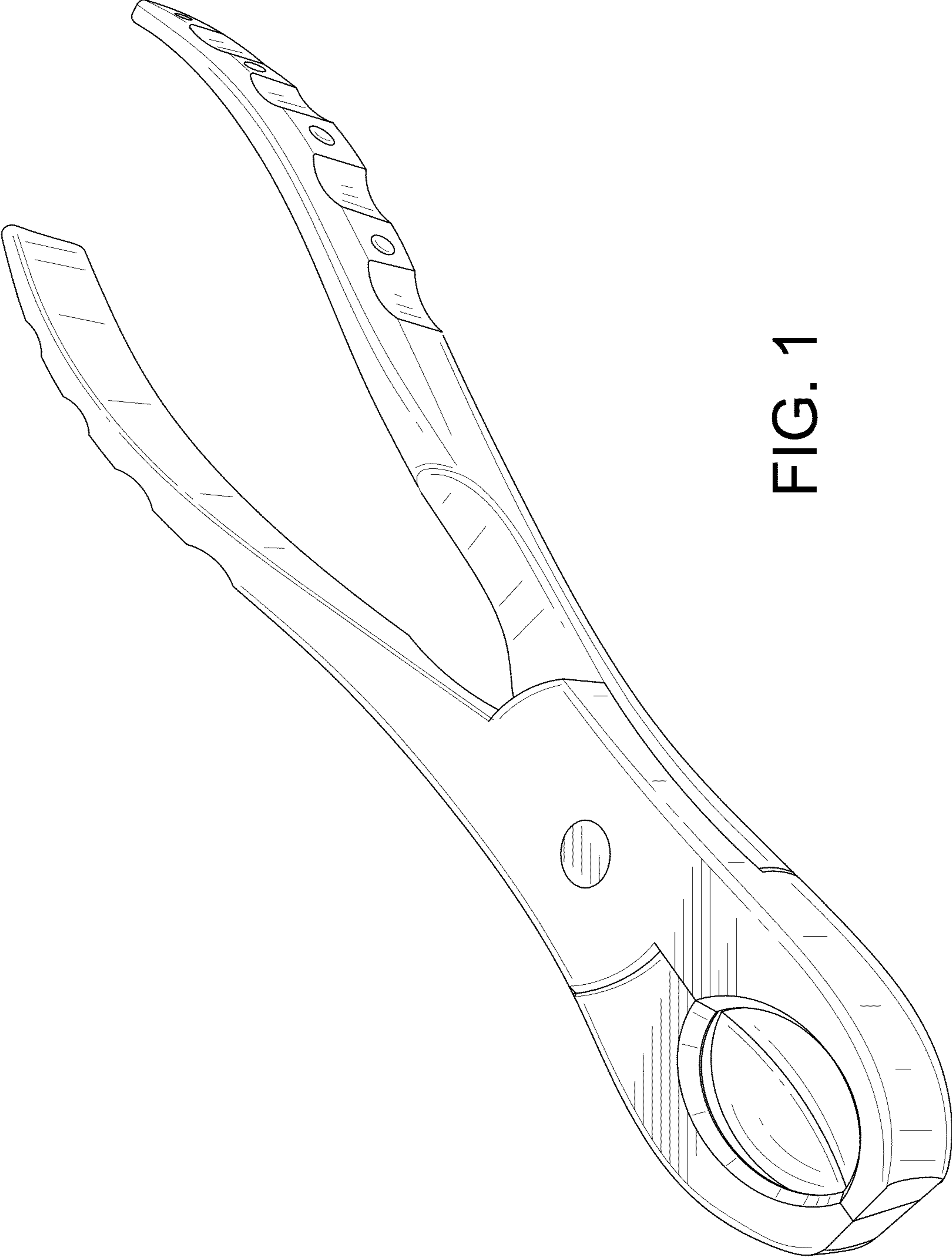

FIG. 1

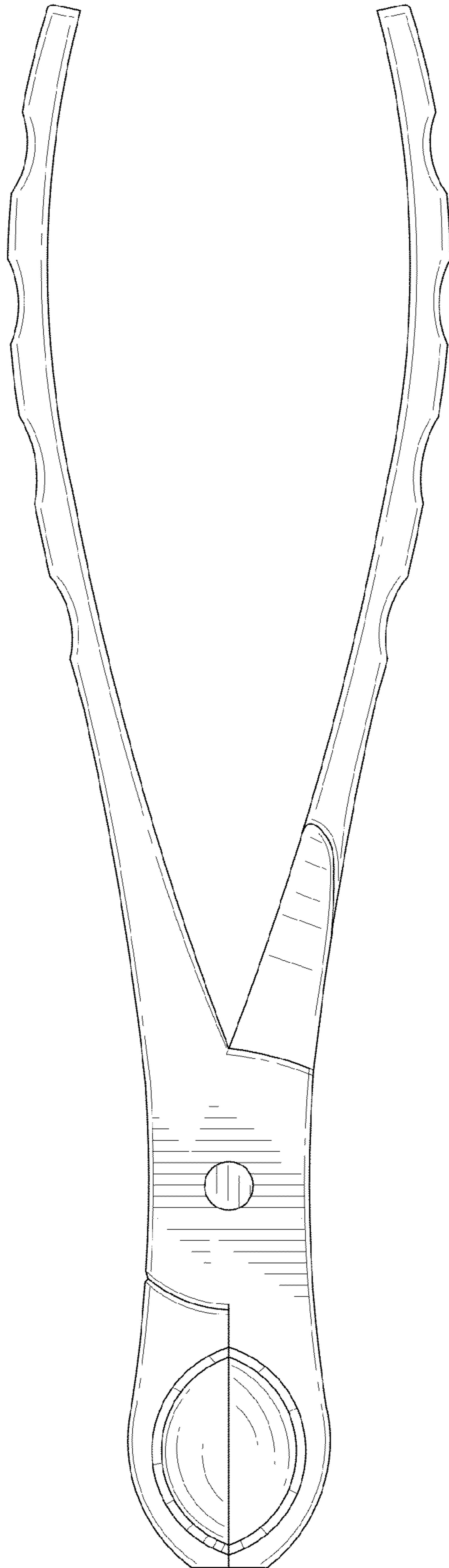

FIG. 2

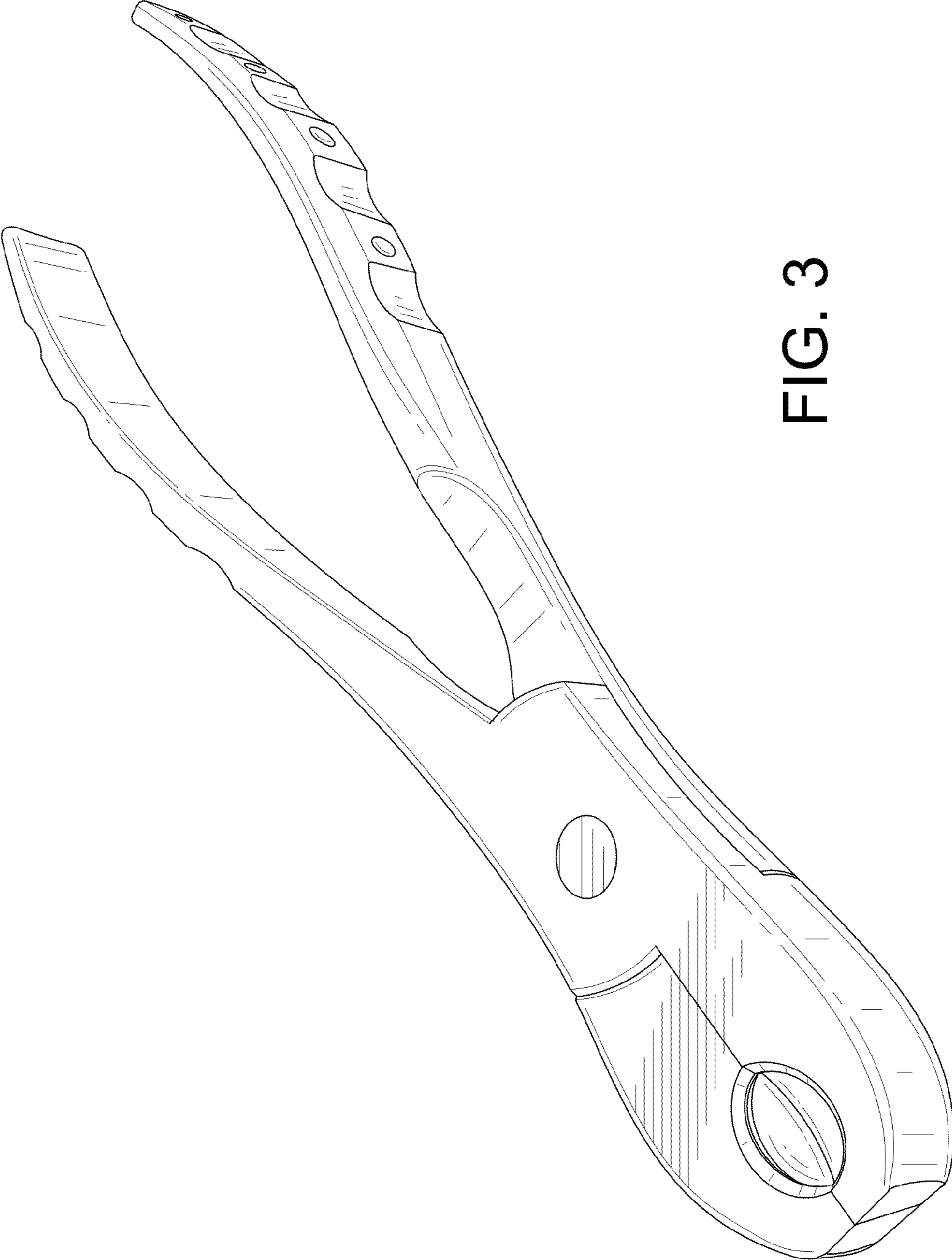

FIG. 3

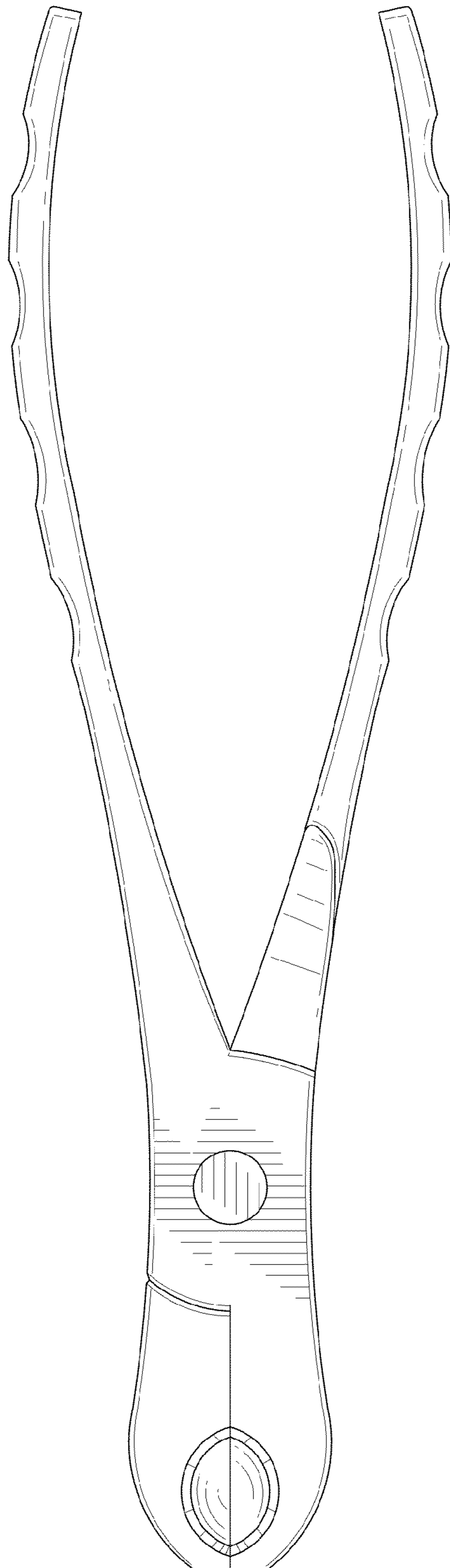

FIG. 4

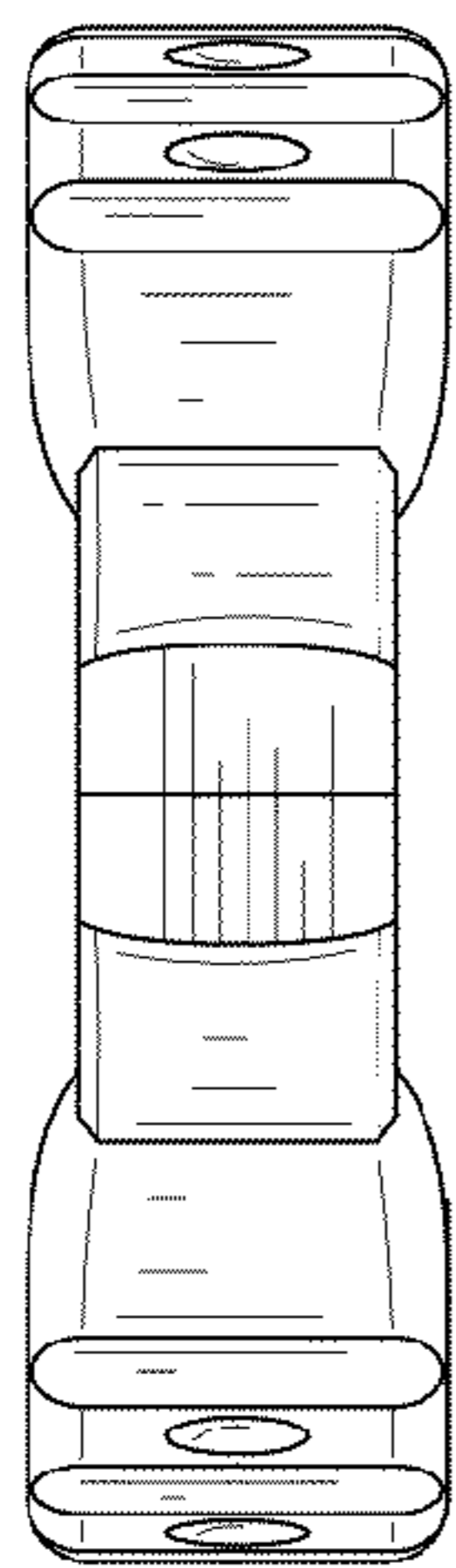

FIG. 5

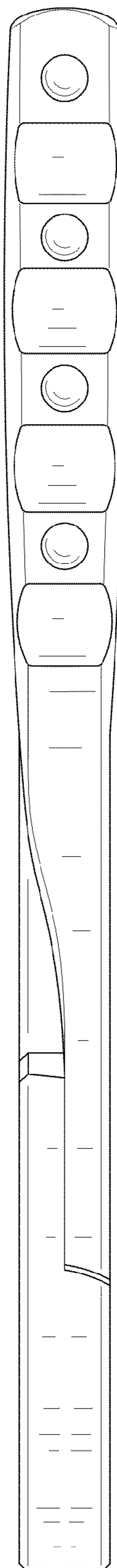

FIG. 6

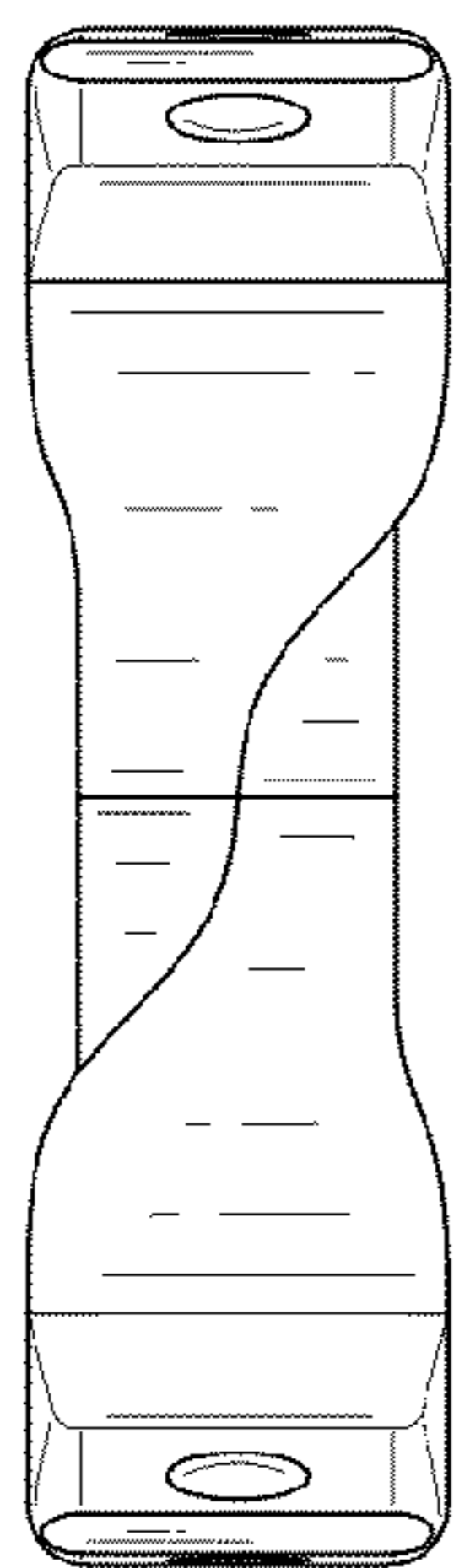

FIG. 7

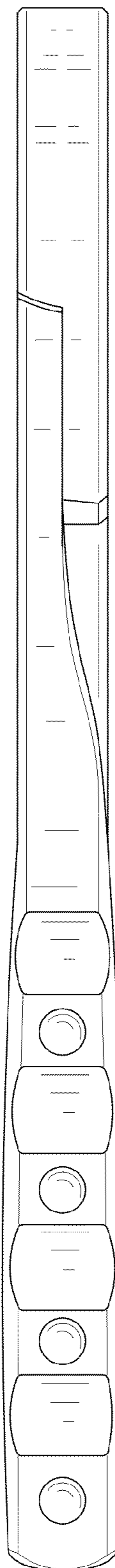

FIG. 8

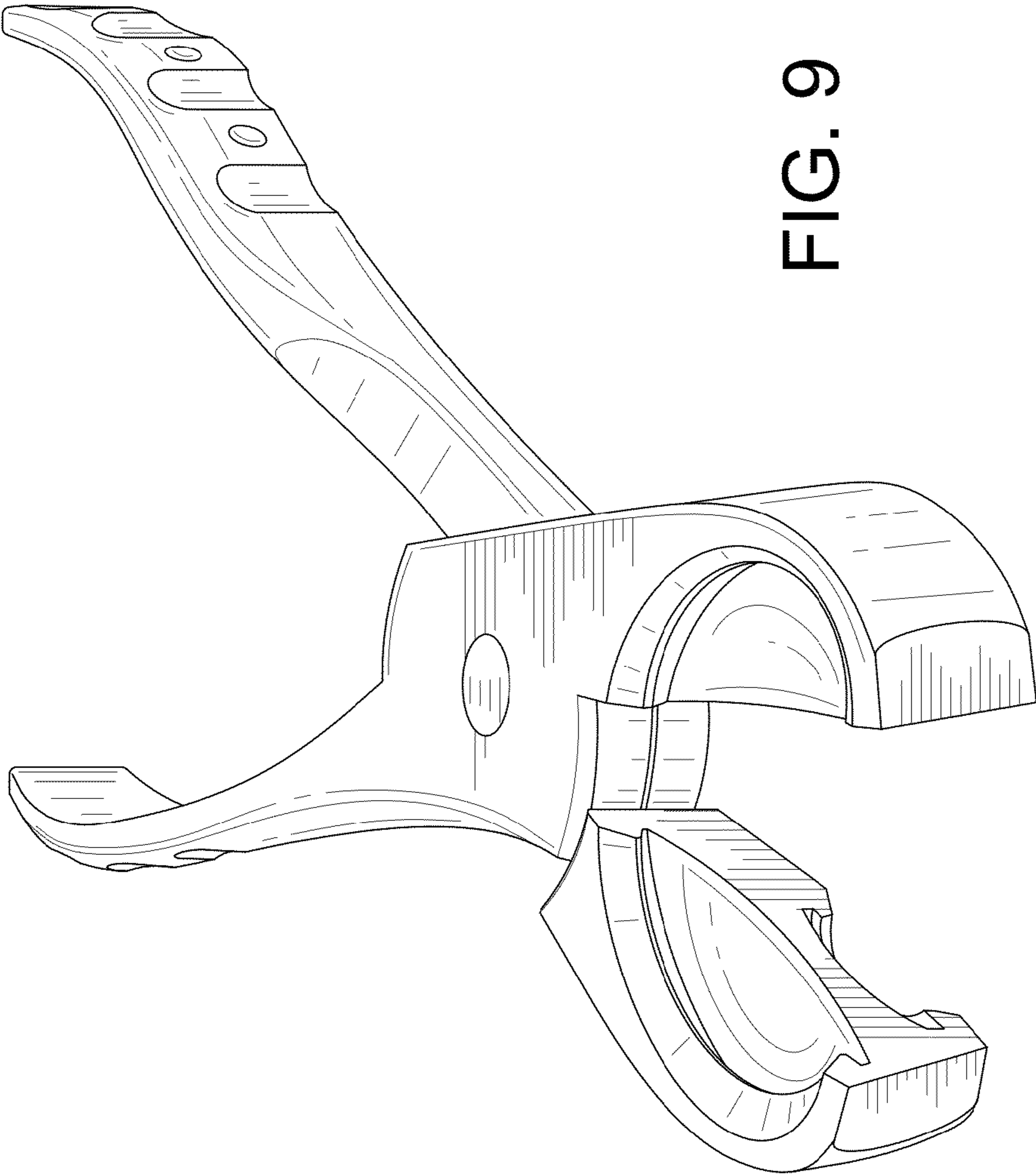

FIG. 9