



US00D715092S

(12) **United States Design Patent**
Thun et al.

(10) **Patent No.:** **US D715,092 S**
(45) **Date of Patent:** **** *Oct. 14, 2014**

(54) **POT**

(71) Applicant: **Zwilling J.A. Henckels AG**, Solingen (DE)

(72) Inventors: **Matteo Thun**, Mailand (IT); **Antonio Rodriguez**, Mailand (IT)

(73) Assignee: **Zwilling J.A. Henckels AG** (DE)

(*) Notice: This patent is subject to a terminal disclaimer.

(**) Term: **14 Years**

(21) Appl. No.: **29/489,053**

(22) Filed: **Apr. 25, 2014**

(51) **LOC (10) Cl.** **07-02**

(52) **U.S. Cl.**
USPC **D7/354**

(58) **Field of Classification Search**

CPC A47G 19/03; A47G 19/12; A47J 27/00; A47J 27/002; A47J 27/08; A47J 27/21; A47J 27/58; A47J 36/025; A47J 36/06; A47J 36/12; A47J 37/00; A47J 37/10; A47J 37/101; A47J 37/103; A47J 37/12; A47J 37/1204; A47J 45/061; A47J 45/071; A47J 45/08; H05B 6/12
USPC D7/354-363, 391, 393-396, 396.1, 409, D7/540, 565, 586, 602, 323; D9/429, 500, D9/776; 99/331, 339-340, 403, 425-426, 99/444-445, 324; 126/373.1, 126/383.1-384.1, 390.1; 219/438-439, 219/620-622; 220/573.1-573.5, 752-753, 220/755-759, 912; 222/465.1, 470, 475.1; 229/407

See application file for complete search history.

(56) **References Cited**

U.S. PATENT DOCUMENTS

D199,747 S 12/1964 Farber
D221,979 S 9/1971 Madl
D230,690 S 3/1974 Aries
D252,373 S 7/1979 Eisenrod
D254,117 S 2/1980 Kramer
D255,970 S 7/1980 Lackmann
D264,540 S 5/1982 Otake
D265,161 S 6/1982 Otake
D267,388 S 12/1982 Spoeth, Jr. et al.
D269,243 S 6/1983 Lam
D269,399 S 6/1983 Lam
D328,996 S 9/1992 Gerlach

(Continued)

Primary Examiner — Ricky Pham

(74) *Attorney, Agent, or Firm* — Mayback & Hoffman, P.A.; Gregory L. Mayback

(57) **CLAIM**

The ornamental design for a pot, as shown and described.

DESCRIPTION

FIG. 1 is a perspective view of a pot showing our new design; FIG. 2 is an elevational view of a front side of the pot of FIG. 1; FIG. 3 is an elevational view of a rear side of the pot of FIG. 1 from a side opposite the view of FIG. 2; FIG. 4 is an elevational view of a right side of the pot of FIG. 1; FIG. 5 is an elevational view of a left side of the pot of FIG. 1 from a side opposite the view of FIG. 4; FIG. 6 is a top plan view of the pot of FIG. 1; and, FIG. 7 is a bottom plan view of the pot of FIG. 1. The dashed lines indicating holes are for the purpose of illustrating unclaimed environment of the design, are for illustrative purposes only, and form no part of the claimed design.

1 Claim, 7 Drawing Sheets

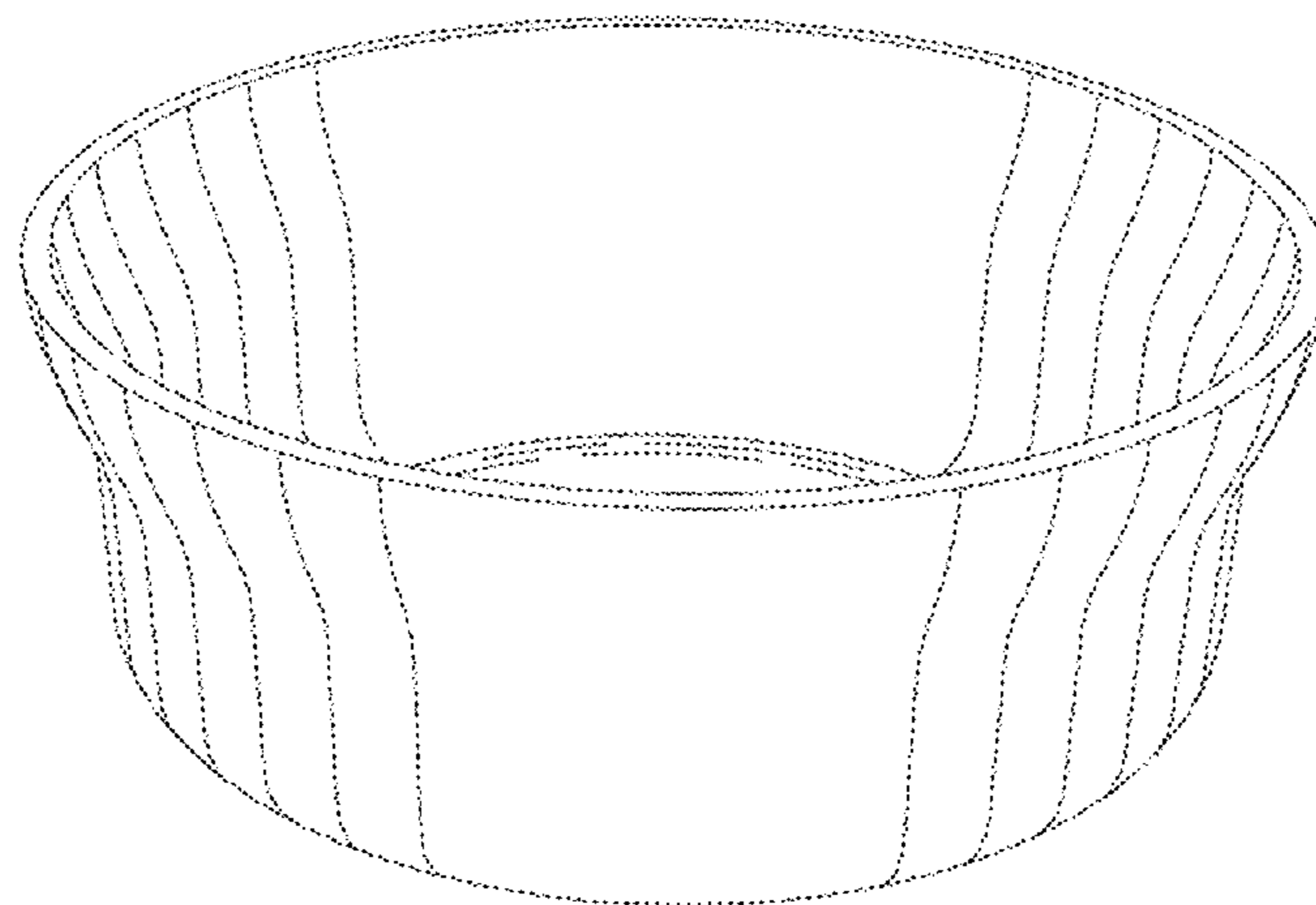

(56)

References Cited

U.S. PATENT DOCUMENTS

D341,058 S	11/1993	Slany et al.	
D358,062 S	5/1995	Hasuike	
D368,828 S	4/1996	Thurlow	
D370,827 S	6/1996	Combe	
D371,933 S	7/1996	Ito	
D374,373 S	10/1996	Ito	
D414,375 S	9/1999	Diulus	
D437,174 S	2/2001	Inoue	
D460,663 S *	7/2002	Seager	D7/565
D469,301 S	1/2003	Ryan et al.	
D469,315 S *	1/2003	Thonis et al.	D7/602
D482,562 S	11/2003	Demers	
D544,298 S *	6/2007	Eide et al.	D7/396.1
D544,307 S *	6/2007	Ablo	D7/540
D546,672 S *	7/2007	Chou	D9/429
D551,909 S *	10/2007	Eide et al.	D7/565
D568,667 S	5/2008	Appleton	
D569,684 S *	5/2008	Eide et al.	D7/396.1
D579,716 S	11/2008	Pawson et al.	
D587,065 S *	2/2009	Loring	D7/391
D599,164 S	9/2009	Hoekstra	
D599,609 S	9/2009	Ruffoni	
D600,971 S	9/2009	Garpelin	
D603,218 S	11/2009	Hollinger	
D653,124 S *	1/2012	Diss	D9/776
D688,917 S *	9/2013	Ludeman et al.	D7/586
D689,335 S *	9/2013	Ludeman et al.	D7/586
D697,801 S *	1/2014	Rapparini	D9/500
2002/0113118 A1 *	8/2002	Littlejohn et al.	229/407

* cited by examiner

FIG. 1

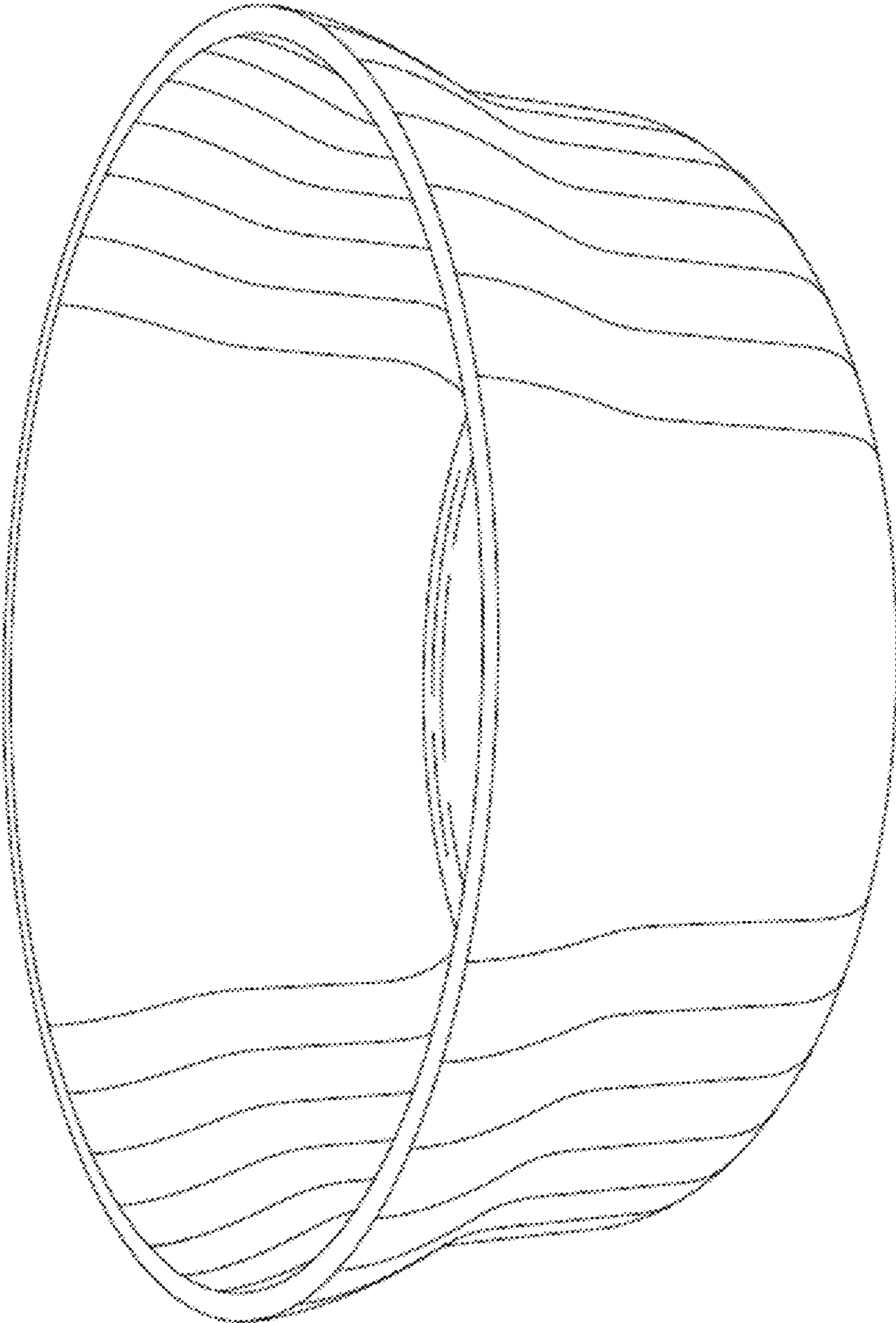

FIG. 2

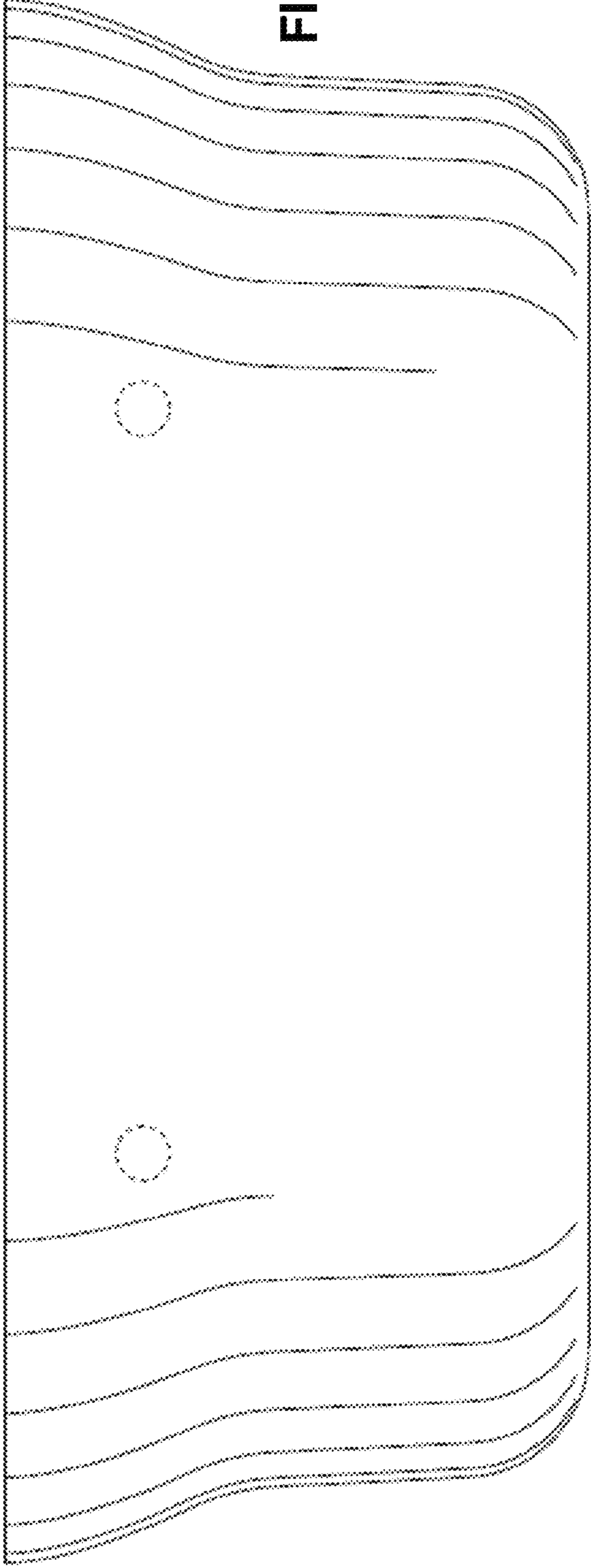

FIG. 3



FIG. 4

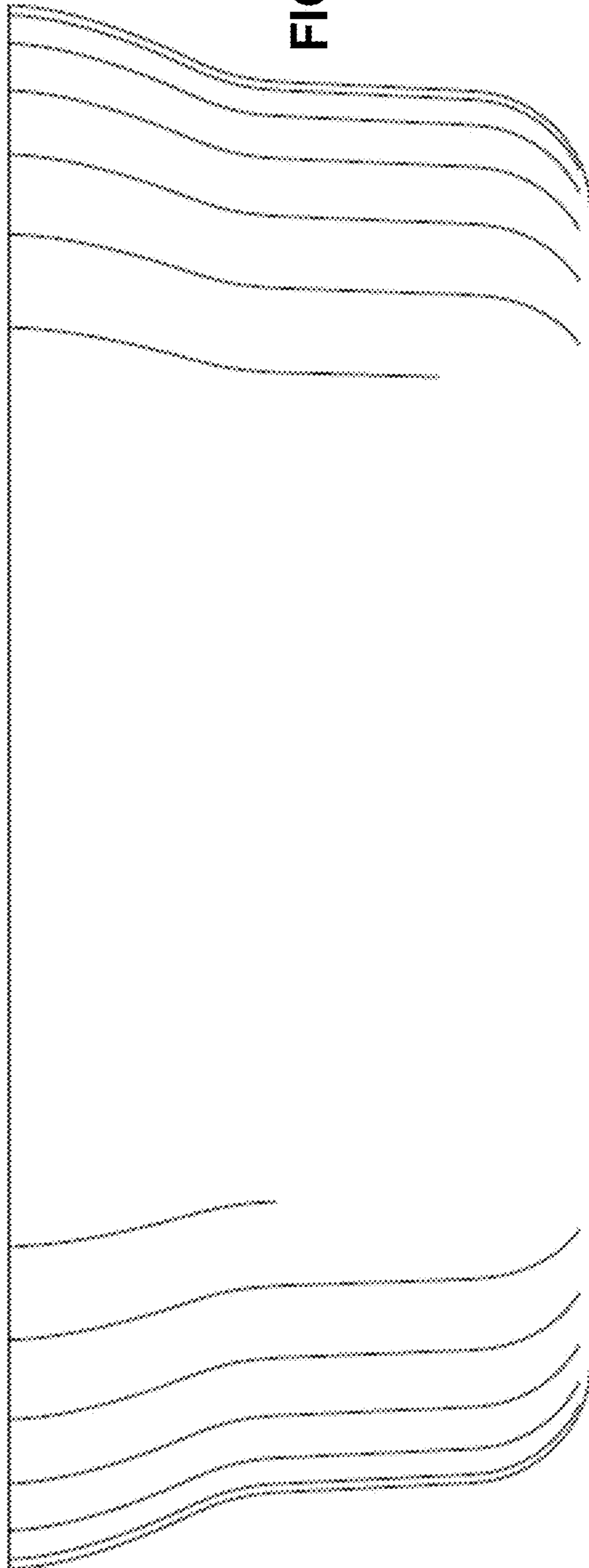

FIG. 5

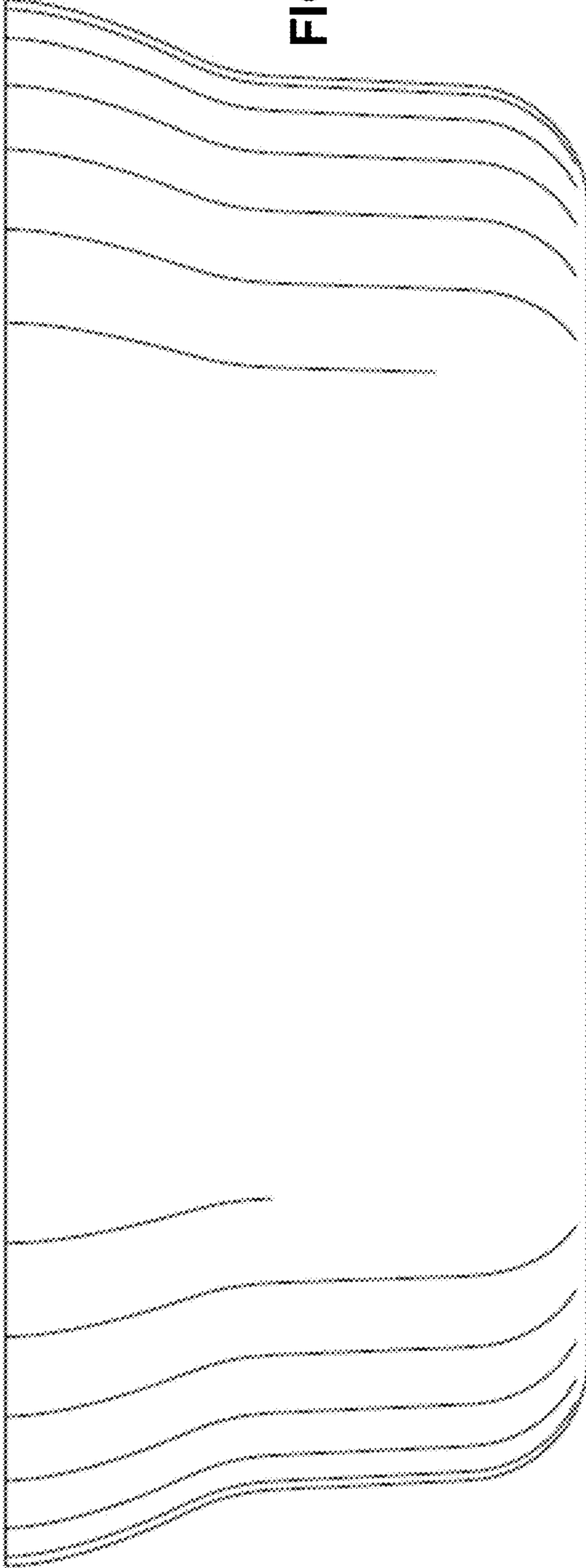

FIG. 6

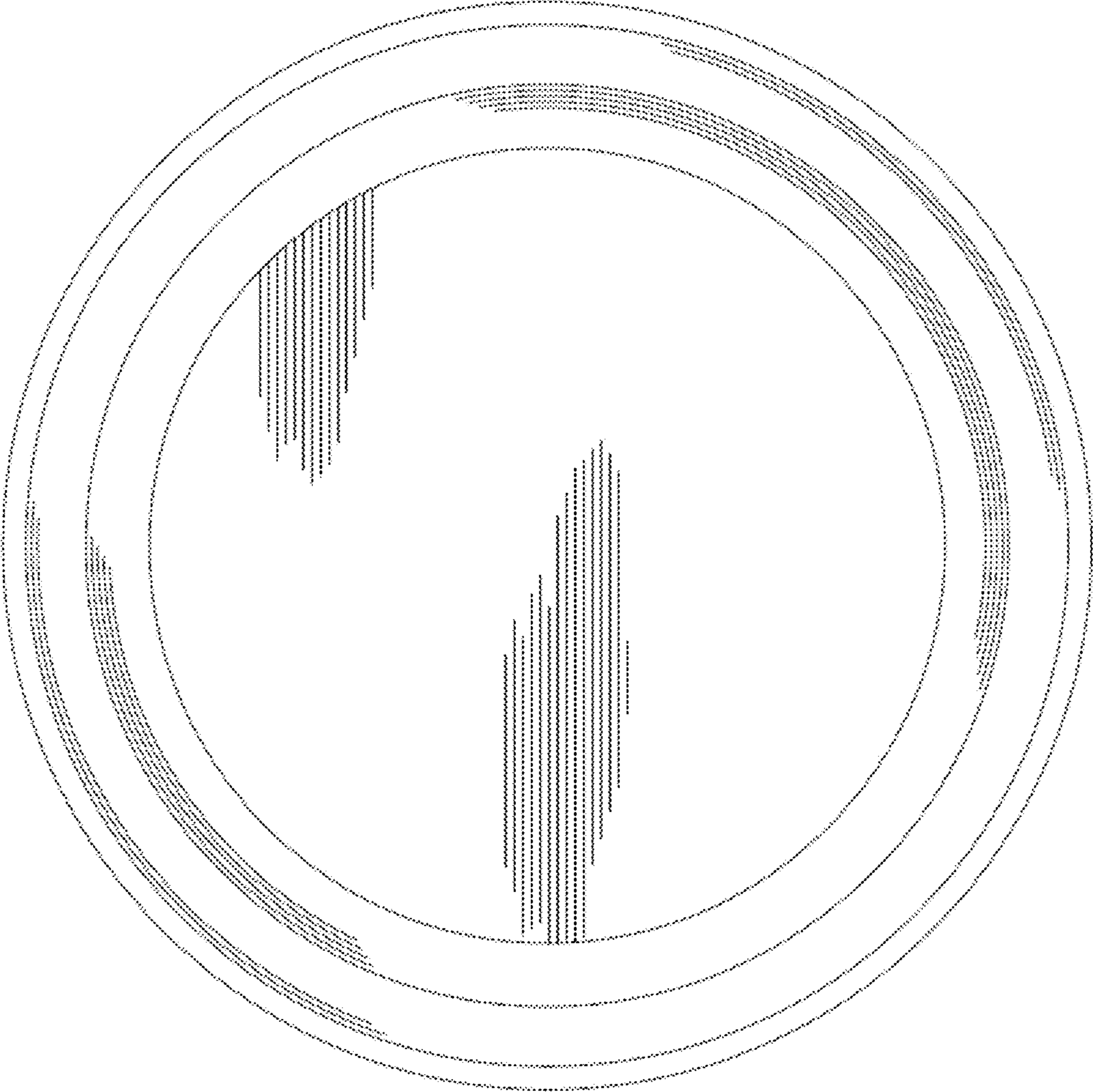
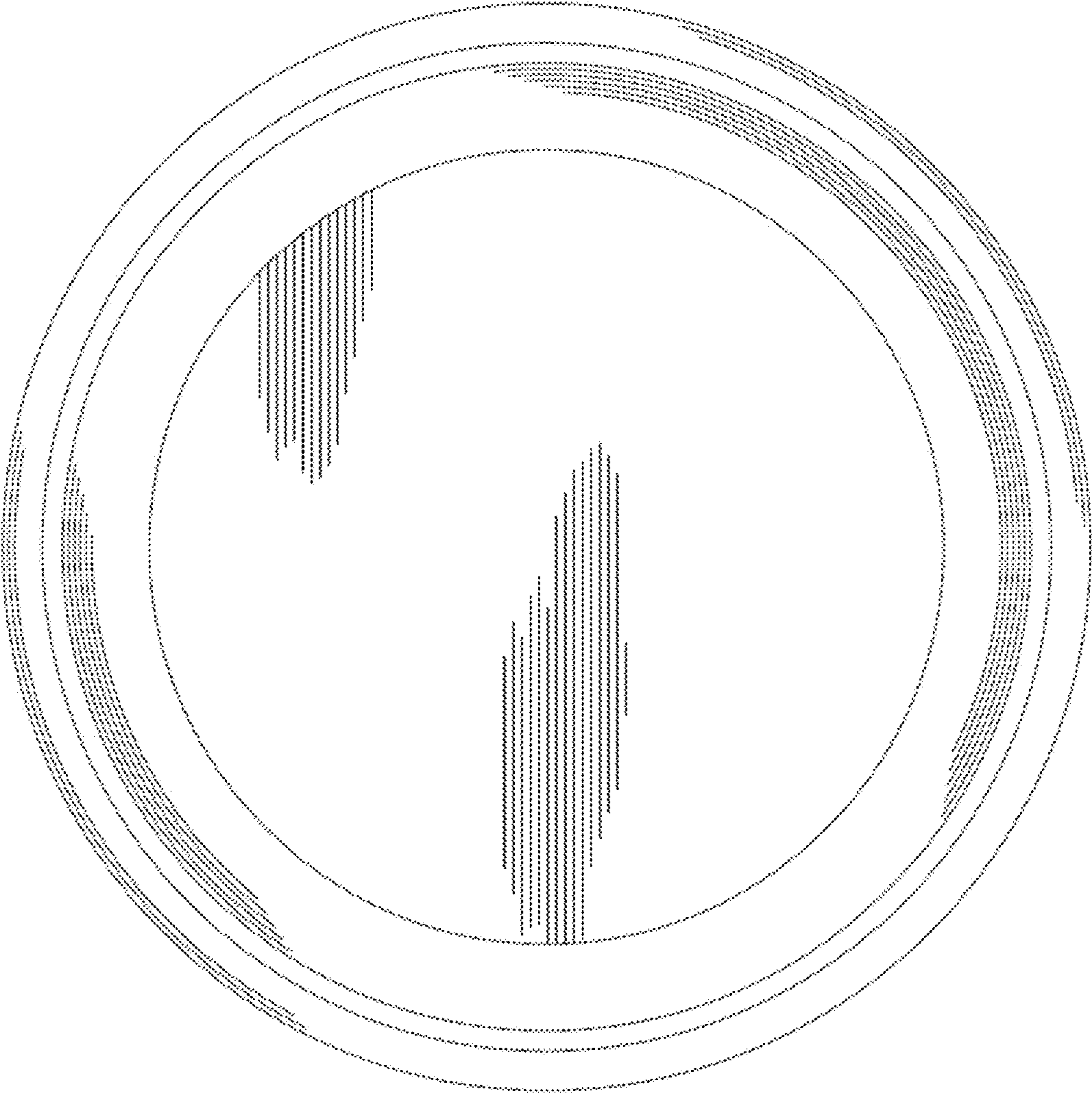

FIG. 7



UNITED STATES PATENT AND TRADEMARK OFFICE
CERTIFICATE OF CORRECTION

PATENT NO. : D715,092 S
APPLICATION NO. : 29/489053
DATED : October 14, 2014
INVENTOR(S) : Matteo Thun and Antonio Rodriguez

Page 1 of 9

It is certified that error appears in the above-identified patent and that said Letters Patent is hereby corrected as shown below:

The Title page, showing the illustrative figure, should be deleted and substitute therefor the attached Title page.

In the Drawings

Delete drawings sheets 1-7 and substitute therefor the drawing sheets, consisting of figs. 1-7 as shown on the attached page.

Signed and Sealed this
Twenty-first Day of July, 2015



Michelle K. Lee
Director of the United States Patent and Trademark Office

(12) **United States Design Patent** (10) Patent No.: **US D715,092 S**
Thun et al. (45) Date of Patent: **** *Oct. 14, 2014**

(54) POT

(71) Applicant: **Zwilling J.A. Henckels AG, Solingen (DE)**

(72) Inventors: **Matteo Thun, Mailand (IT); Antonio Rodriguez, Mailand (IT)**

(73) Assignee: **Zwilling J.A. Henckels AG (DE)**

(*) Notice: **This patent is subject to a terminal disclaimer.**

(**) Term: **14 Years**

(21) Appl. No.: **29/489,053**

(22) Filed: **Apr. 25, 2014**

(51) LOC (10) Cl. **07-02**

(52) U.S. Cl.
 USPC **D7/354**

(58) **Field of Classification Search**

CPC **A47G 19/03; A47G 19/12; A47J 27/00; A47J 27/002; A47J 27/08; A47J 27/21; A47J 27/58; A47J 36/025; A47J 36/06; A47J 36/12; A47J 37/00; A47J 37/10; A47J 37/101; A47J 37/103; A47J 37/12; A47J 37/1204; A47J 45/061; A47J 45/071; A47J 45/08; H05B 6/12**
 USPC **D7/354-363, 391, 393-396, 396.1, 409, D7/540, 565, 586, 602, 323; D9/429, 500, D9/776; 99/331, 339-340, 403, 425-426, 99/444-445, 324; 126/373.1, 126/383.1-384.1, 390.1; 219/438-439, 219/620-622; 220/573.1-573.5, 752-753, 220/755-759, 912; 222/465.1, 470, 475.1; 229/407**

See application file for complete search history.

(56)

References Cited

U.S. PATENT DOCUMENTS

D199,747 S	12/1964	Farber
D221,979 S	9/1971	Madi
D230,690 S	3/1974	Aries
D252,373 S	7/1979	Eisenrod
D254,117 S	2/1980	Kramer
D255,970 S	7/1980	Lackmann
D264,540 S	5/1982	Otake
D265,161 S	6/1982	Otake
D267,388 S	12/1982	Spoeth, Jr. et al.
D269,243 S	6/1983	Lam
D269,399 S	6/1983	Lam
D328,996 S	9/1992	Gerlach

(Continued)

Primary Examiner **Ricky Pham**

(74) *Attorney, Agent, or Firm* **Mayback & Hoffman, P.A.; Gregory L. Mayback**

(57)

CLAIM

The ornamental design for a pot, as shown and described.

DESCRIPTION

FIG. 1 is a perspective view of a pot showing our new design; FIG. 2 is an elevational view of a front side of the pot of FIG. 1; FIG. 3 is an elevational view of a rear side of the pot of FIG. 1 from a side opposite the view of FIG. 2; FIG. 4 is an elevational view of a right side of the pot of FIG. 1; FIG. 5 is an elevational view of a left side of the pot of FIG. 1 from a side opposite the view of FIG. 4; FIG. 6 is a top plan view of the pot of FIG. 1; and FIG. 7 is a bottom plan view of the pot of FIG. 1. The dashed lines indicating holes are for the purpose of illustrating unclaimed environment of the design, are for illustrative purposes only, and form no part of the claimed design.

1 Claim, 7 Drawing Sheets

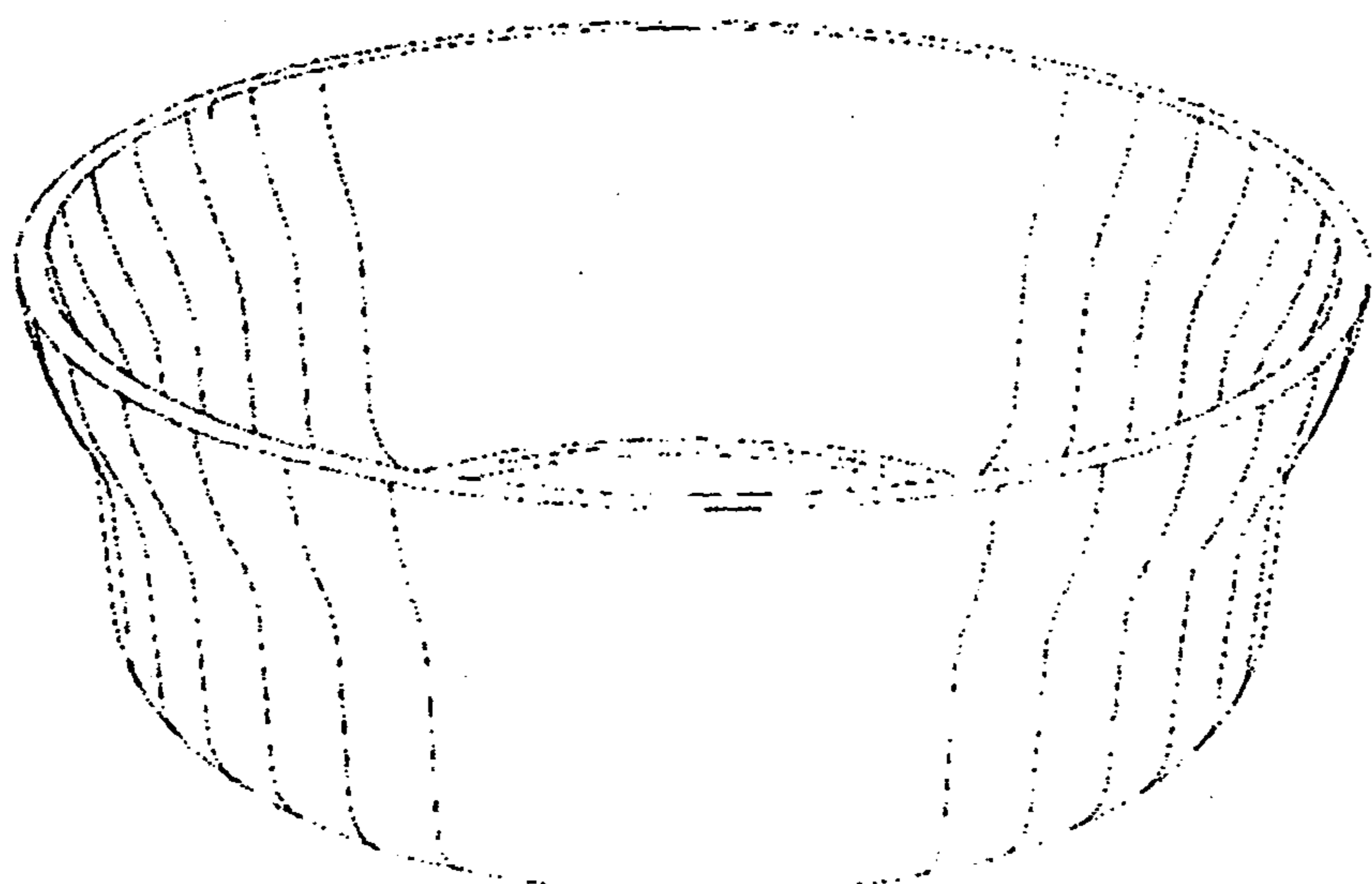

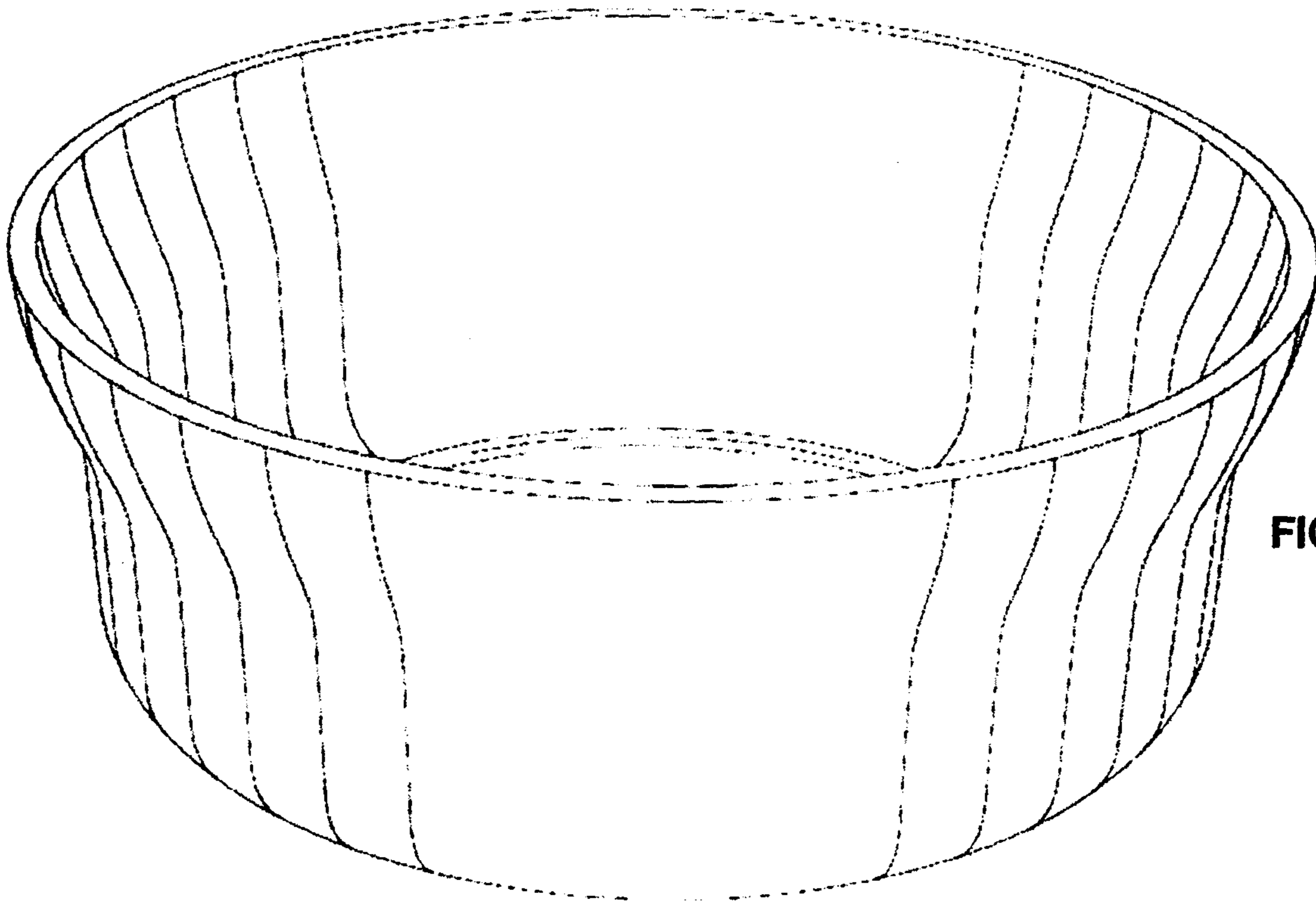

FIG. 1

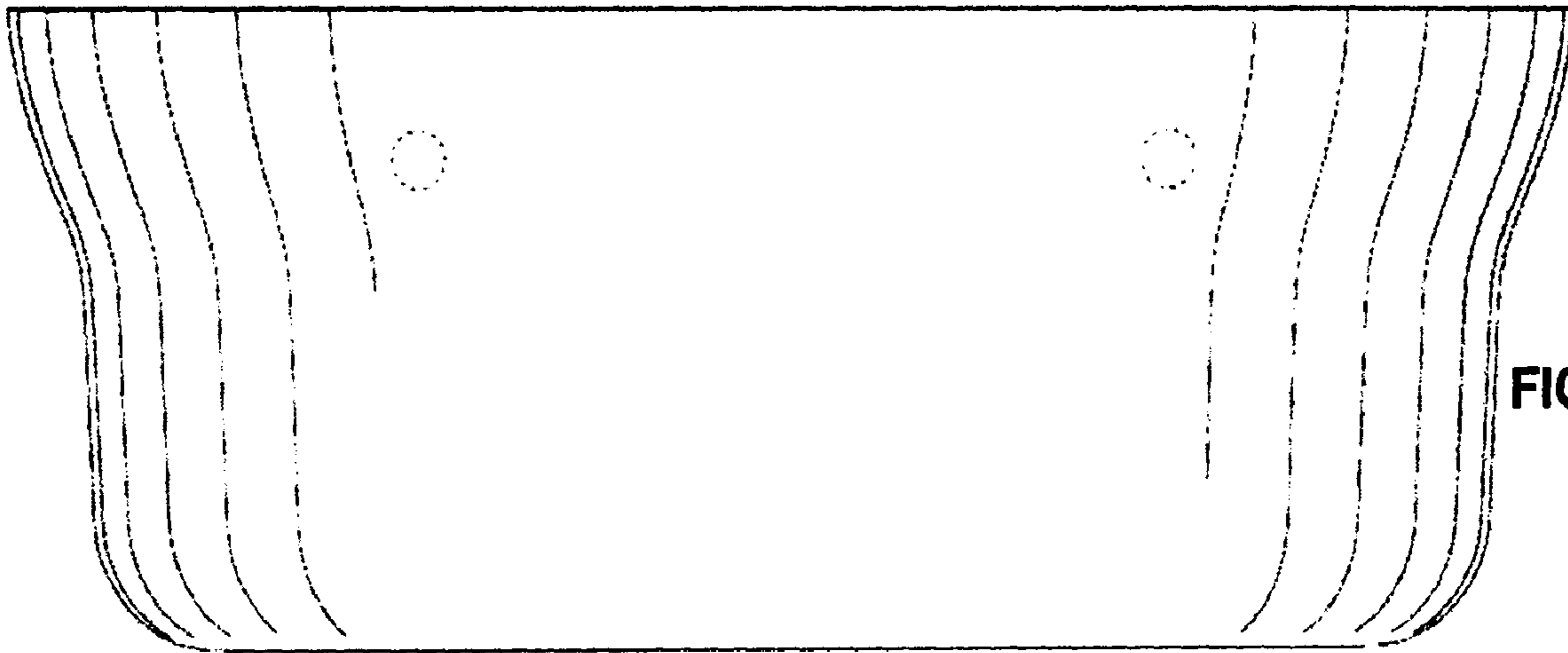

FIG. 2

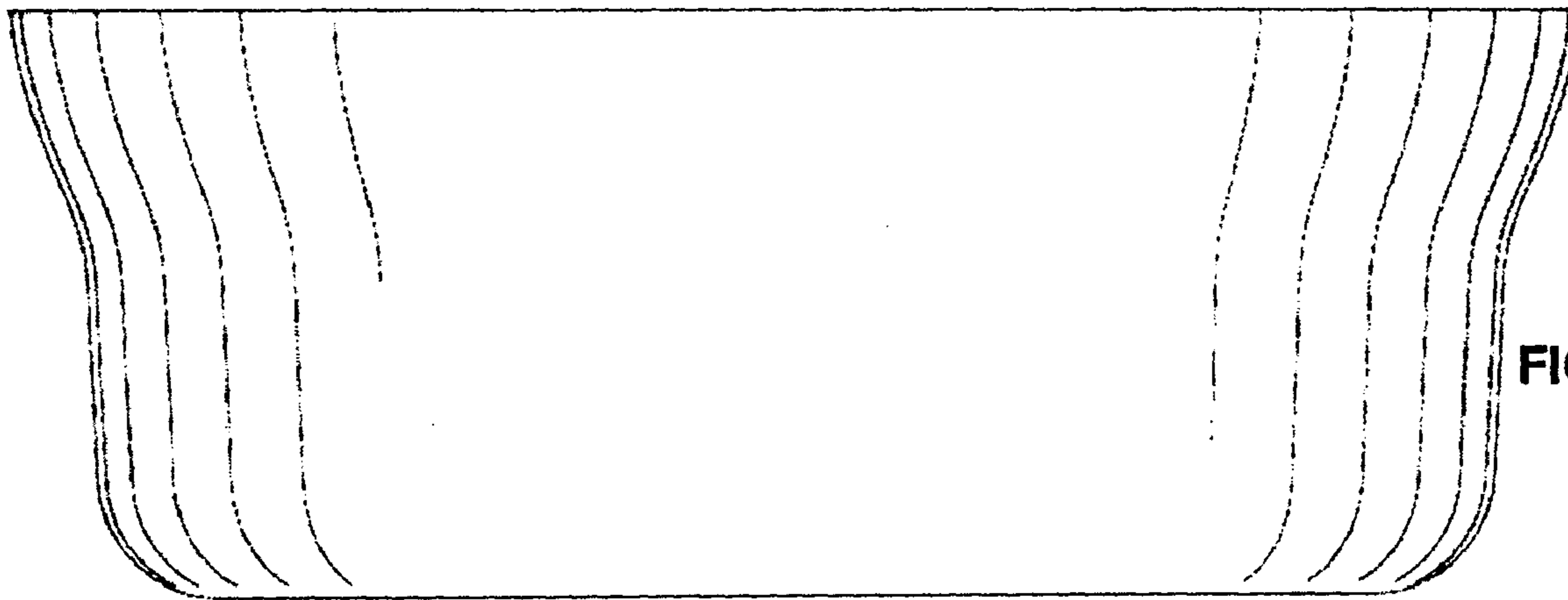

FIG. 3

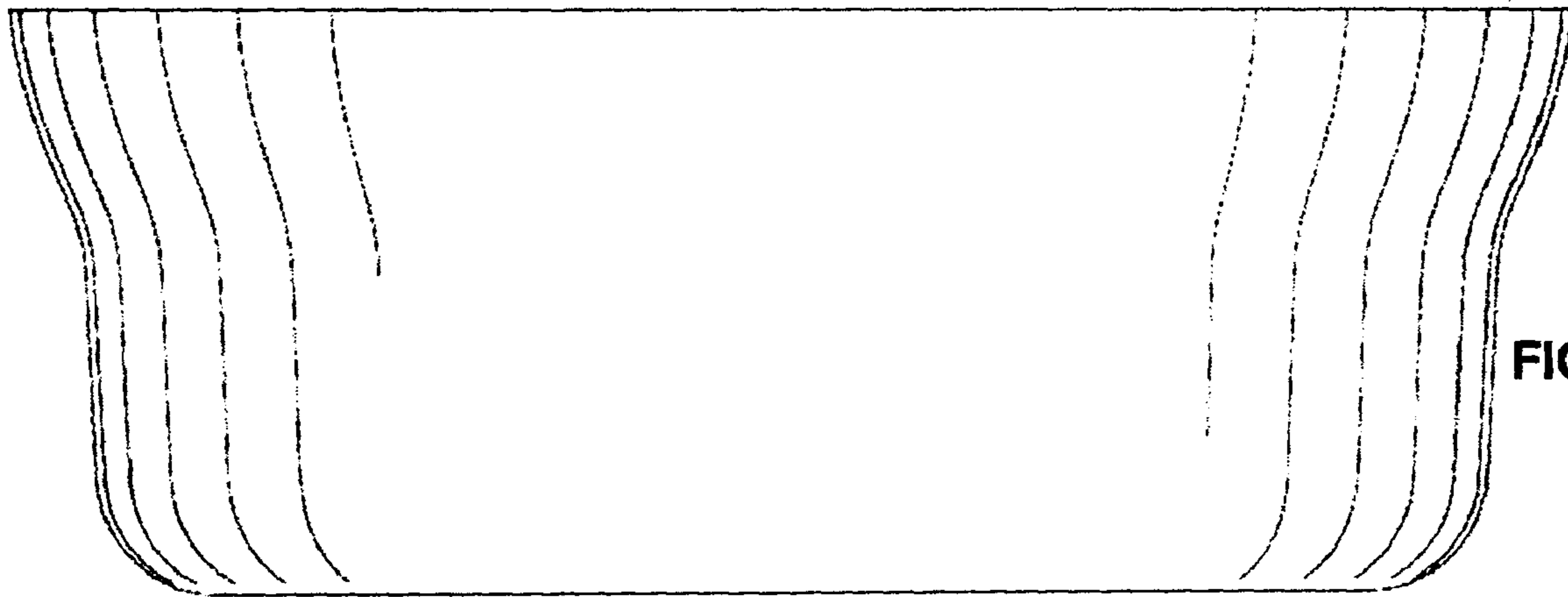

FIG. 4

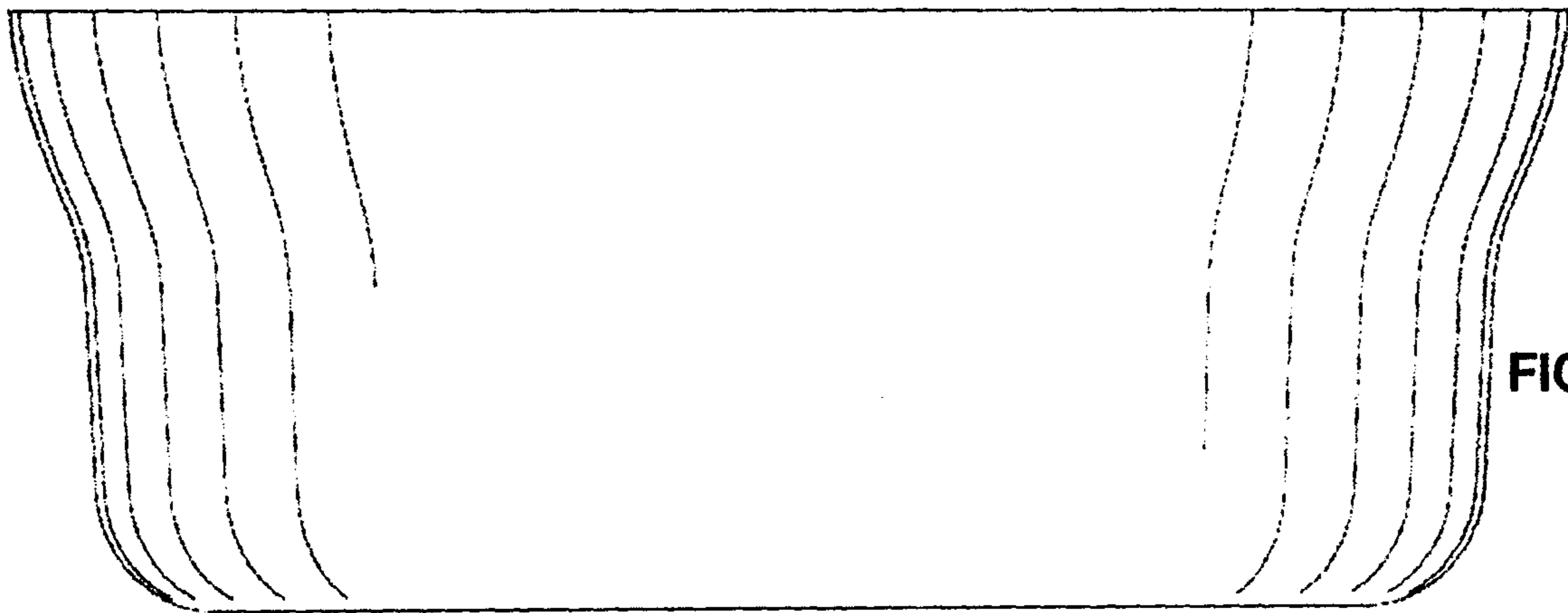

FIG. 5



FIG. 6



FIG. 7