



US00D714944S

(12) **United States Design Patent**  
**Gerber et al.**

(10) **Patent No.:** **US D714,944 S**  
(45) **Date of Patent:** **\*\* Oct. 7, 2014**

- (54) **PORTABLE DIALYSIS CABINET**
- (71) Applicant: **Medtronic, Inc.**, Minneapolis, MN (US)
- (72) Inventors: **Martin T. Gerber**, Maple Grove, MN (US); **David B. Lura**, Maple Grove, MN (US); **Bryant J. Pudil**, Plymouth, MN (US); **Thomas E. Meyer**, Stillwater, MN (US); **Brian Mullins**, Minneapolis, MN (US)
- (73) Assignee: **Medtronic, Inc.**, Minneapolis, MN (US)
- (\*\*) Term: **14 Years**
- (21) Appl. No.: **29/446,276**
- (22) Filed: **Feb. 21, 2013**

**Related U.S. Application Data**

- (63) Continuation-in-part of application No. 13/757,693, filed on Feb. 1, 2013, and a continuation-in-part of application No. 13/757,709, filed on Feb. 1, 2013, and a continuation-in-part of application No. 13/757,717, filed on Feb. 1, 2013, and a continuation-in-part of application No. 13/757,722, filed on Feb. 1, 2013, and a continuation-in-part of application No. 13/757,728, filed on Feb. 1, 2013.
- (51) **LOC (10) Cl.** ..... **24-00**
- (52) **U.S. Cl.**  
USPC ..... **D24/185**
- (58) **Field of Classification Search**  
USPC ..... D24/185, 186, 144, 160, 167-169, 172, D24/200, 158, 164; D34/12, 14; 312/22, 312/109, 209, 223.1, 286, 249.8, 249.12; 248/282.1; 600/437, 443, 459  
See application file for complete search history.

(56) **References Cited**

**U.S. PATENT DOCUMENTS**

- D86,687 S \* 4/1932 Prouty ..... D24/185
- D101,605 S \* 10/1936 Anderson ..... D24/200

(Continued)

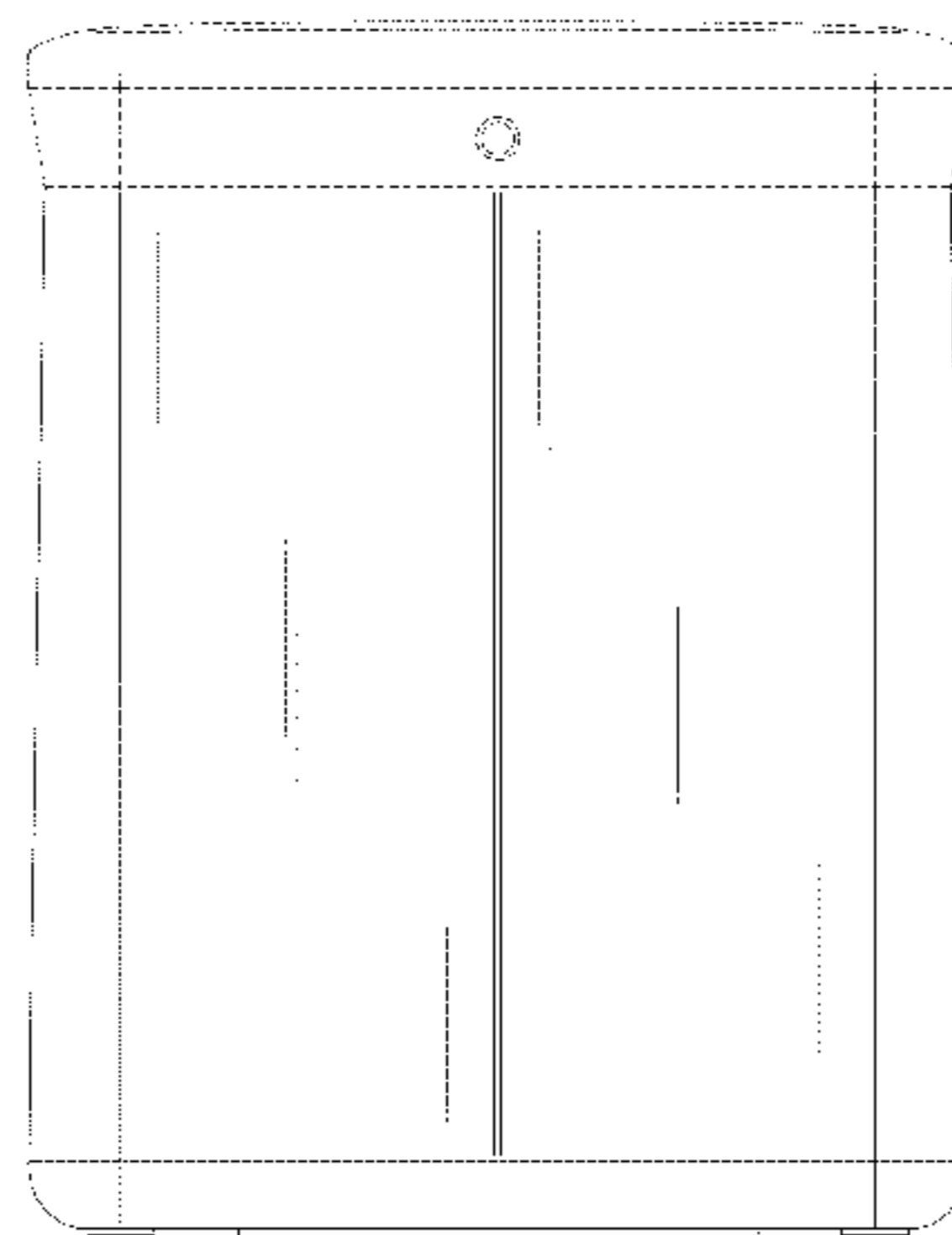
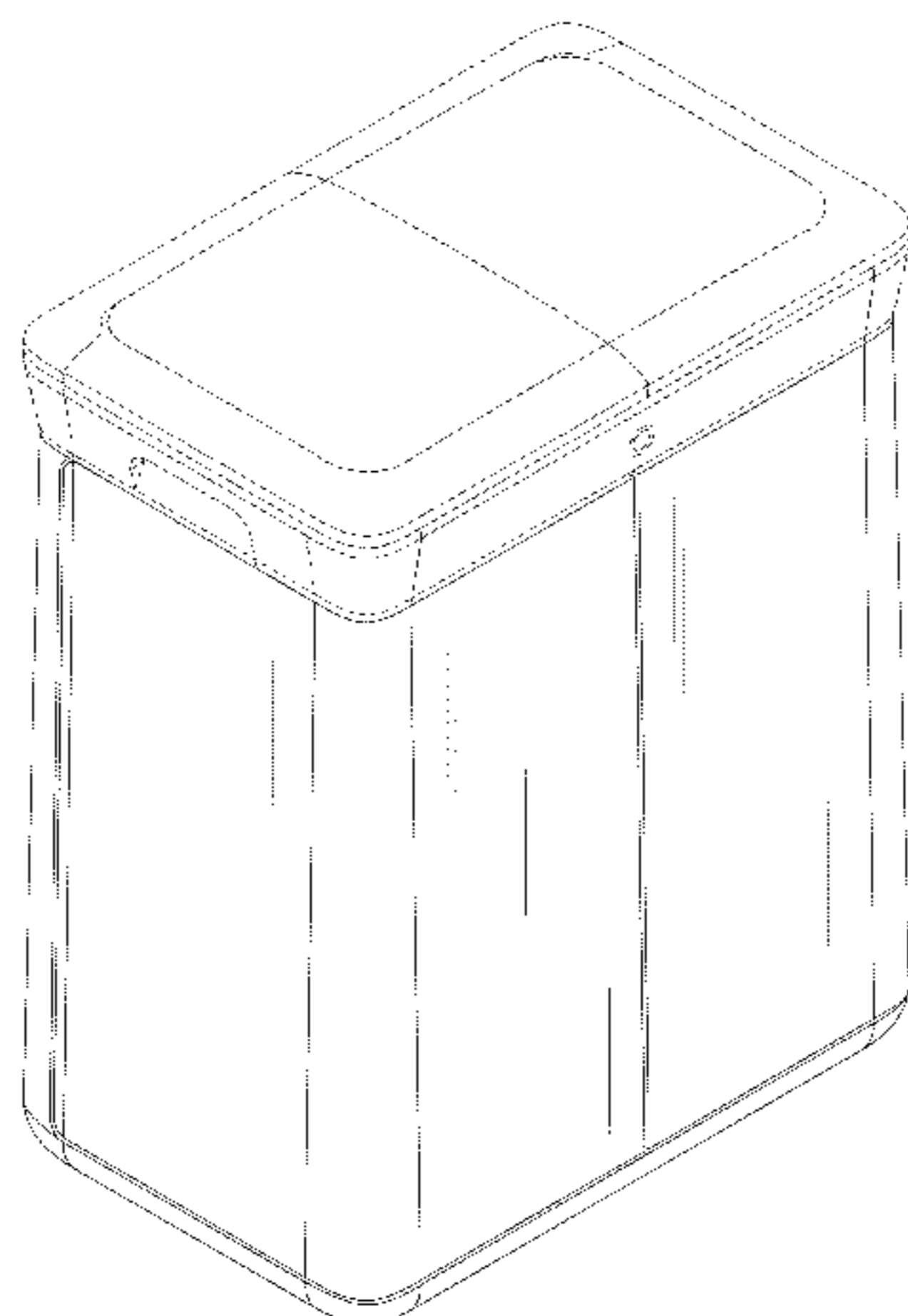
*Primary Examiner* — Ian Simmons  
*Assistant Examiner* — Rhea Shields  
(74) *Attorney, Agent, or Firm* — Hahn & Voight PLLC; Roger C. Hahn

(57) **CLAIM**  
We claim the ornamental design for a portable dialysis cabinet, as shown and described.

**DESCRIPTION**

FIG. 1 is a perspective view of a portable dialysis cabinet according to one embodiment;  
 FIG. 2 is a front view of the portable dialysis cabinet referenced in FIG. 1;  
 FIG. 3 is a rear view of the portable dialysis cabinet referenced in FIG. 1;  
 FIG. 4 is a left side view of the portable dialysis cabinet referenced in FIG. 1;  
 FIG. 5 is a right side view of the portable dialysis cabinet referenced in FIG. 1;  
 FIG. 6 is a top view of the portable dialysis cabinet referenced in FIG. 1;  
 FIG. 7 is a bottom view of the portable dialysis cabinet referenced in FIG. 1;  
 FIG. 8 is a perspective view of a portable dialysis cabinet according to another embodiment;  
 FIG. 9 is a front view of the portable dialysis cabinet referenced in FIG. 8;  
 FIG. 10 is a rear view of the portable dialysis cabinet referenced in FIG. 8;  
 FIG. 11 is a left side view of the portable dialysis cabinet referenced in FIG. 8;  
 FIG. 12 is a right side view of the portable dialysis cabinet referenced in FIG. 8;  
 FIG. 13 is a top view of the portable dialysis cabinet referenced in FIG. 8; and  
 FIG. 14 is a bottom view of the portable dialysis cabinet referenced in FIG. 8.  
 In the drawings, the broken lines depict environmental subject matter only and form no part of the claimed design.

**1 Claim, 14 Drawing Sheets**



(56)

**References Cited**

U.S. PATENT DOCUMENTS

D263,573 S \* 3/1982 Ingledew ..... D34/14  
D273,717 S \* 5/1984 McCombs ..... D24/164  
D319,308 S \* 8/1991 Royse et al. .... D24/185  
5,113,546 A \* 5/1992 Parent ..... 15/315  
D332,855 S \* 1/1993 Royse et al. .... D34/19  
5,465,841 A \* 11/1995 Wilson et al. .... 206/366  
D415,328 S \* 10/1999 Uehara et al. .... D34/19  
D598,109 S 8/2009 Collins et al.  
D609,350 S 2/2010 Hickey et al.

D613,411 S 4/2010 Collins et al.  
D629,906 S 12/2010 Hickey et al.  
D631,548 S 1/2011 McGill et al.  
D637,293 S 5/2011 Hickey et al.  
D639,930 S 6/2011 Collins et al.  
D646,392 S 10/2011 Collins et al.  
D650,063 S 12/2011 Collins et al.  
D663,844 S 7/2012 McGill et al.  
D664,255 S 7/2012 Hickey et al.  
D664,660 S 7/2012 Hickey et al.  
D675,727 S 2/2013 Collins et al.  
2007/0138922 A1 \* 6/2007 Frederick et al. .... 312/109

\* cited by examiner

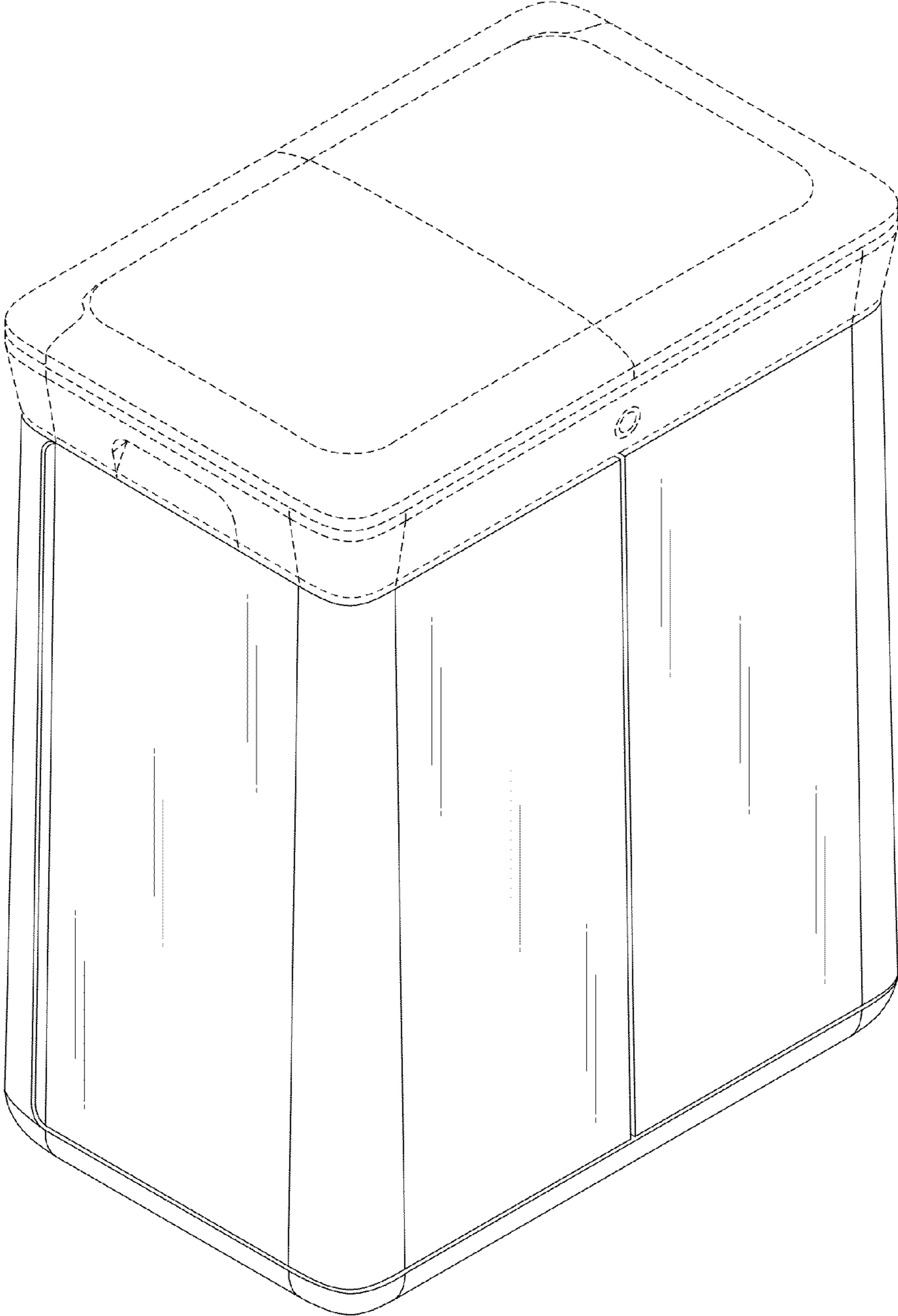
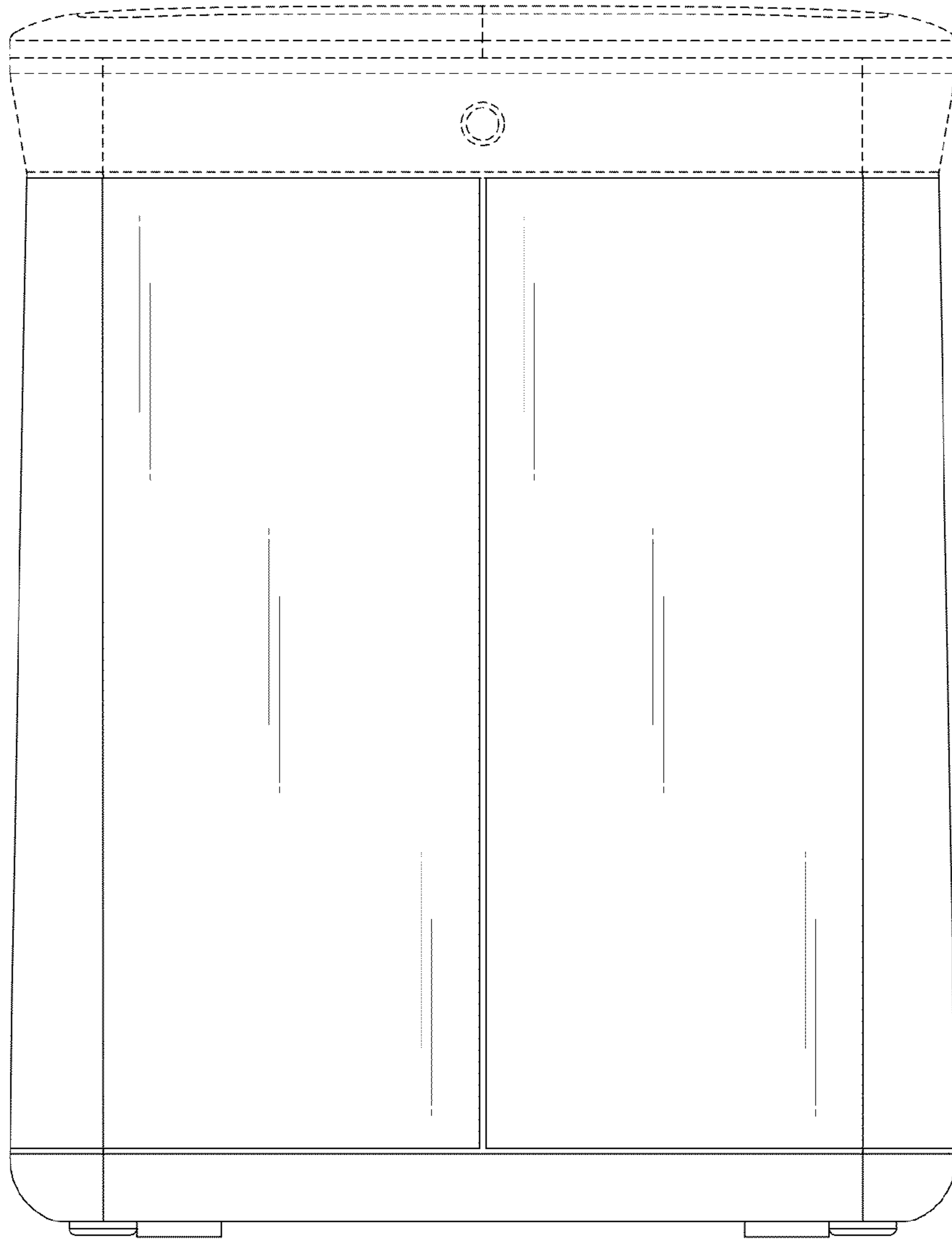


FIG. 1



**FIG. 2**

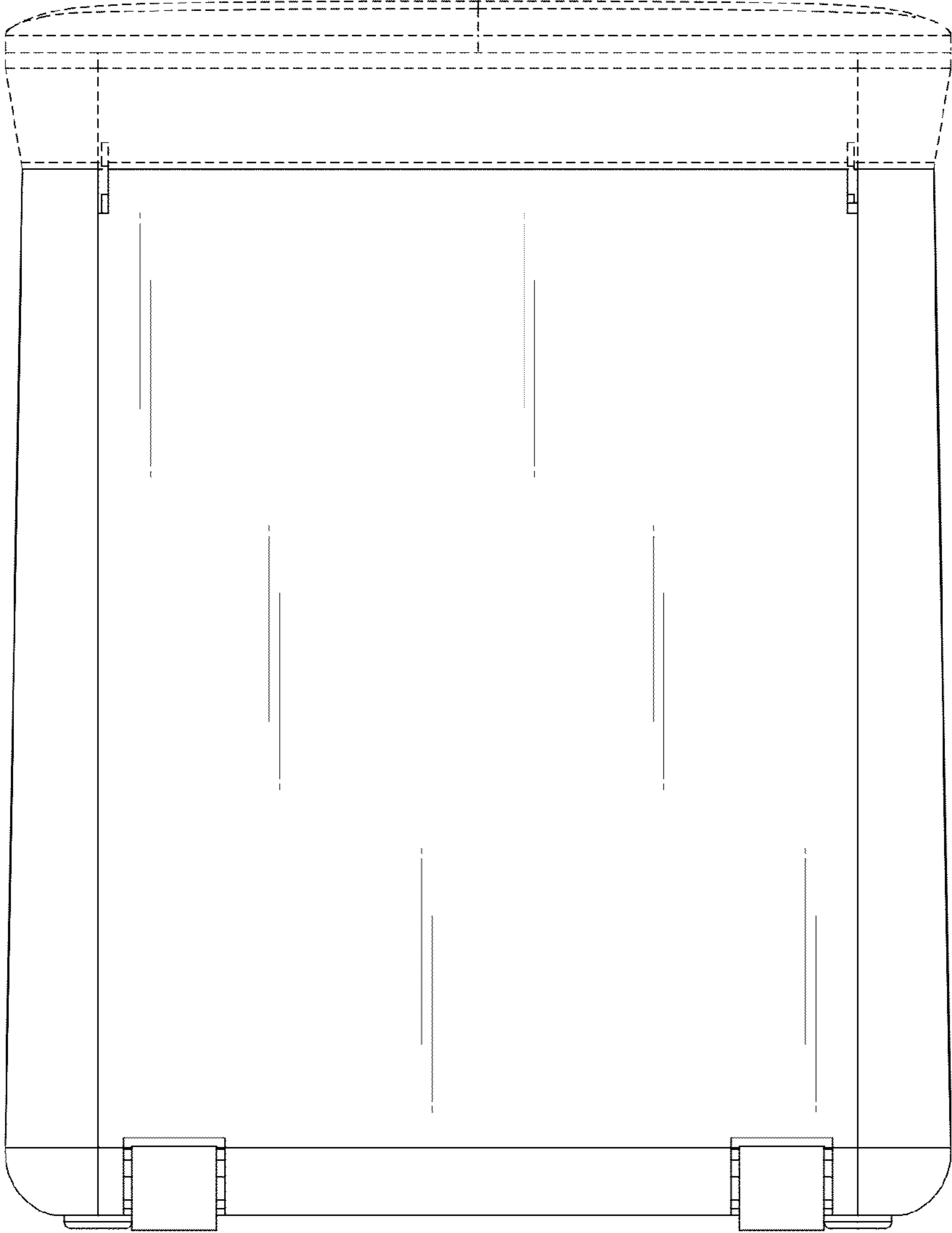


FIG. 3

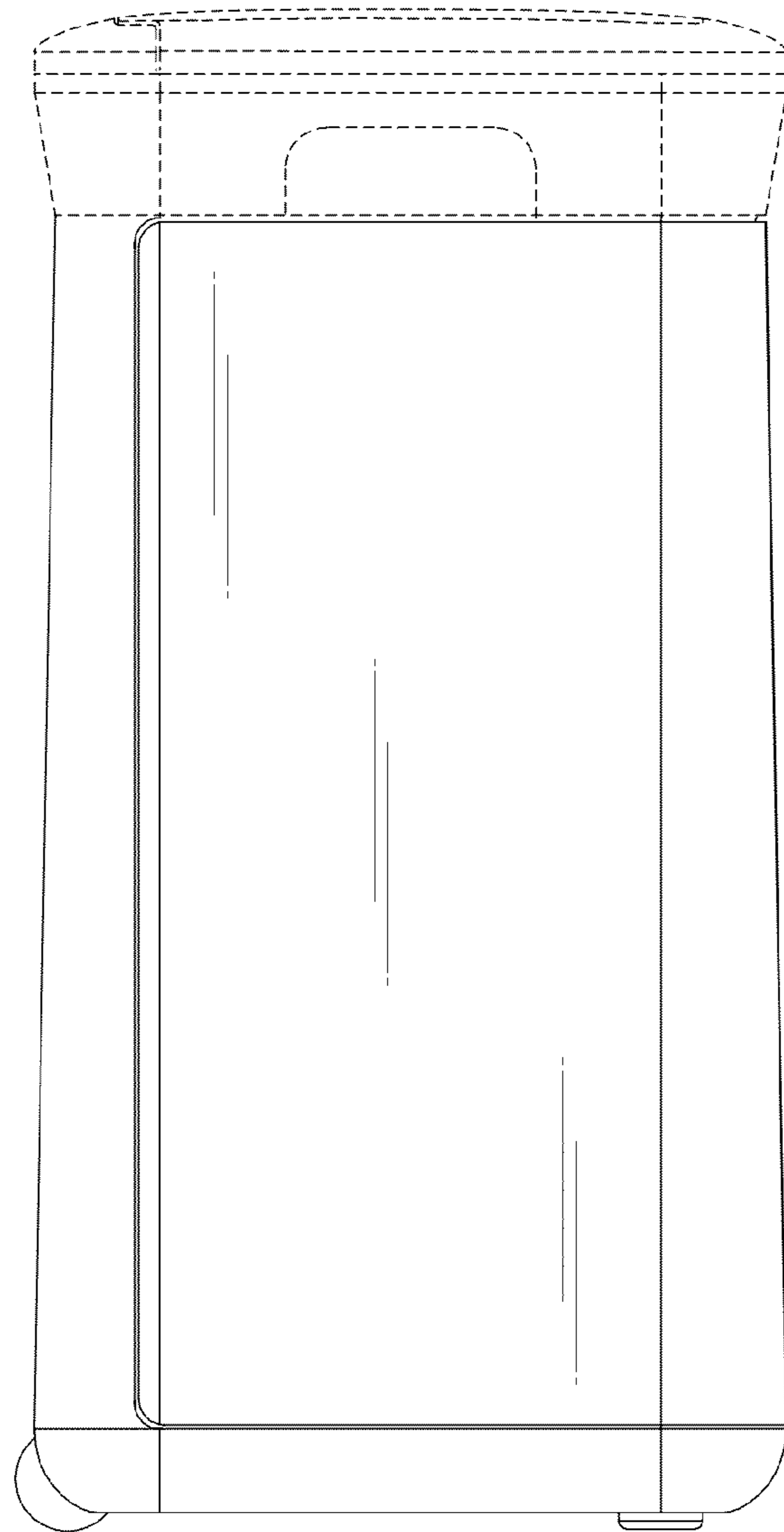
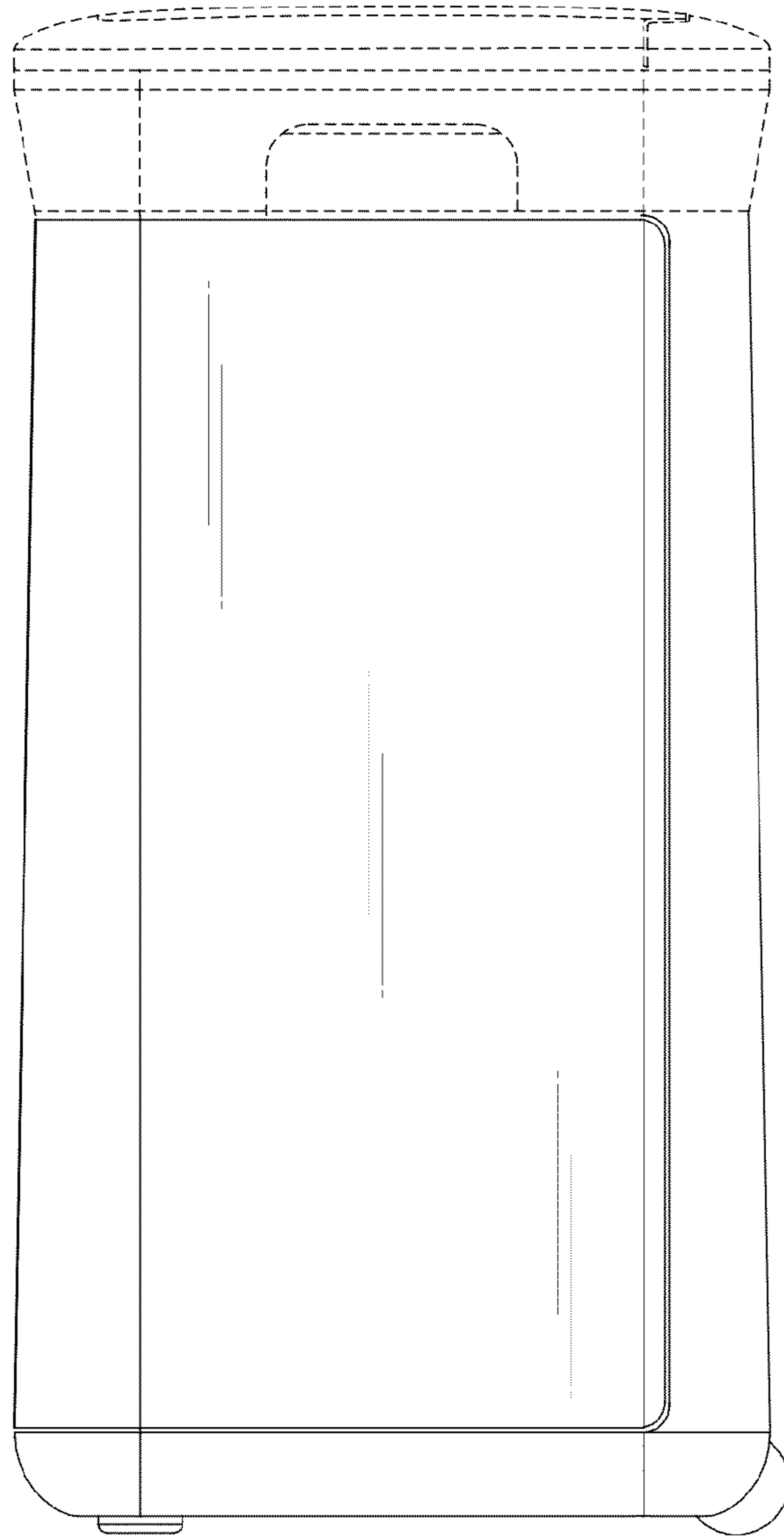
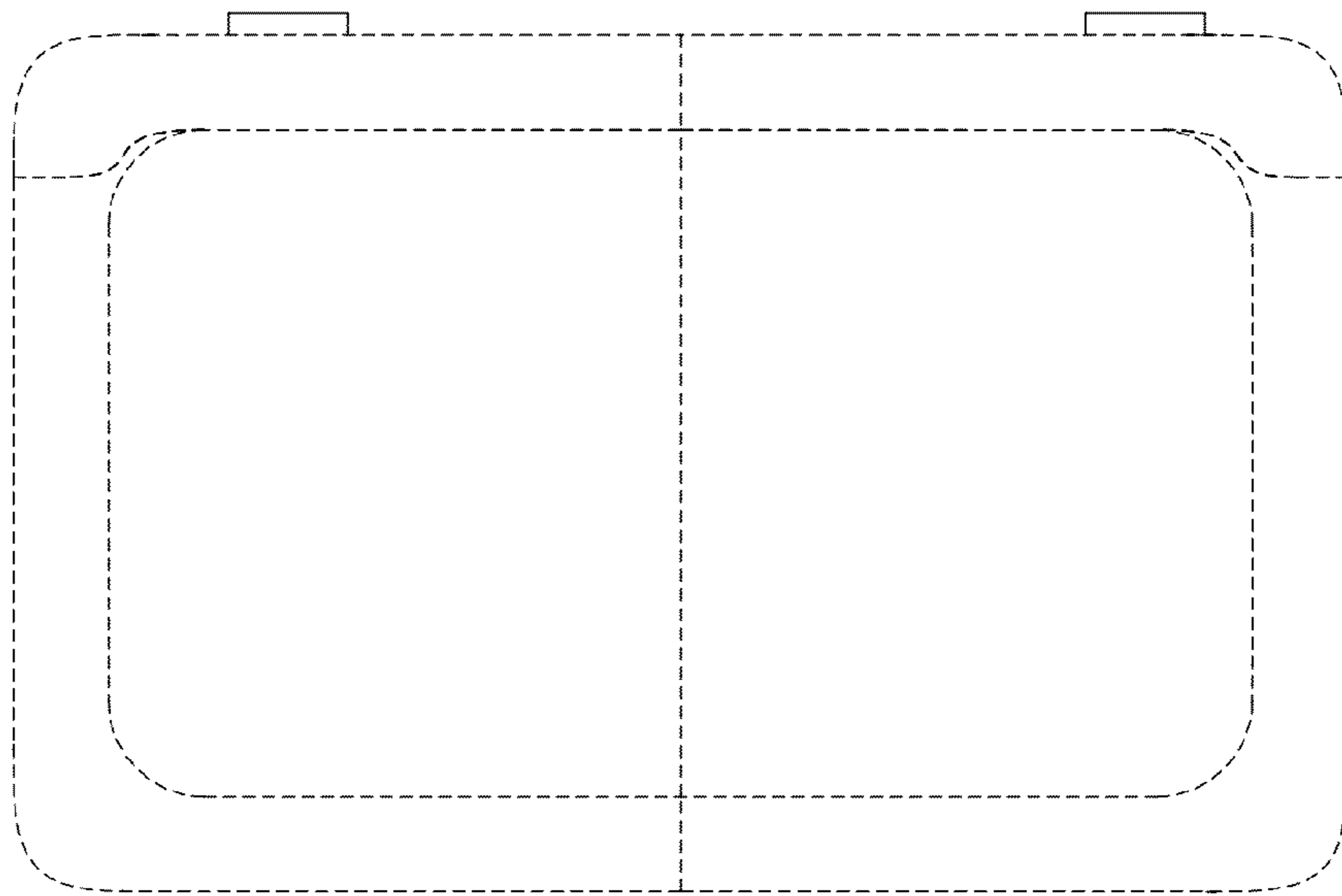


FIG. 4



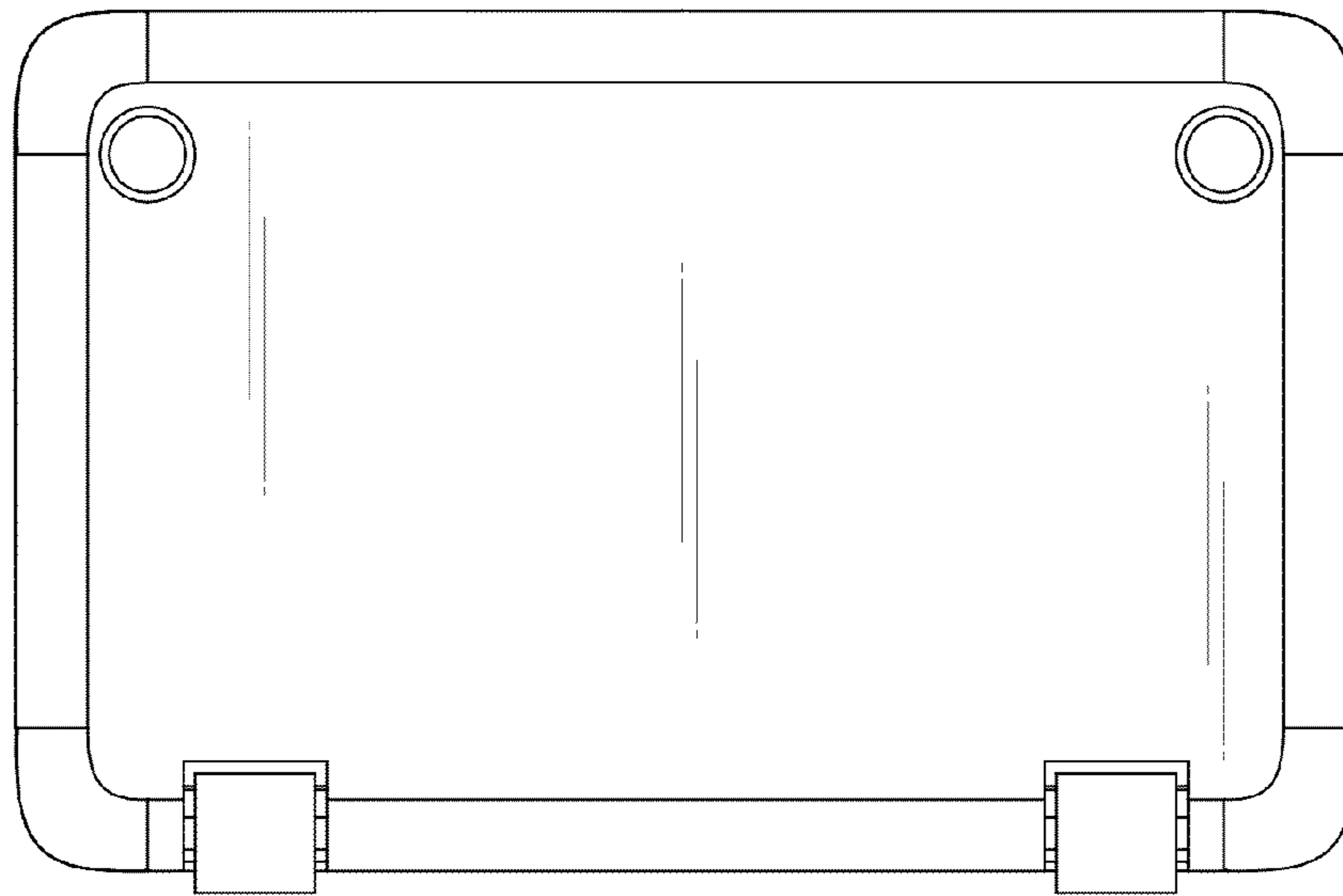


**FIG. 5**

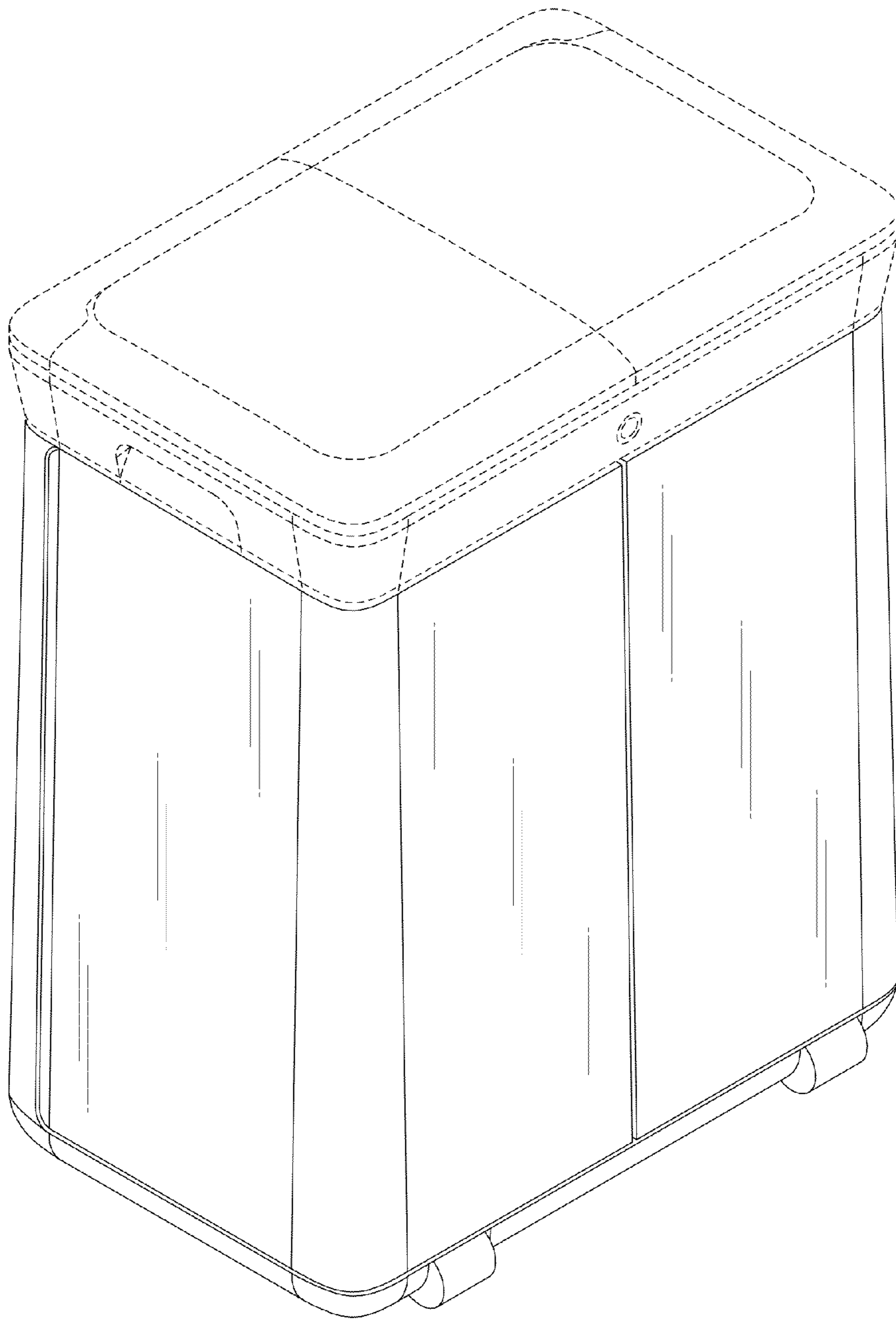


**FIG. 6**





**FIG. 7**



**FIG. 8**

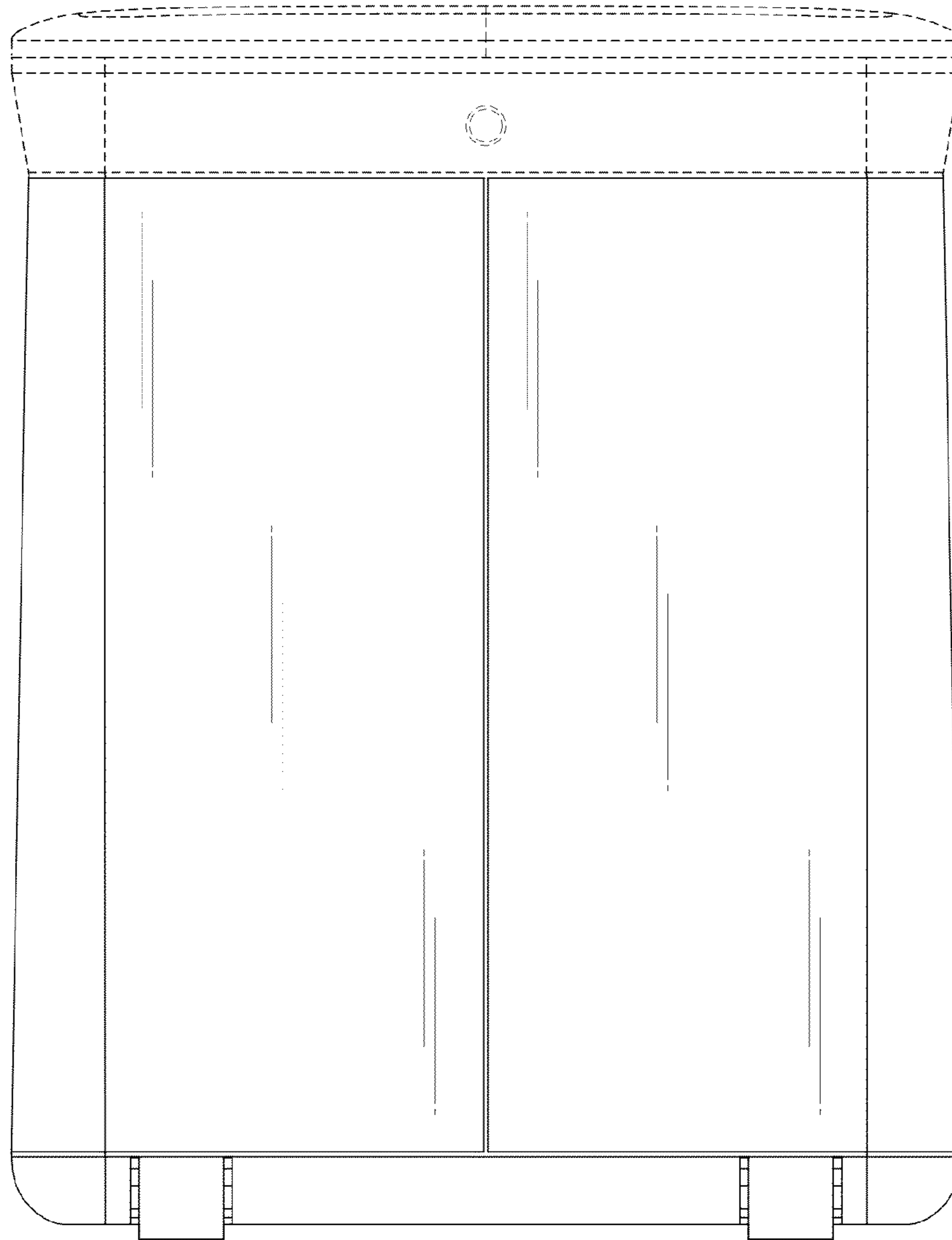


FIG. 9

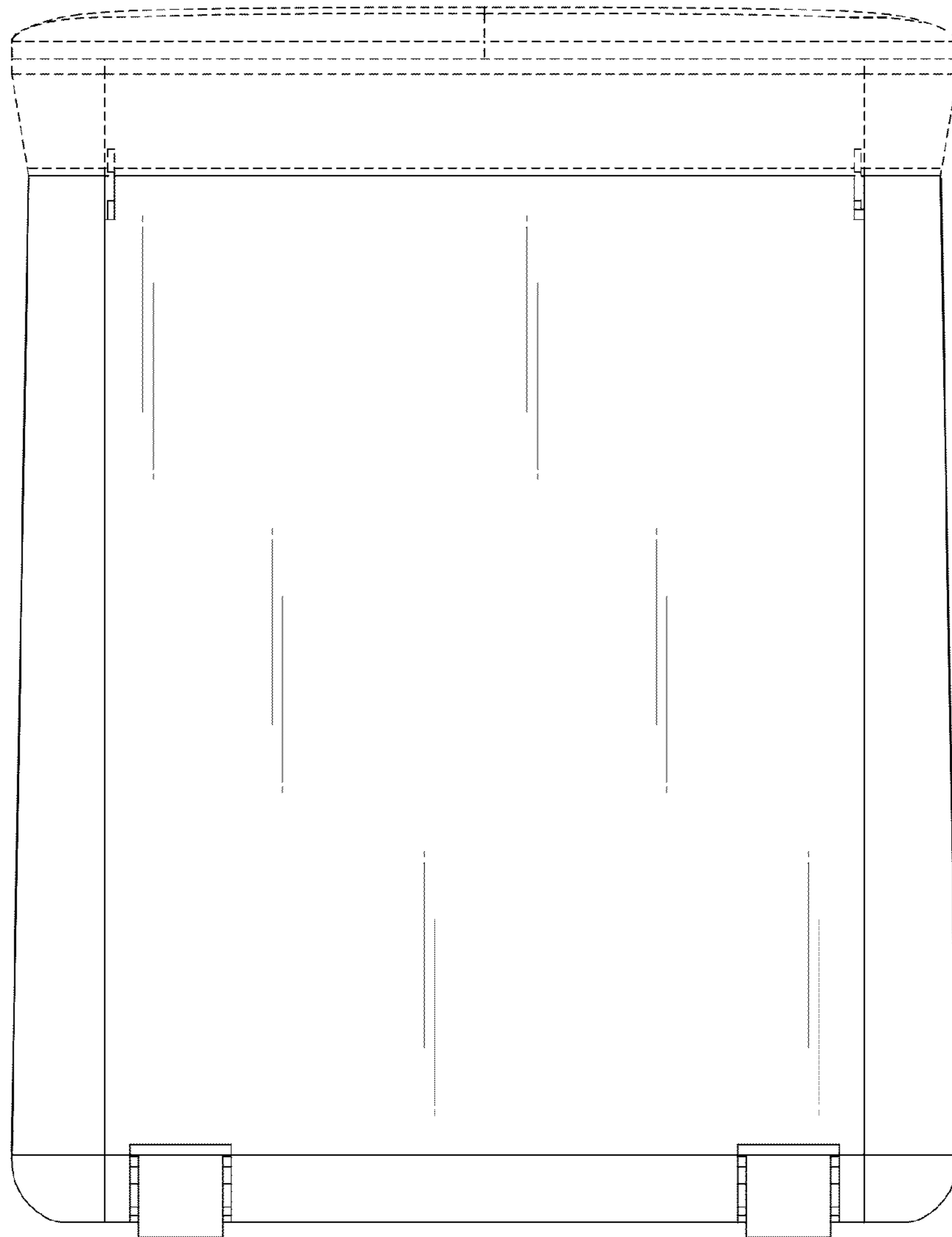
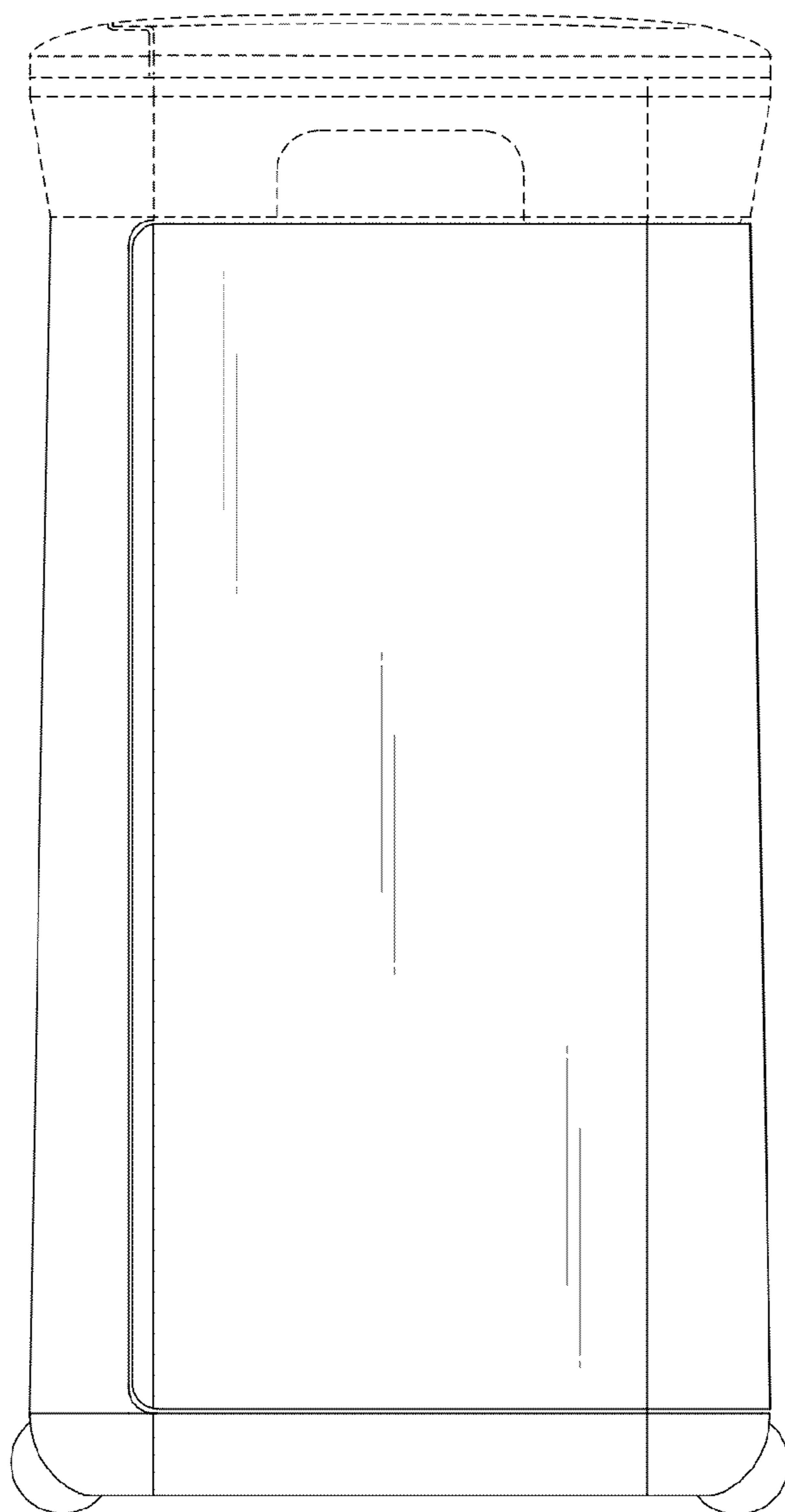
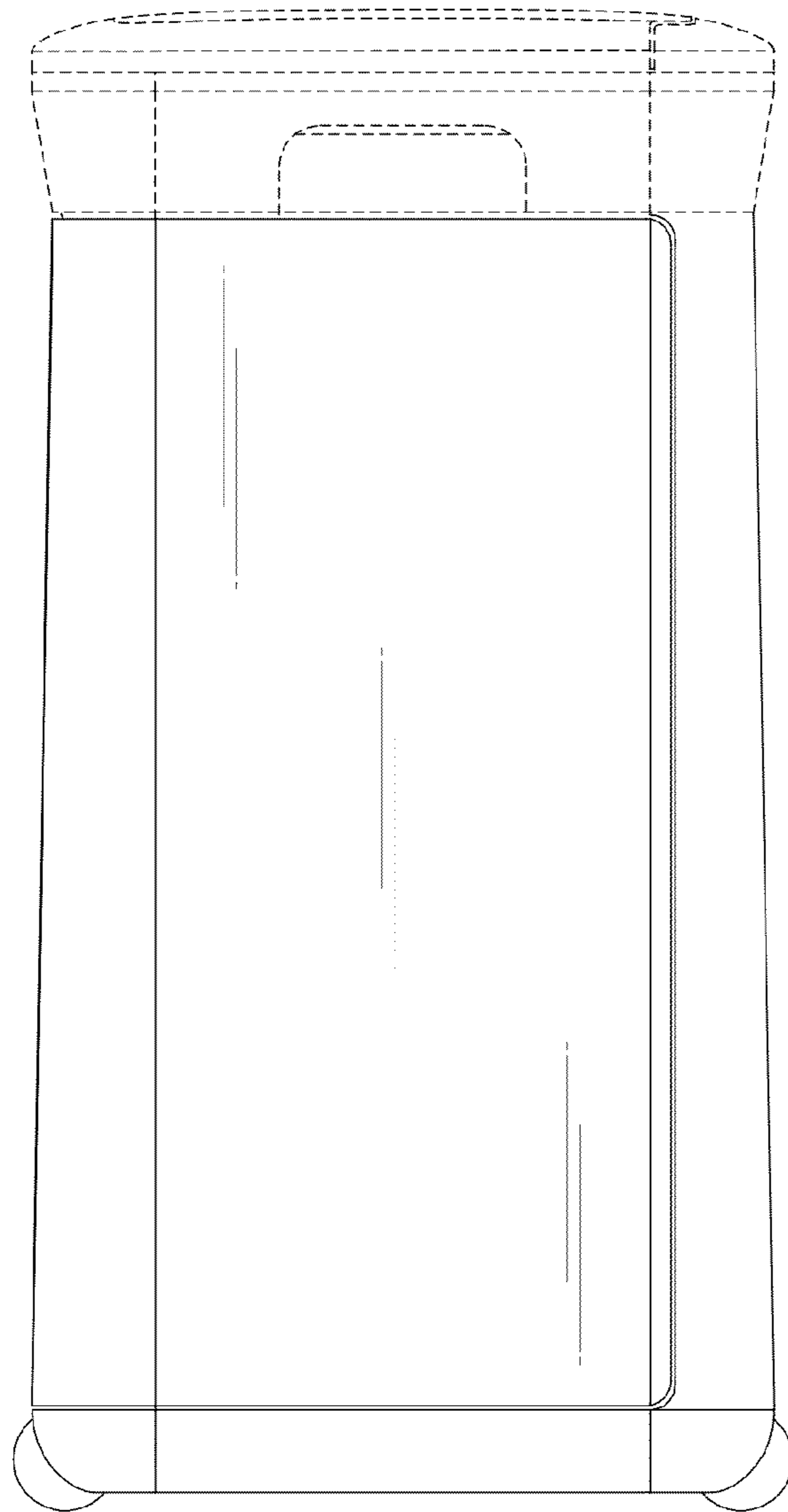


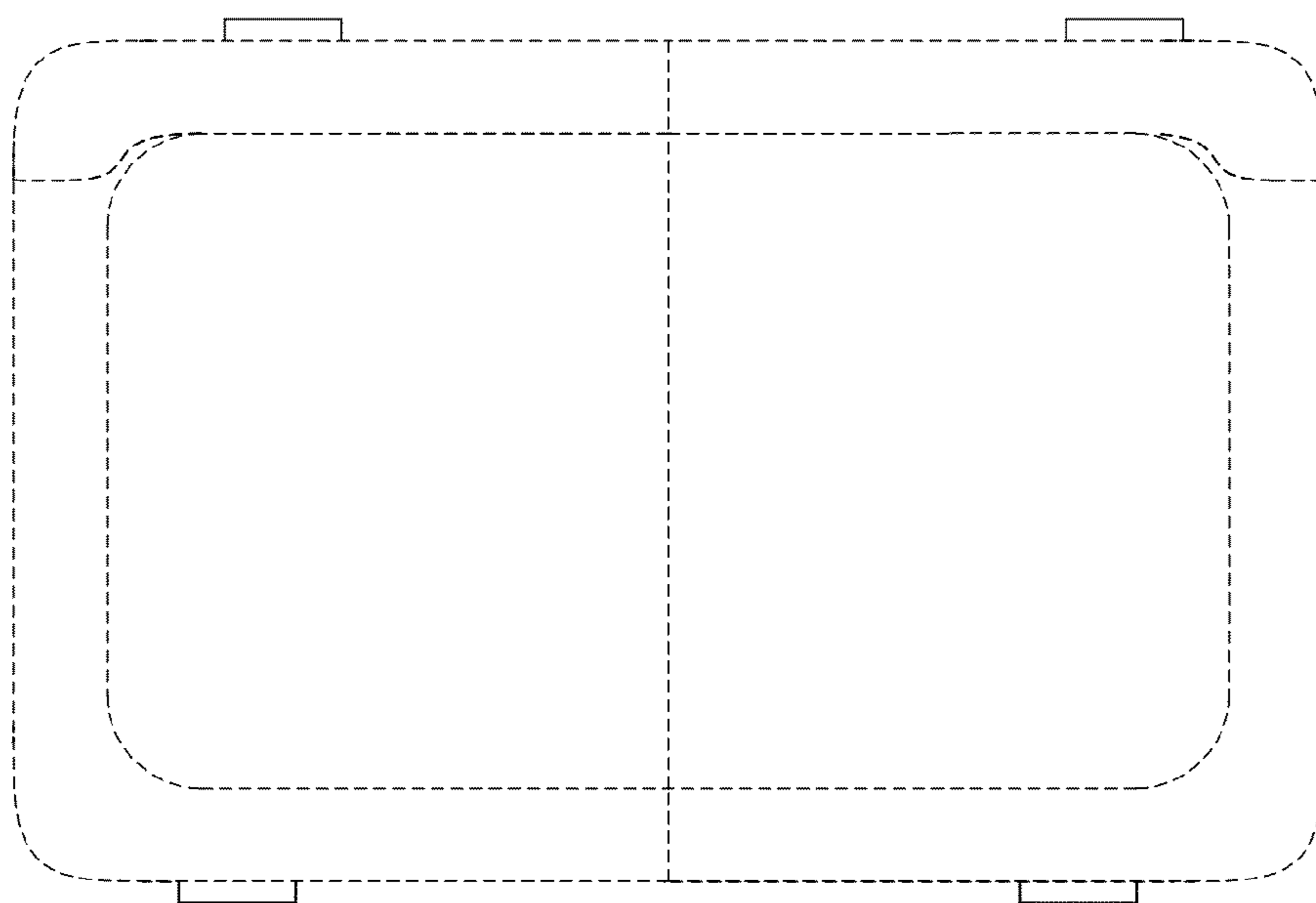
FIG. 10



**FIG. 11**

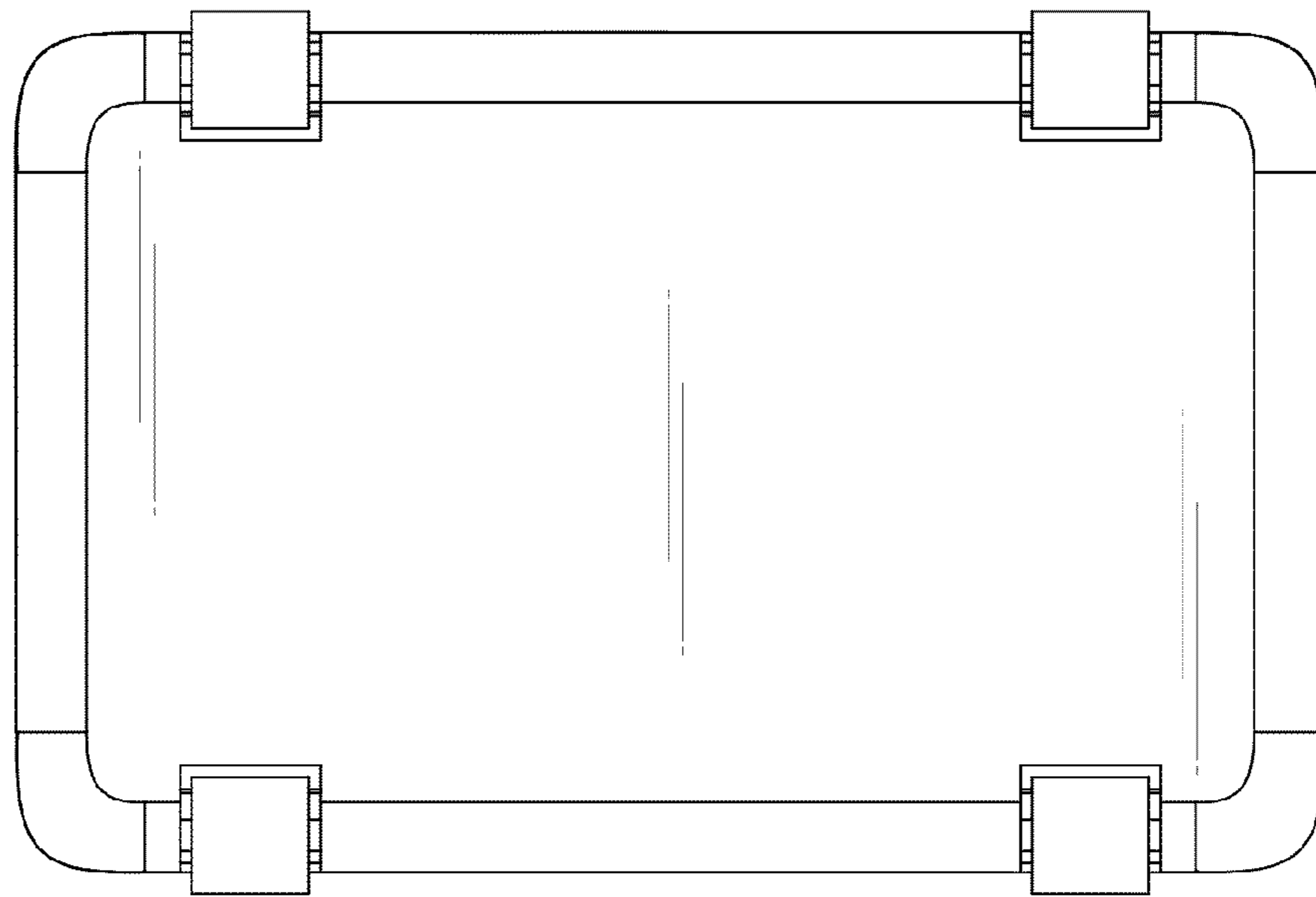


**FIG. 12**



**FIG. 13**





**FIG. 14**