



US00D714922S

(12) **United States Design Patent**
Speh

(10) **Patent No.:** **US D714,922 S**
(45) **Date of Patent:** **** Oct. 7, 2014**

(54) **VAPORIZER**

(75) Inventor: **Christoph Speh**, Mühlheim an der Ruhr (DE)

(73) Assignee: **WIK Far East Ltd.**, Hong Kong (CN)

(**) Term: **14 Years**

(21) Appl. No.: **29/406,979**

(22) Filed: **Nov. 21, 2011**

(30) **Foreign Application Priority Data**

May 20, 2011 (EM) 001866385

(51) **LOC (10) Cl.** **23-04**

(52) **U.S. Cl.**
USPC **D23/360**

(58) **Field of Classification Search**
USPC D23/355–366, 352, 369, 332, 333, 335,
D23/336, 342, 351; 422/120, 122; 55/356,
55/473, 504; 96/97; 261/DIG. 17, DIG. 65,
261/DIG. 88, DIG. 31
See application file for complete search history.

(56) **References Cited**

U.S. PATENT DOCUMENTS

D247,573	S *	3/1978	Schimanski	D23/366
D419,658	S *	1/2000	Matchett et al.	D23/356
D424,675	S *	5/2000	Grace et al.	D23/360
D427,300	S *	6/2000	Pinchuk	D23/364
D430,277	S *	8/2000	Schmulling	D23/333
D437,038	S *	1/2001	Chuan	D23/364
D485,338	S *	1/2004	Augustine et al.	D23/332
D497,664	S *	10/2004	Puri	D23/364
D542,903	S *	5/2007	Caserta et al.	D23/366
D584,809	S *	1/2009	Porchia et al.	D23/366
D596,730	S *	7/2009	Langley et al.	D23/366
D620,578	S *	7/2010	Russell et al.	D23/366
8,551,409	B2 *	10/2013	Yamamoto et al.	422/123

OTHER PUBLICATIONS

U.S. Appl. No. 29/408,716, filed Dec. 15, 2011; First Named Inventor: Christoph Speh.

* cited by examiner

Primary Examiner — David Muller

(74) *Attorney, Agent, or Firm* — Margaret Polson; Polson & Associates, PC

(57) **CLAIM**

The ornamental design for a vaporizer, as shown and described.

DESCRIPTION

FIG. 1 is a front perspective view of my new design for a vaporizer with a foot attachment mounted on the front.

FIG. 2 is a back perspective of FIG. 1.

FIG. 3 is a top plan view of FIG. 1.

FIG. 4 is bottom plan view of FIG. 1.

FIG. 5 is a side elevation view of the right and left side, which are mirror images thereof, of FIG. 1.

FIG. 6 is a front side elevation view of FIG. 1.

FIG. 7 is back side elevation view of FIG. 1.

FIG. 8 is a front perspective view of my new design for a vaporizer with the foot attachment removed for ease of illustration.

FIG. 9 is a back perspective of FIG. 8.

FIG. 10 is a top plan view of FIG. 8.

FIG. 11 is a bottom plan view of FIG. 8.

FIG. 12 is a side elevation view of the right and left side, which are mirror images thereof, of FIG. 8.

FIG. 13 is a front side elevation view of FIG. 8; and,

FIG. 14 is back side elevation view of FIG. 1.

The features shown in broken lines depict environmental subject matter only and form no part of the claimed design.

1 Claim, 11 Drawing Sheets

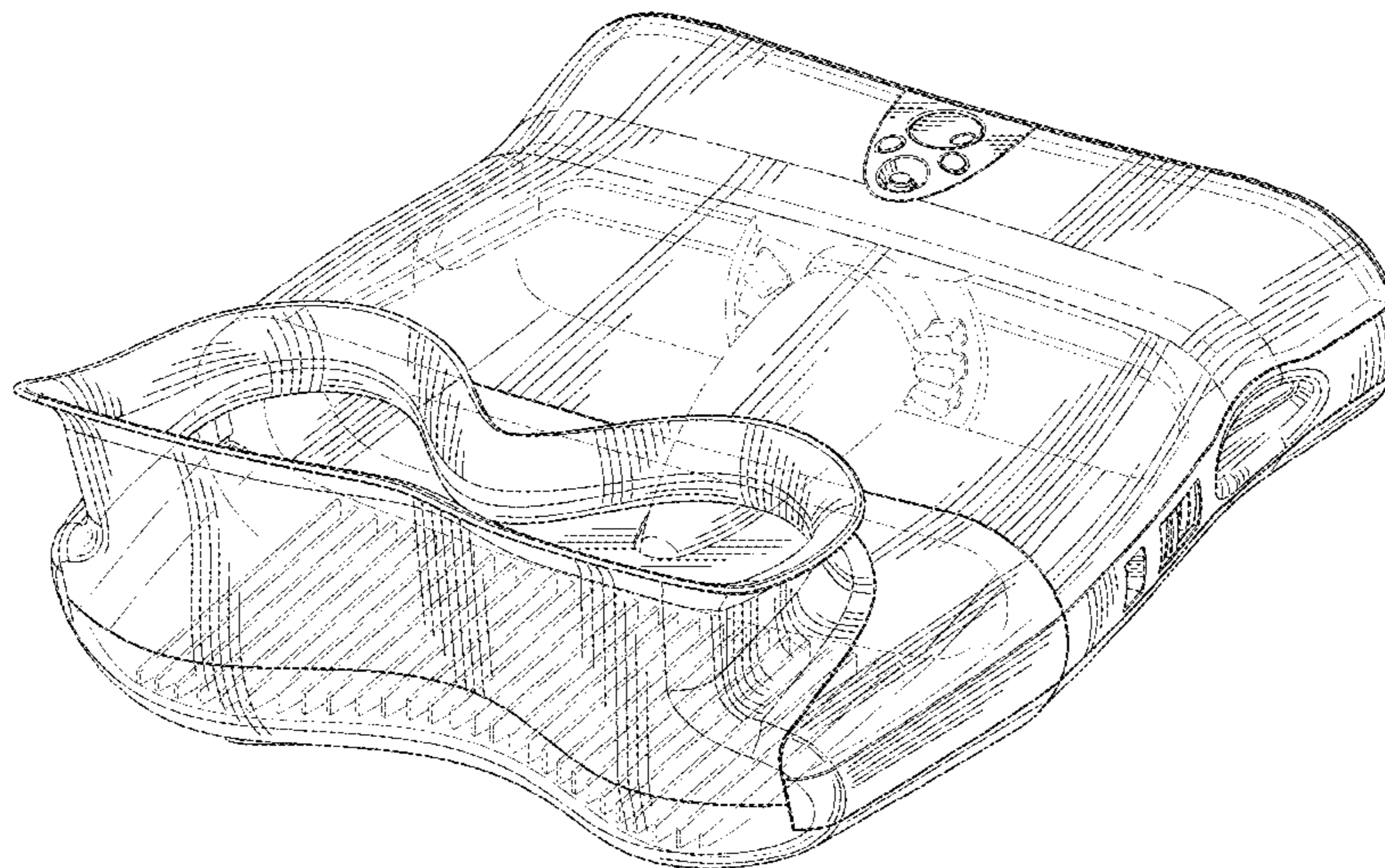

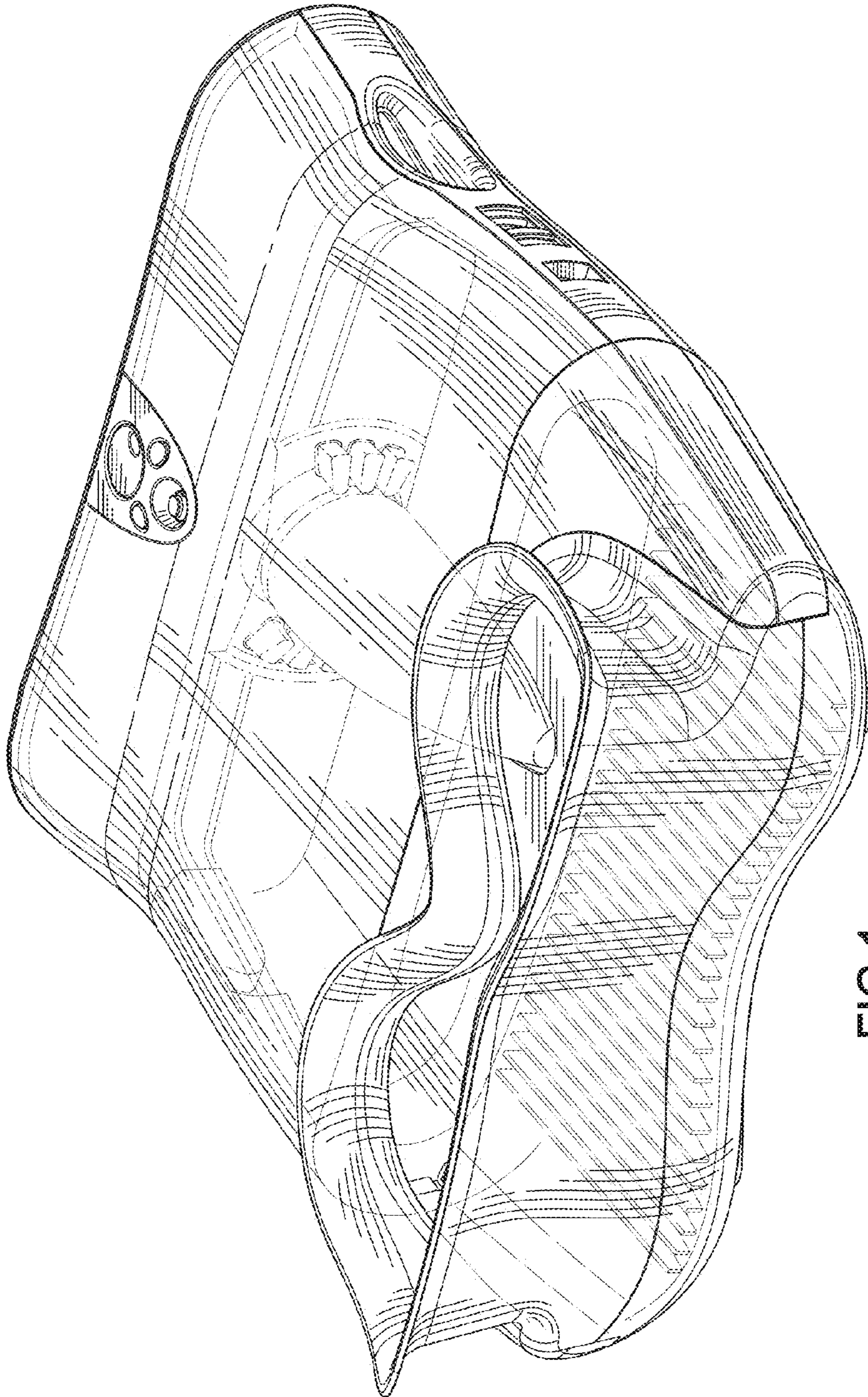

FIG.1

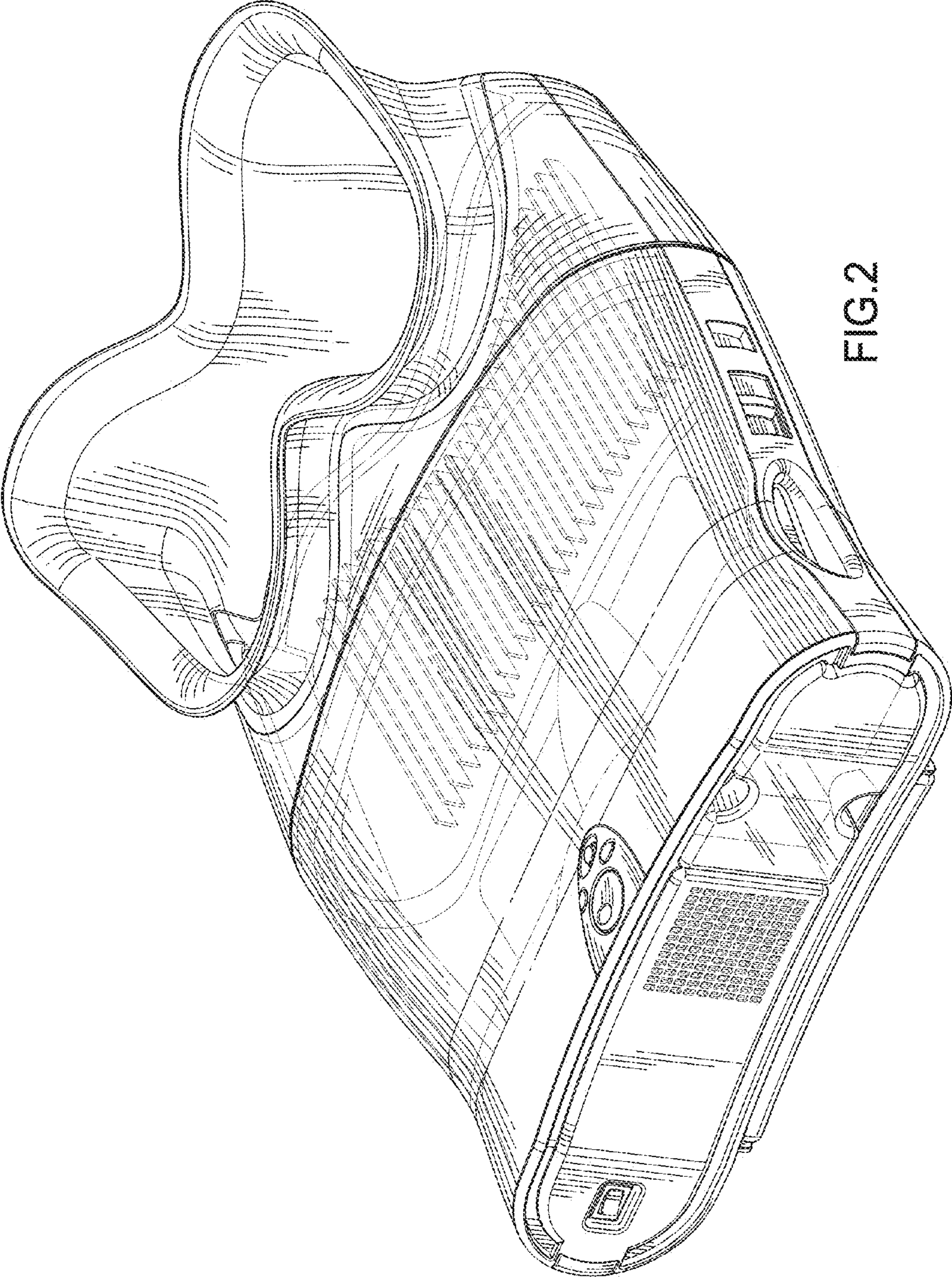

FIG.2

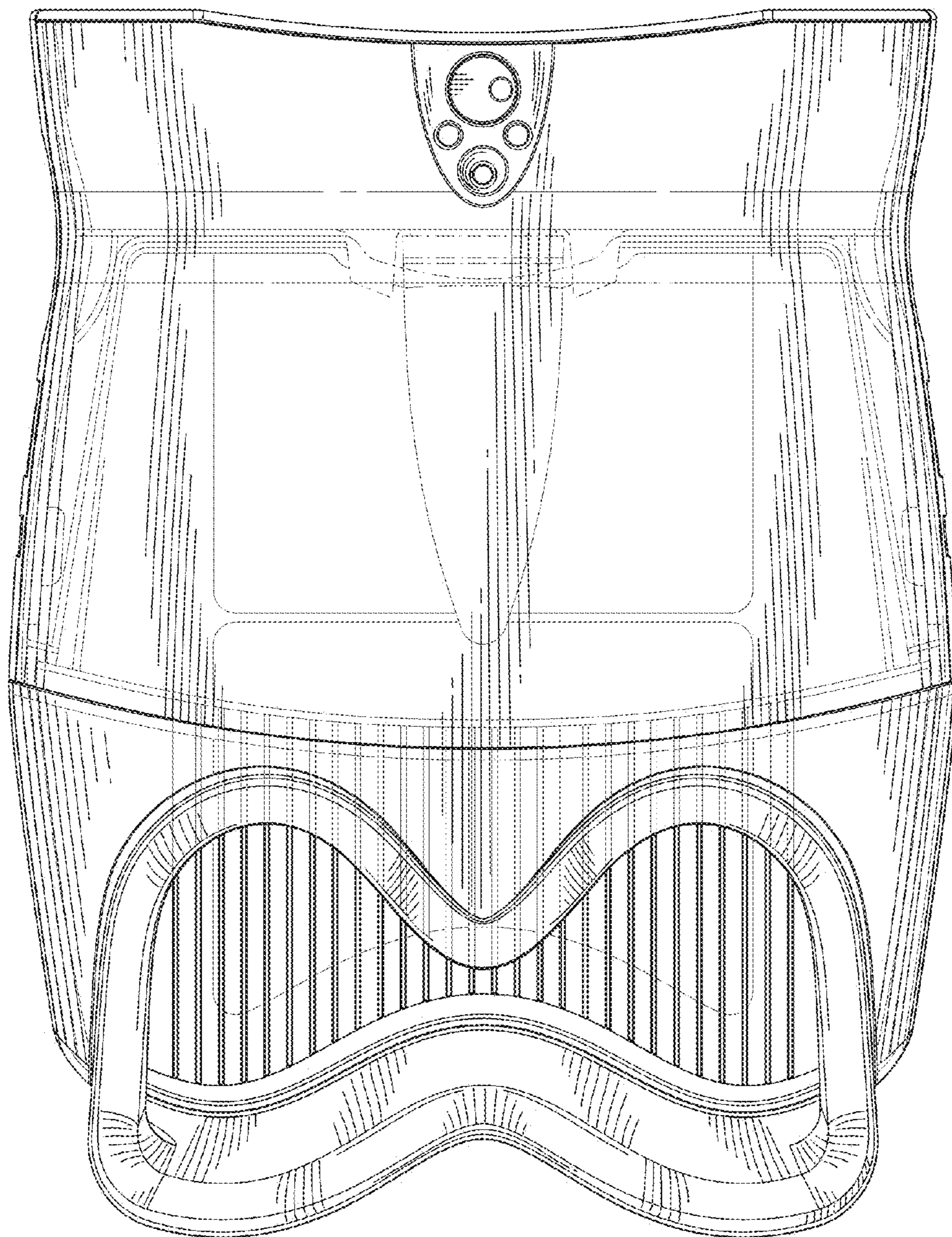

FIG. 3

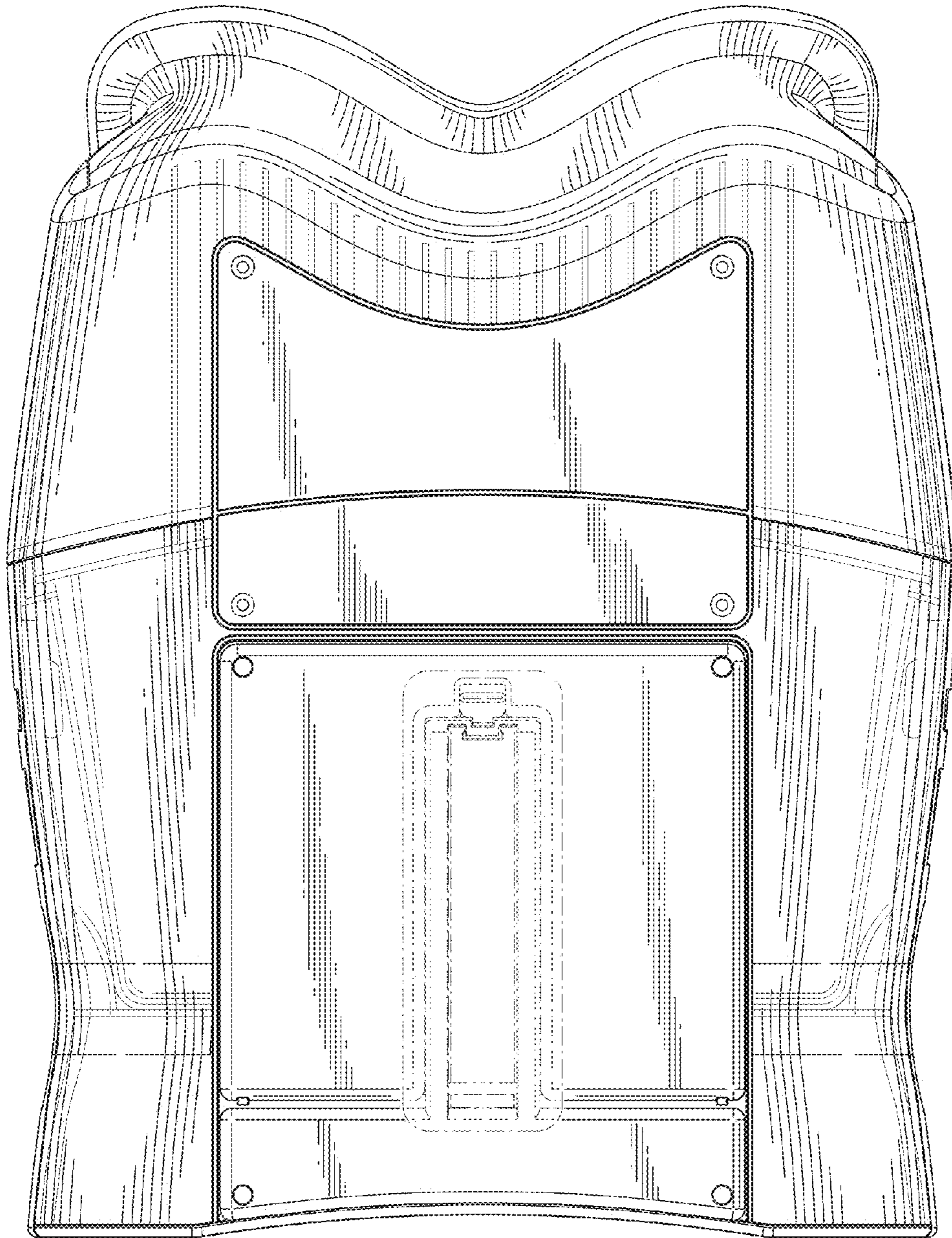

FIG.4

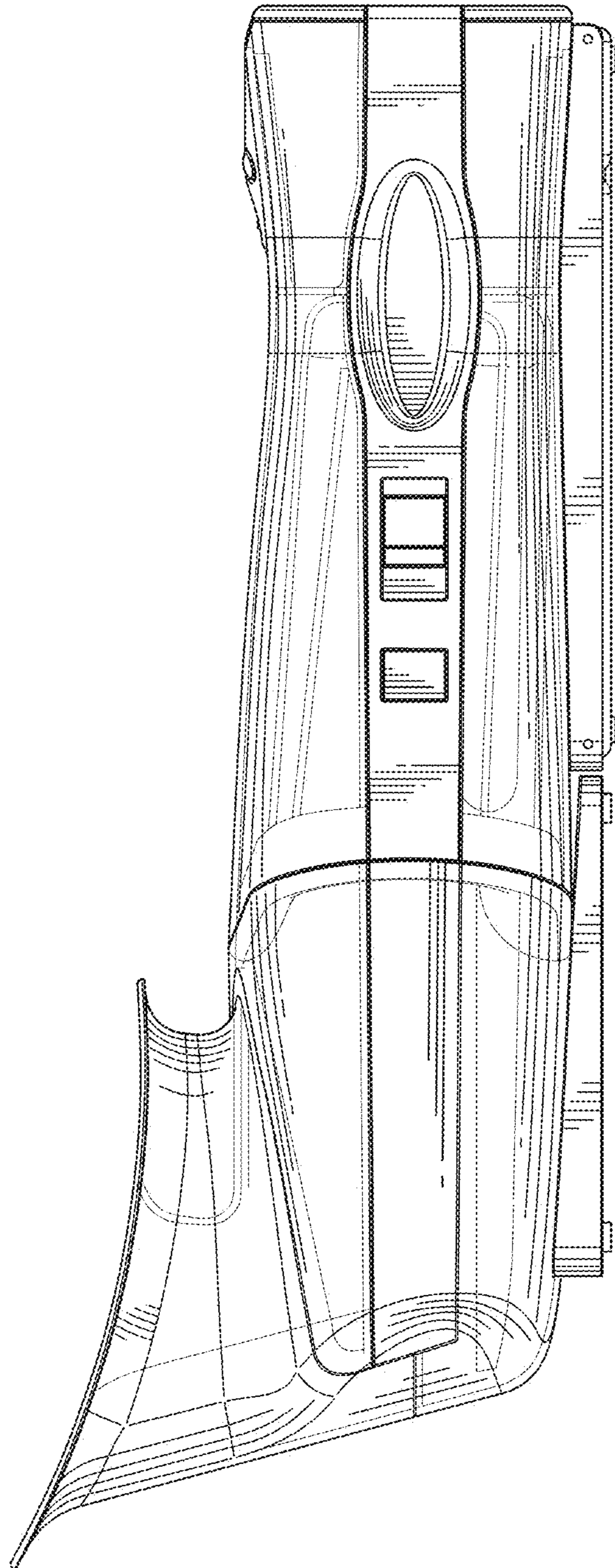

FIG.5

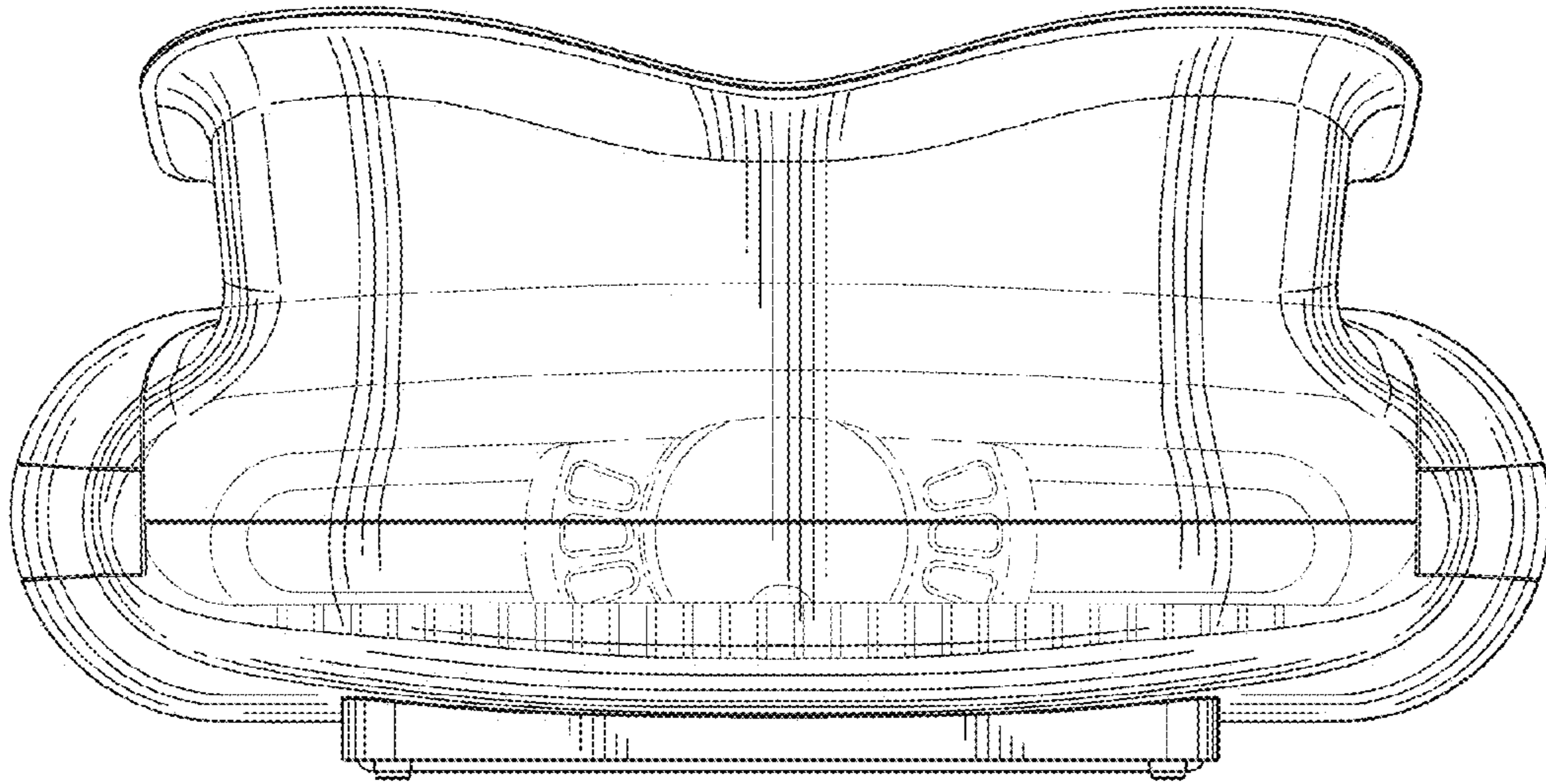

FIG. 6

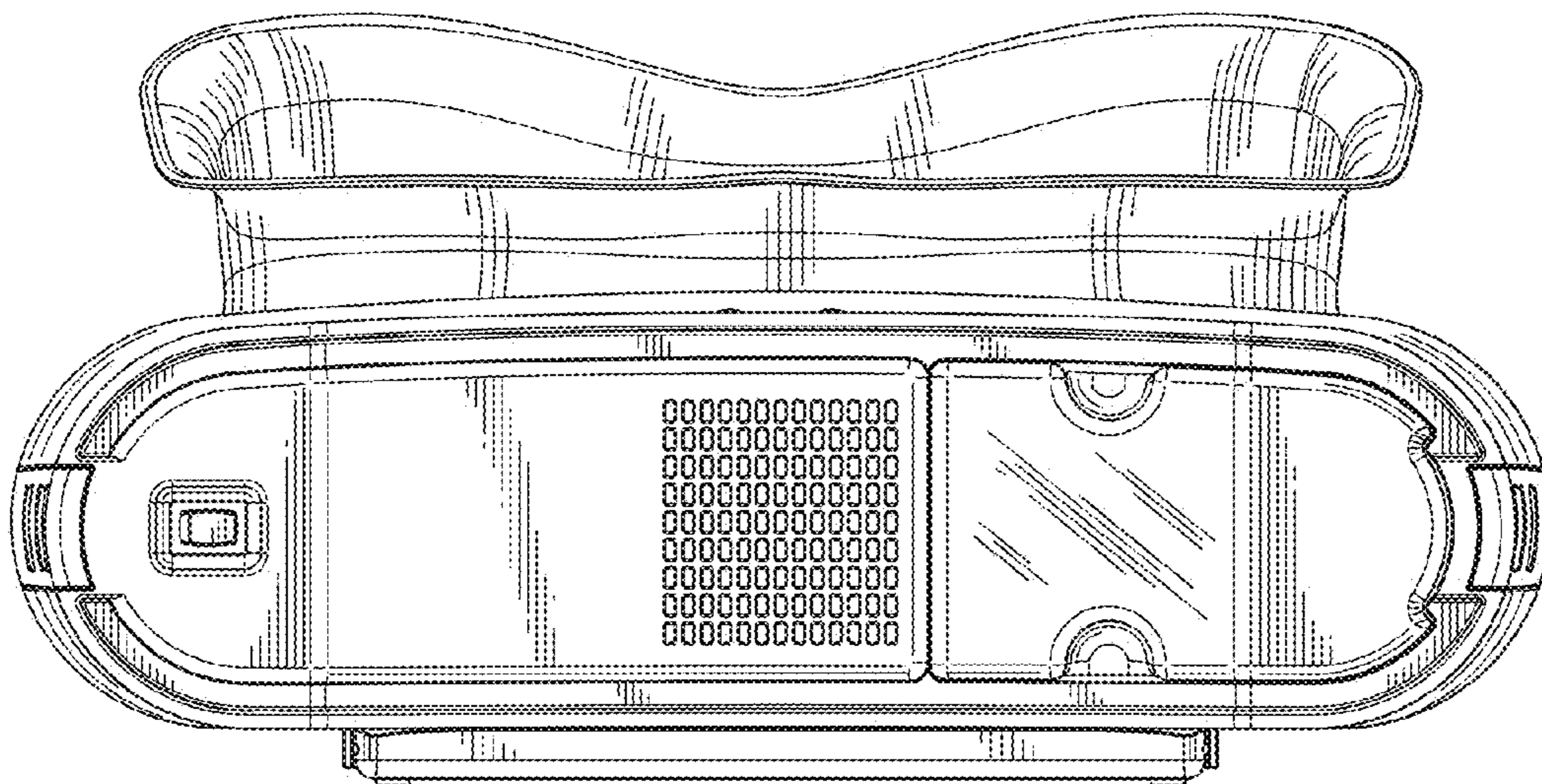

FIG. 7

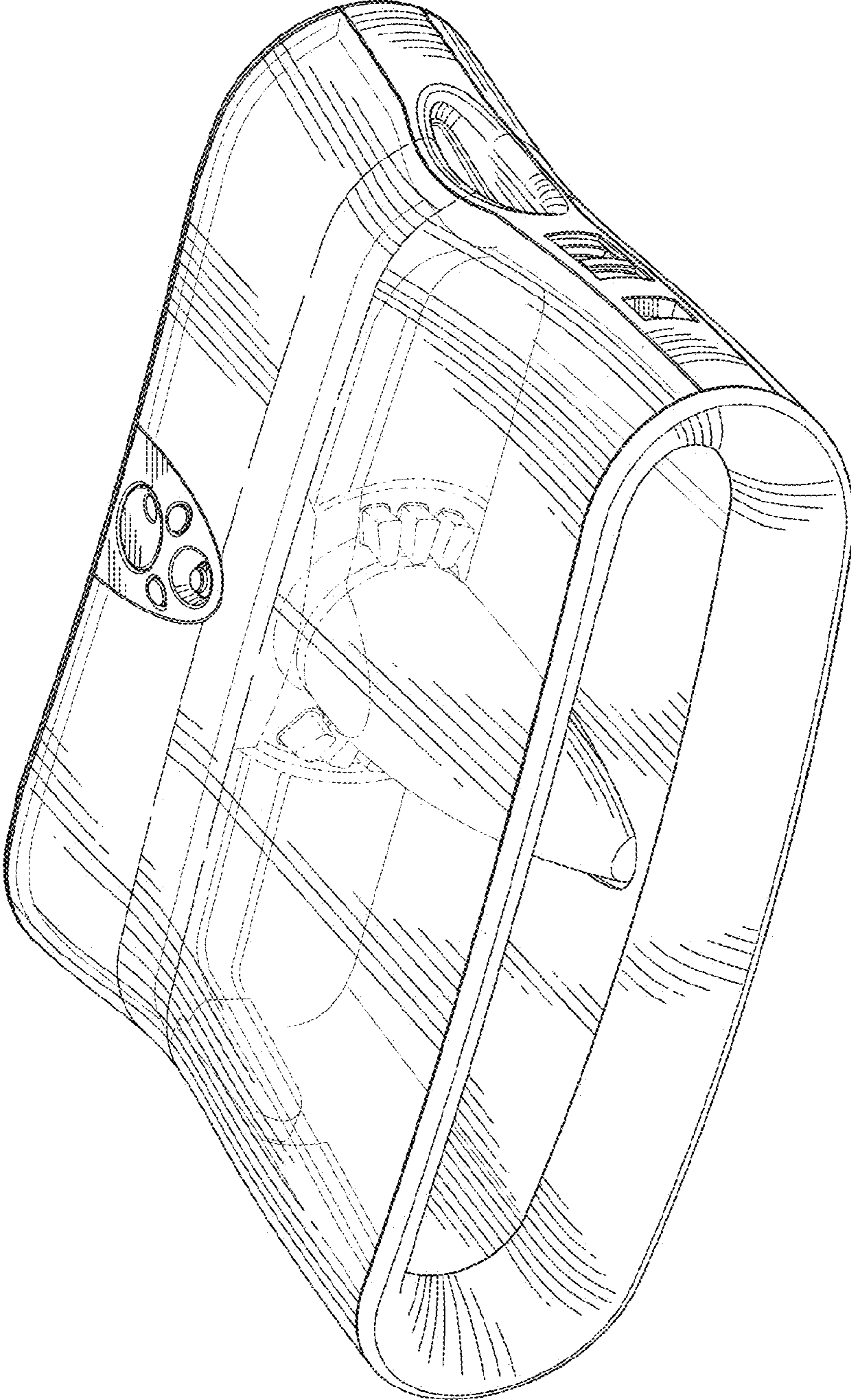

FIG.8

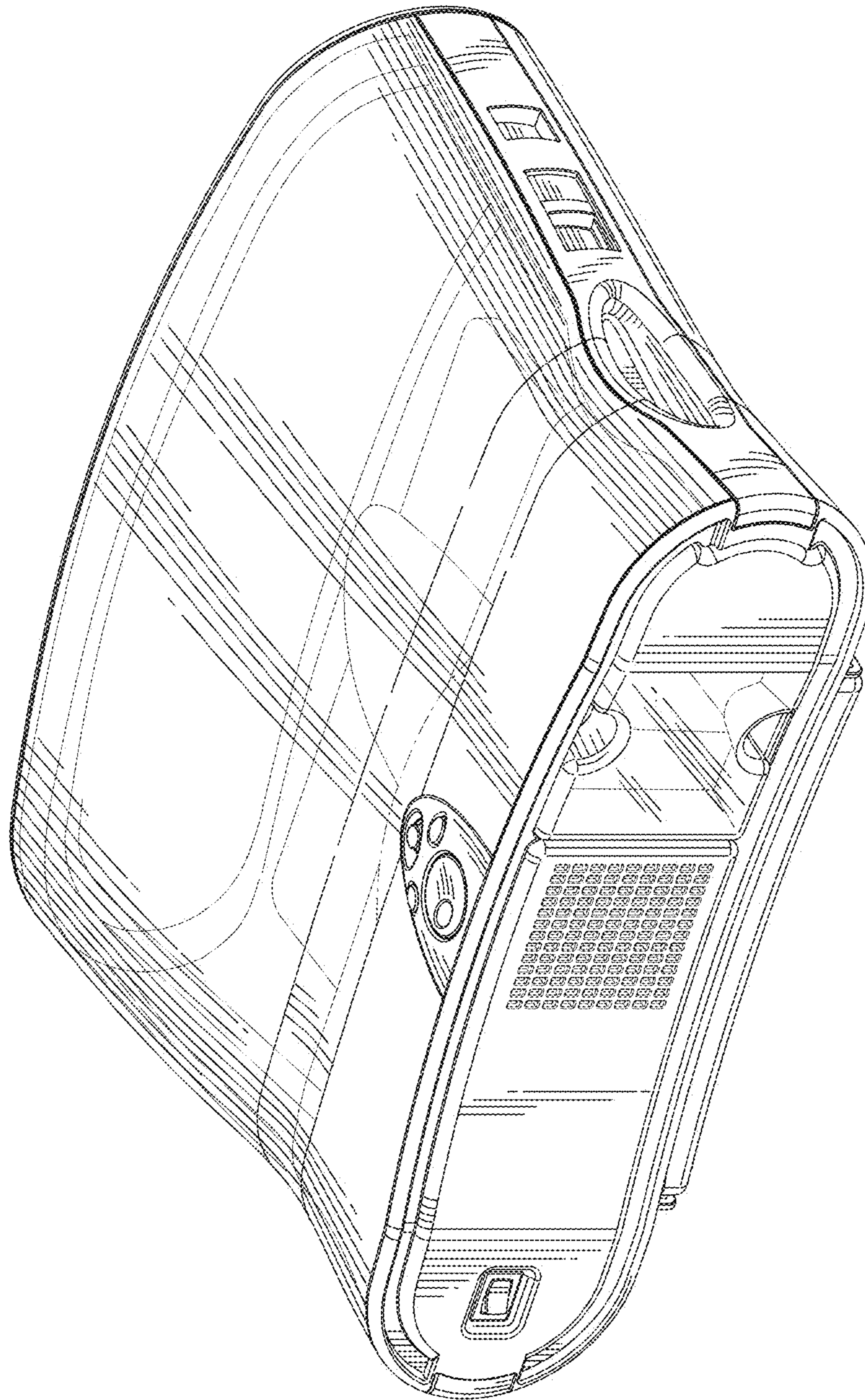

FIG. 9

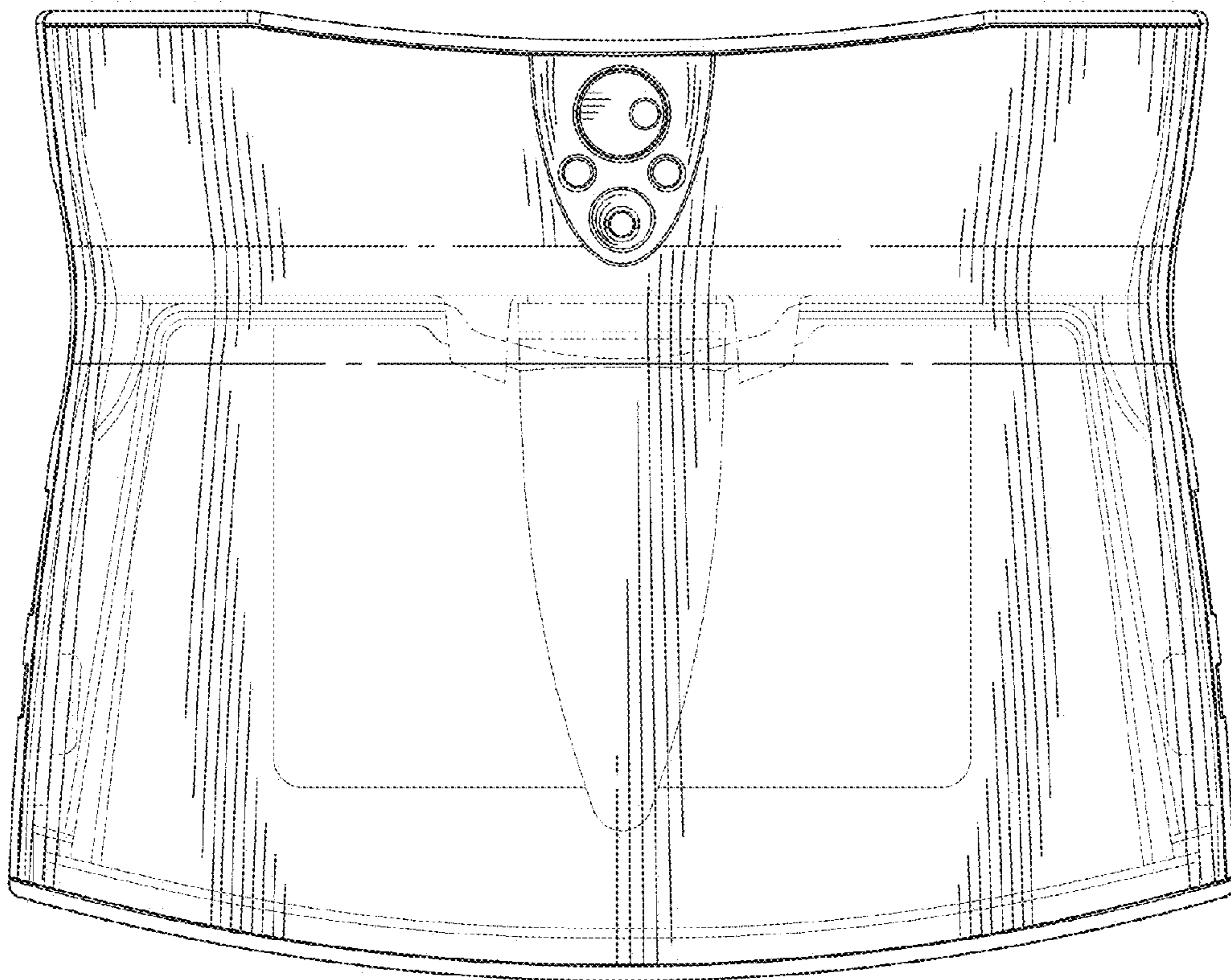

FIG. 10

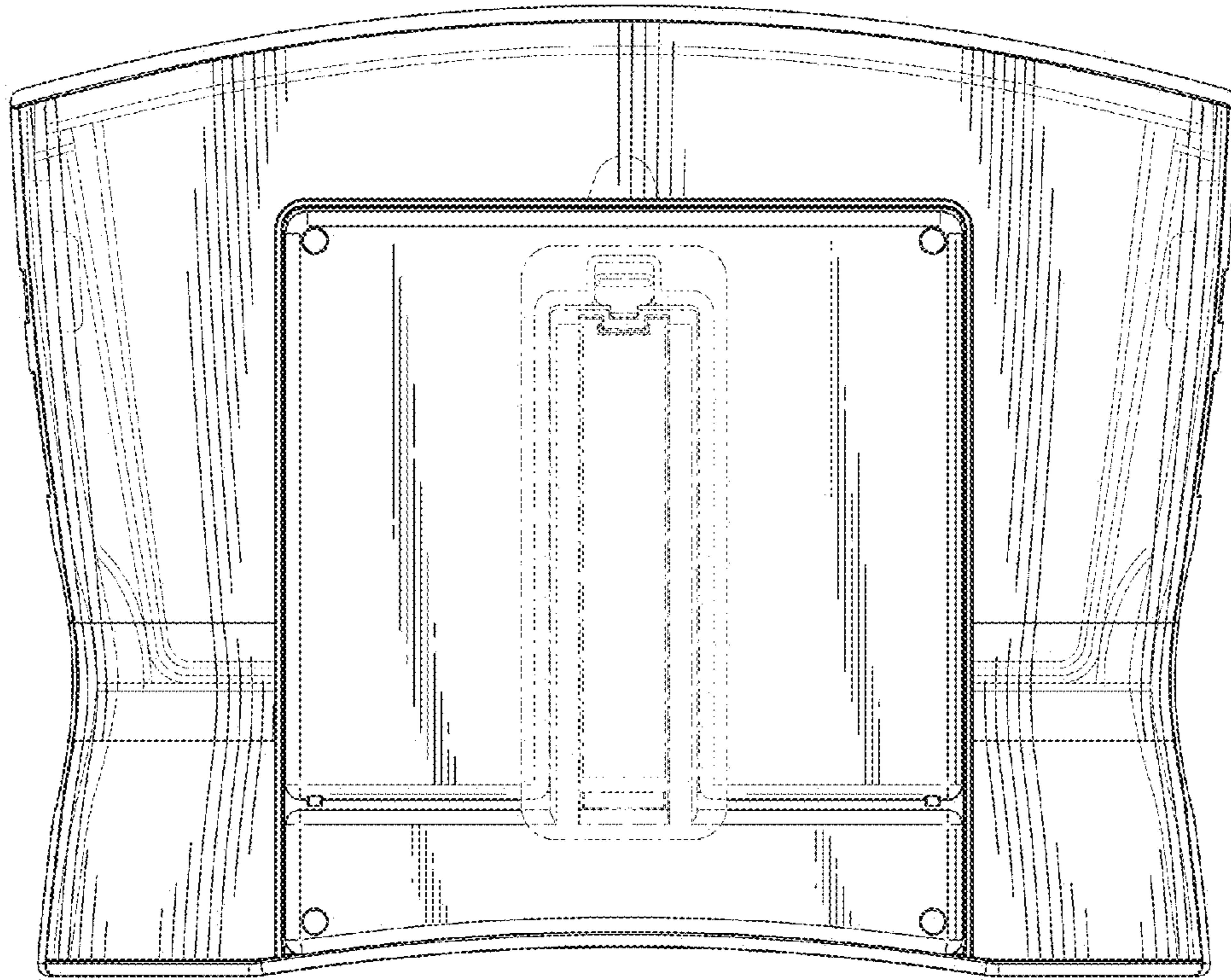

FIG. 11

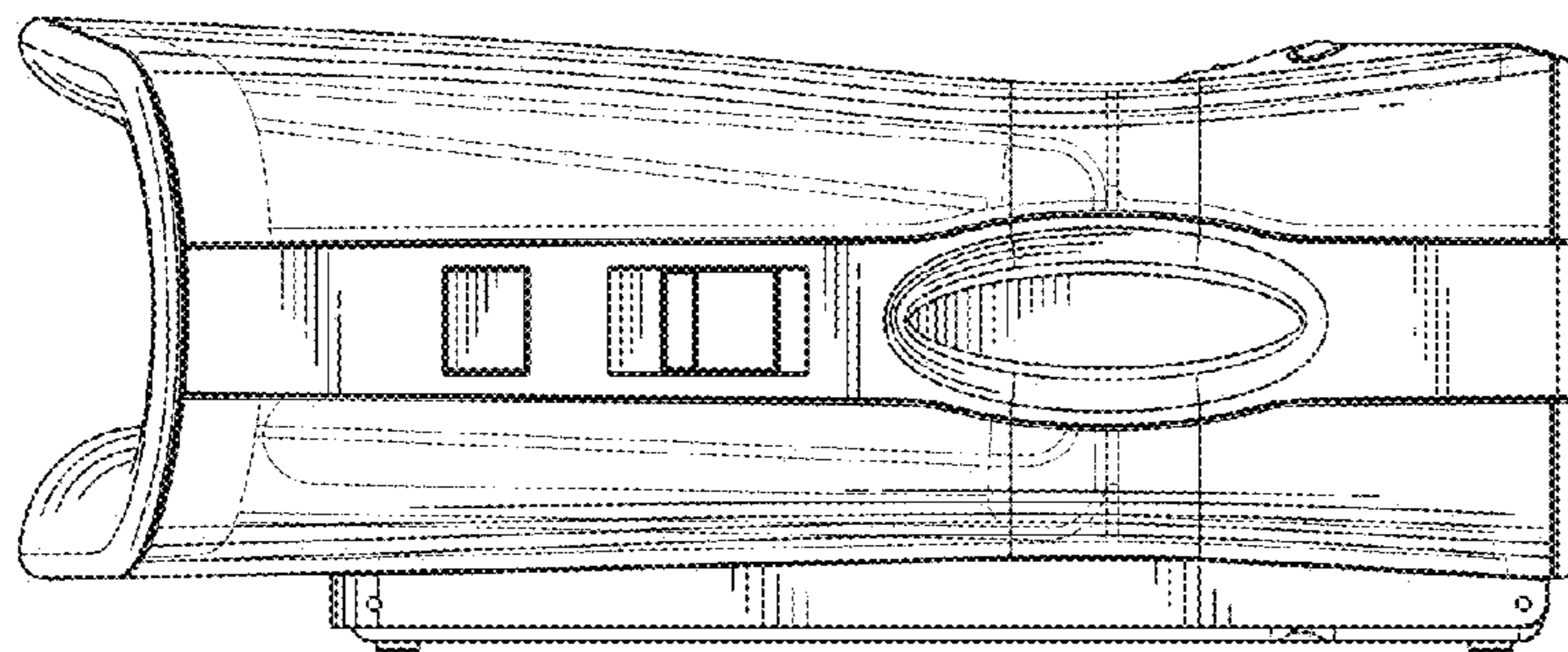

FIG. 12

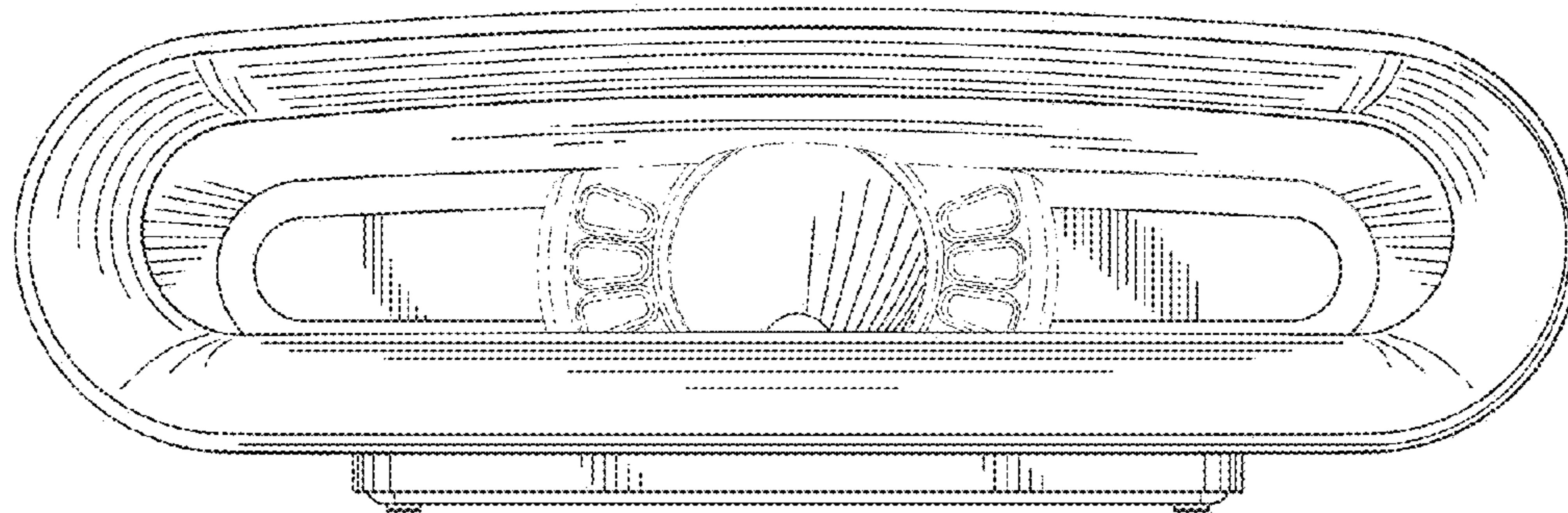

FIG.13

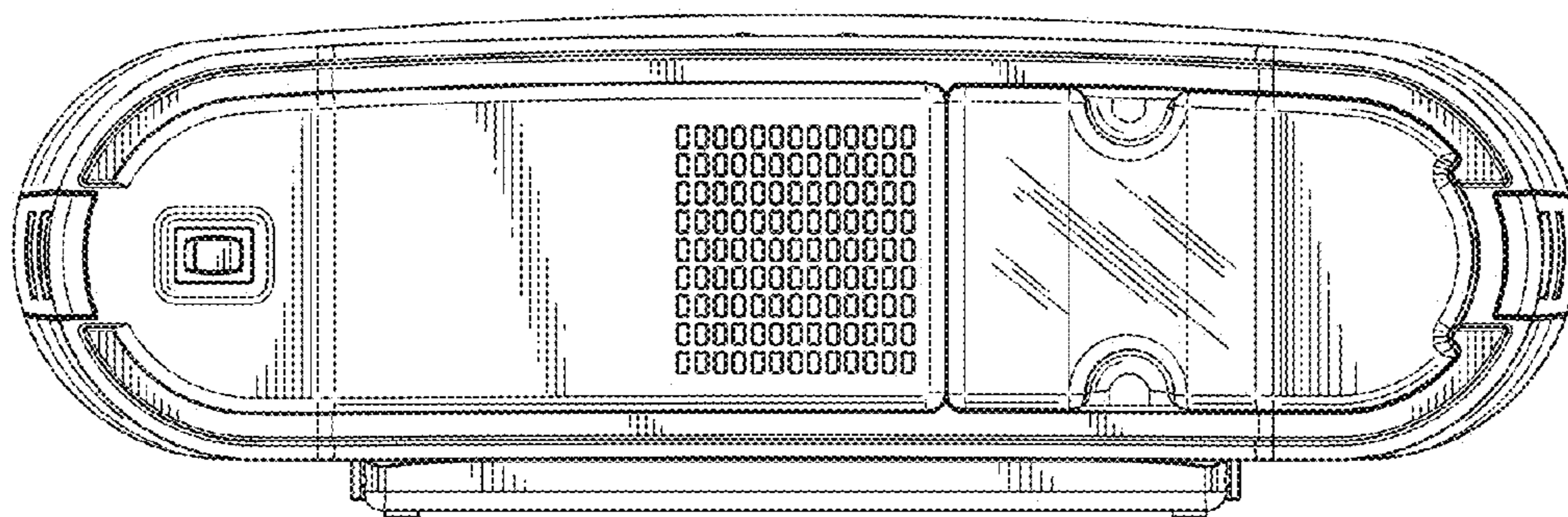

FIG.14