



US00D714896S

(12) **United States Design Patent**  
**Brookshire et al.**

(10) **Patent No.:** **US D714,896 S**  
(45) **Date of Patent:** **\*\* \*Oct. 7, 2014**

(54) **GOLF CLUB HEAD**

(71) Applicant: **Callaway Golf Company**, Carlsbad, CA (US)

(72) Inventors: **Catherine Brookshire**, Escondido, CA (US); **Matthew S. Hoffmeyer**, Carlsbad, CA (US)

(73) Assignee: **Callaway Golf Company**, Carlsbad, CA (US)

(\* ) Notice: This patent is subject to a terminal disclaimer.

(\*\*) Term: **14 Years**

(21) Appl. No.: **29/470,536**

(22) Filed: **Oct. 22, 2013**

(51) **LOC (10) Cl.** ..... **21-02**

(52) **U.S. Cl.**  
USPC ..... **D21/759**

(58) **Field of Classification Search**  
USPC ..... D21/733, 752, 759; 473/324–331, 473/343–346  
See application file for complete search history.

(56) **References Cited**

**U.S. PATENT DOCUMENTS**

D590,037 S \* 4/2009 Ruggiero et al. .... D21/759

D594,521 S \* 6/2009 Jertson et al. .... D21/759  
D637,671 S \* 5/2011 Kim et al. .... D21/752  
D652,095 S \* 1/2012 Kim ..... D21/752  
D663,370 S \* 7/2012 Kim et al. .... D21/752  
D669,547 S \* 10/2012 Kim et al. .... D21/752  
D686,291 S \* 7/2013 Foster ..... D21/759

\* cited by examiner

*Primary Examiner* — Mitchell Siegel

(74) *Attorney, Agent, or Firm* — Rebecca Hanovice; Michael A. Catania; Sonia Lari

(57) **CLAIM**

The ornamental design for a golf club head, as shown and described.

**DESCRIPTION**

FIG. 1 is a rear perspective view of the golf club head of the present invention;  
FIG. 2 is a rear elevational view thereof;  
FIG. 3 is a front elevational view thereof;  
FIG. 4 right side elevational view thereof;  
FIG. 5 is a left side elevational view thereof;  
FIG. 6 is a top plan view thereof; and,  
FIG. 7 is a bottom plan view thereof.  
The broken lines are included for the purpose of illustration only and form no part of the claimed design.

**1 Claim, 8 Drawing Sheets**

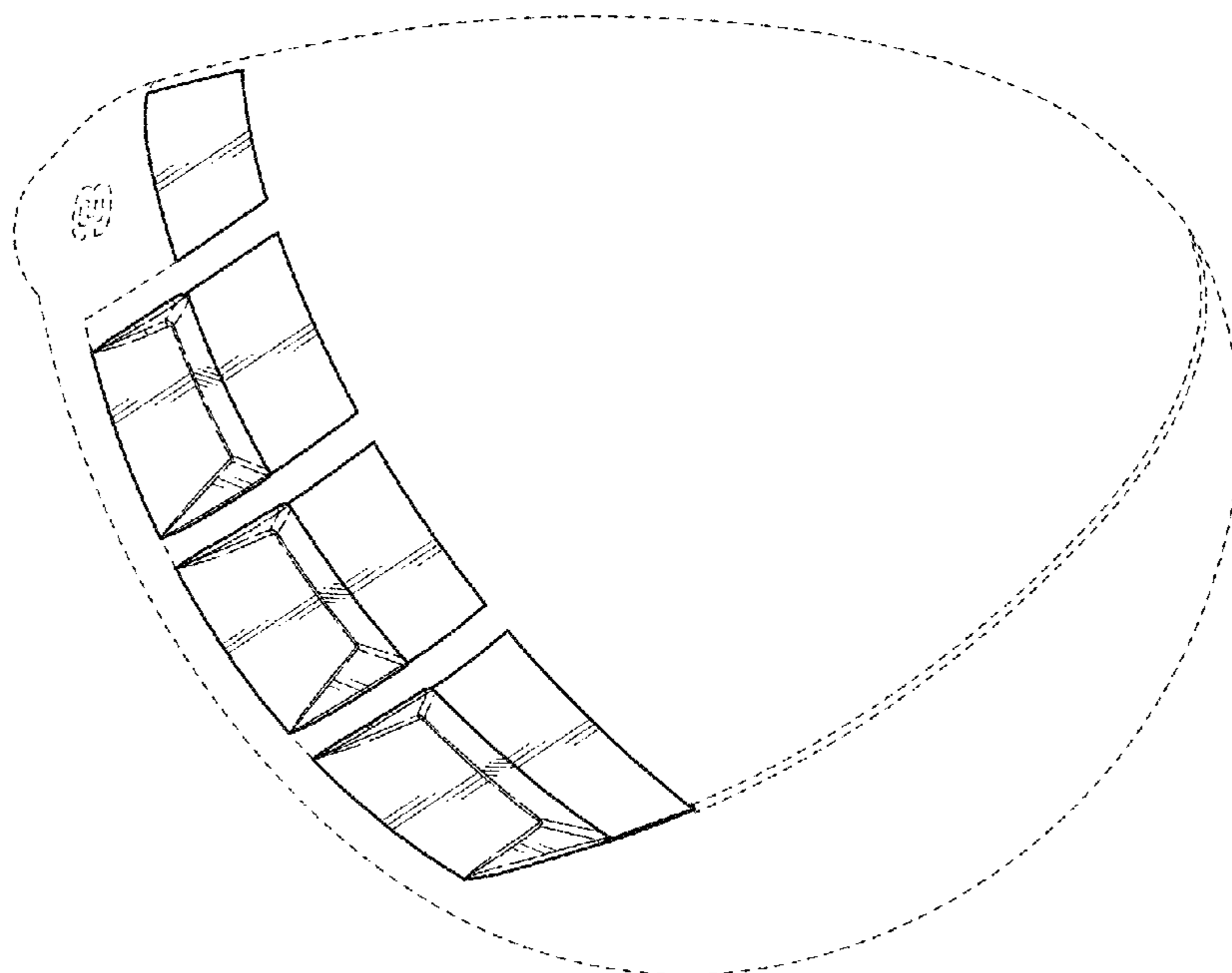

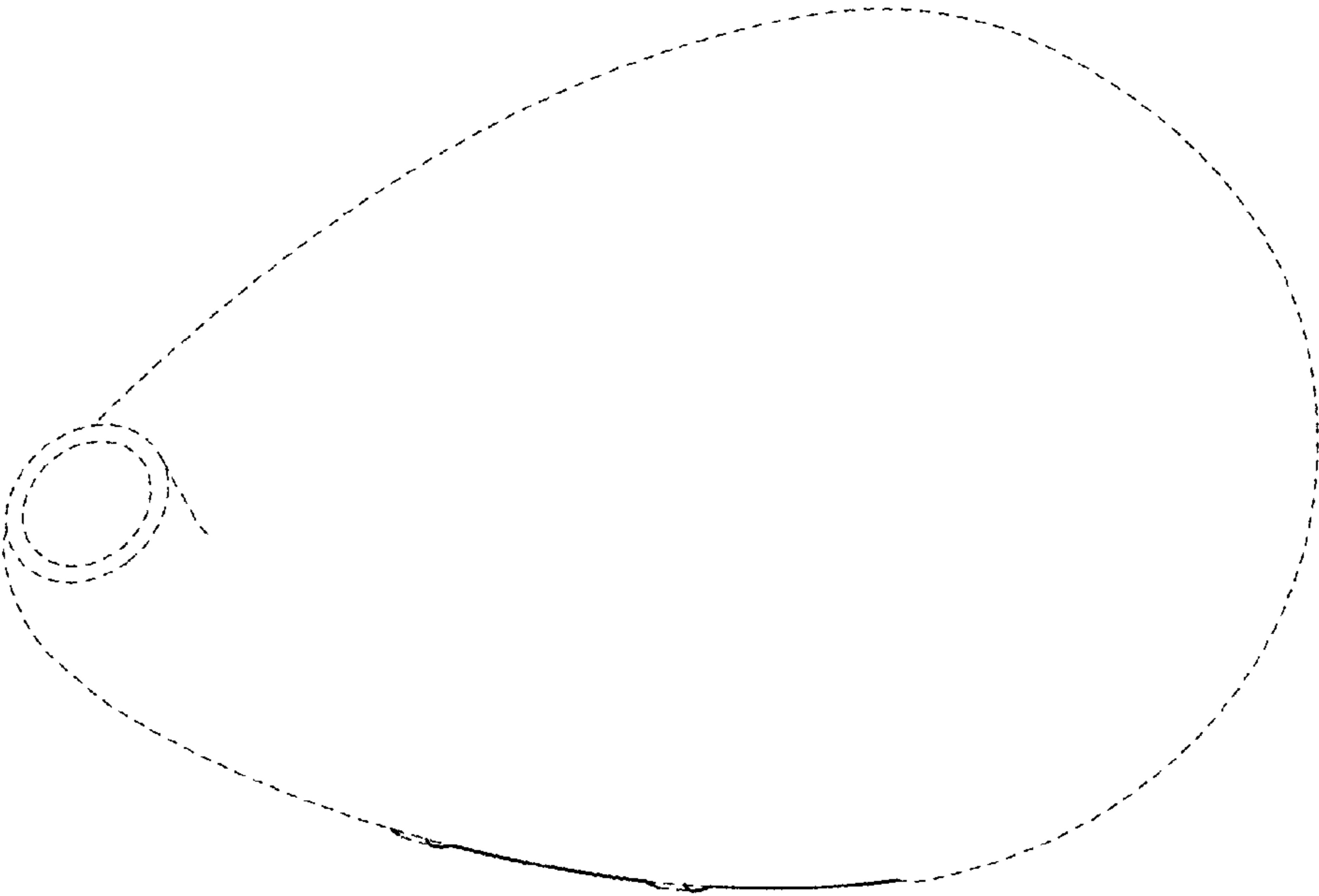

FIG. 1

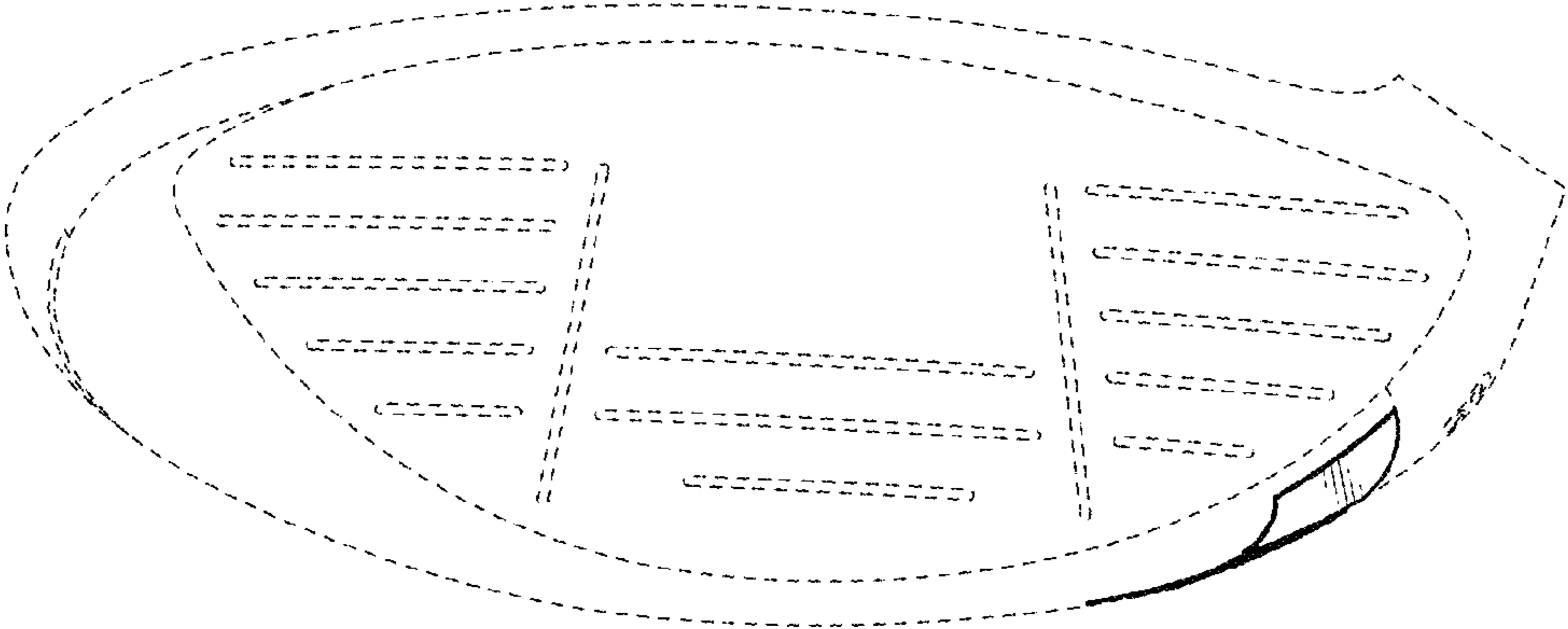

FIG. 2

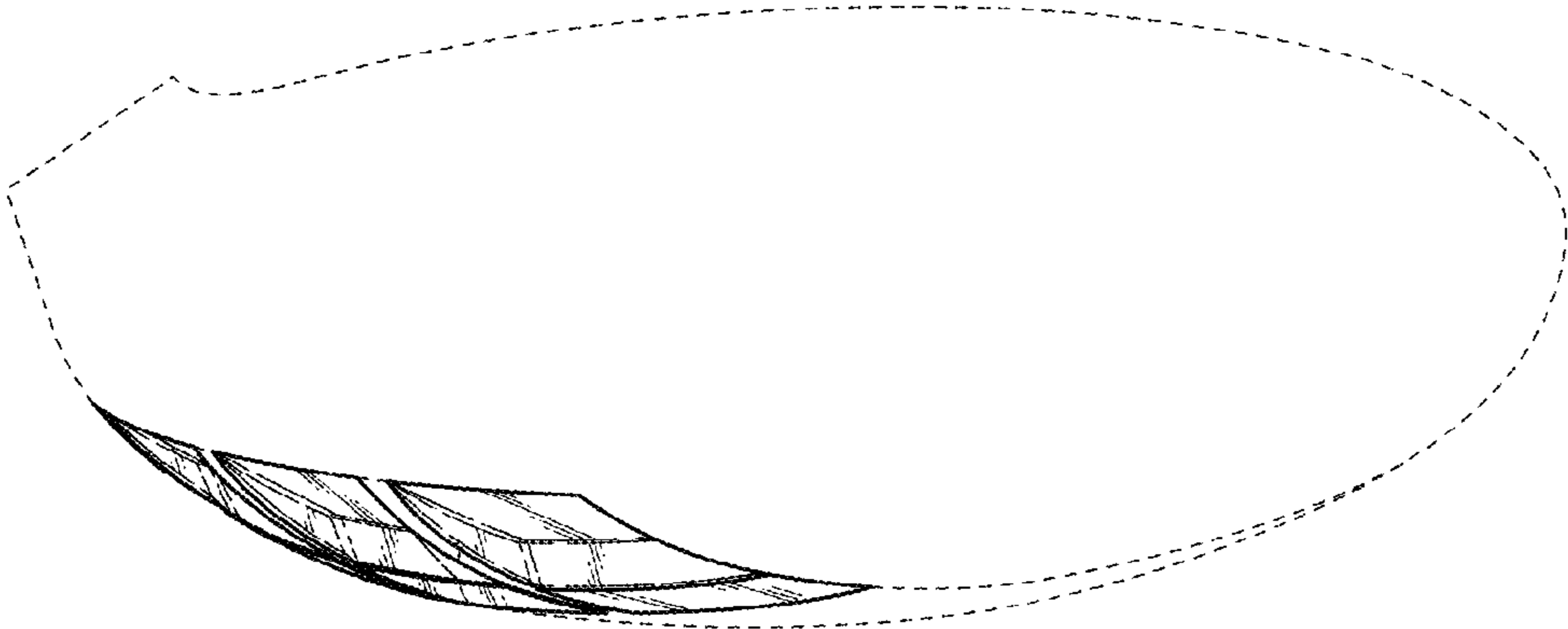

FIG. 3

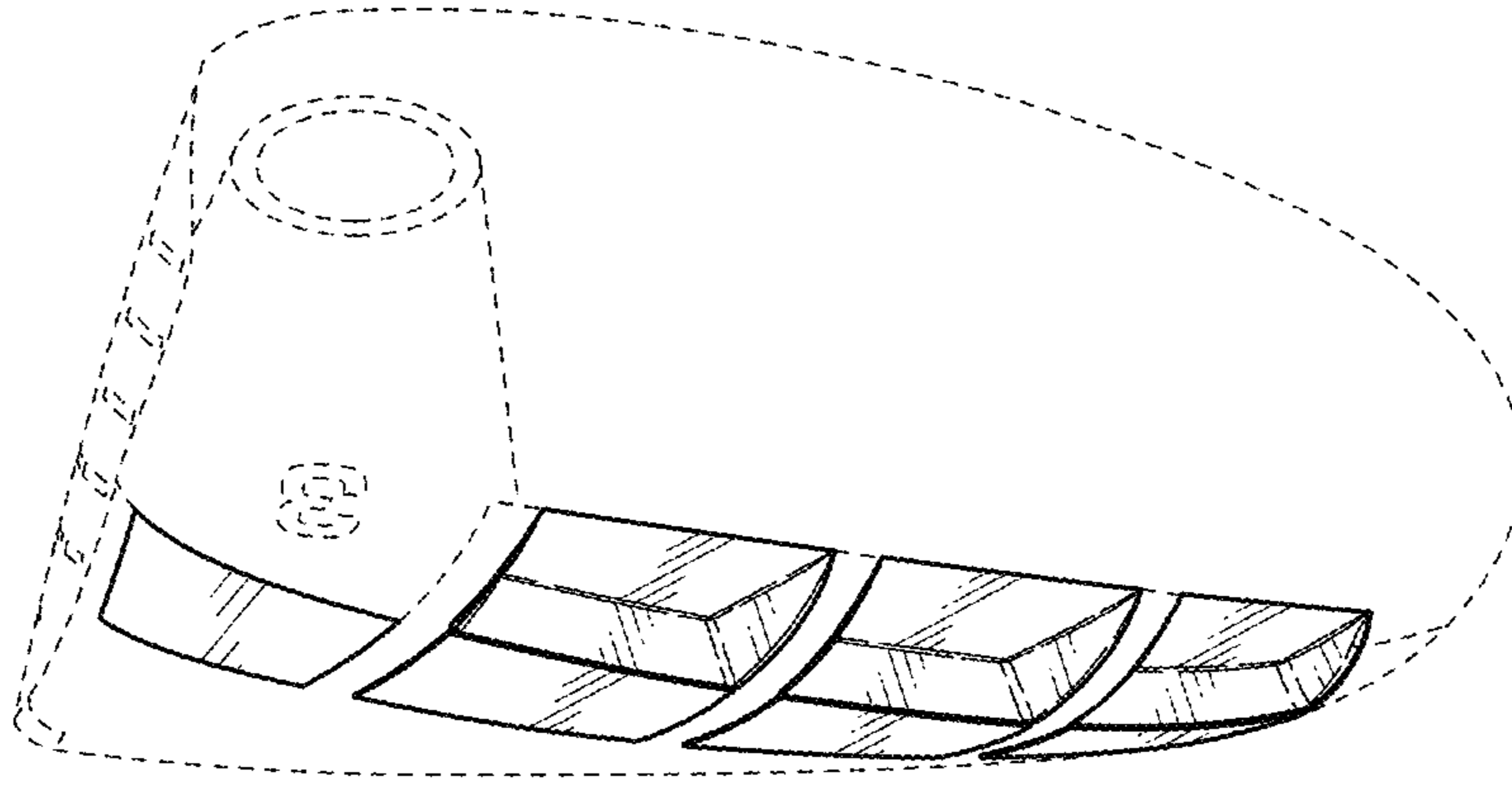

FIG. 4

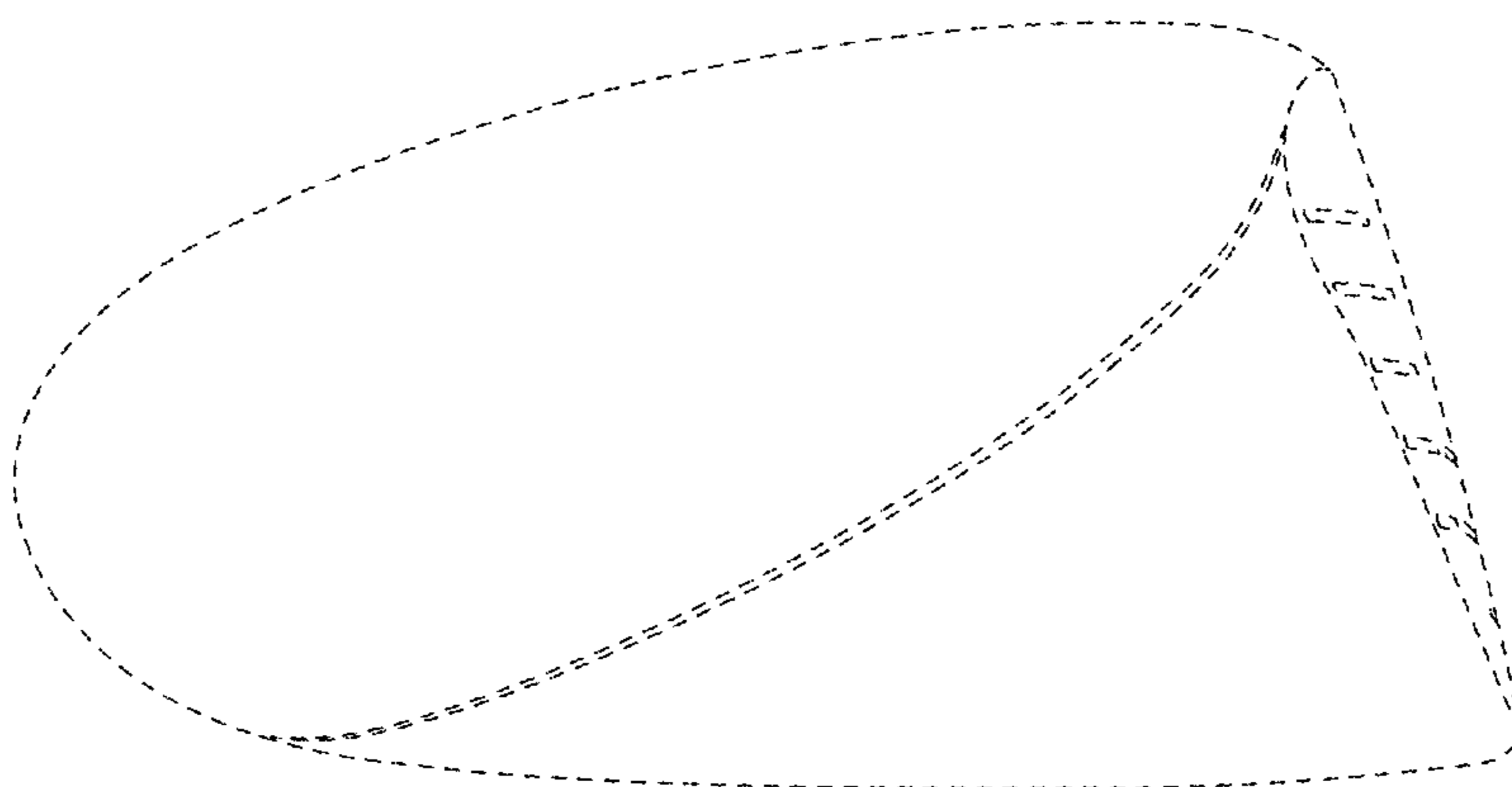

FIG. 5

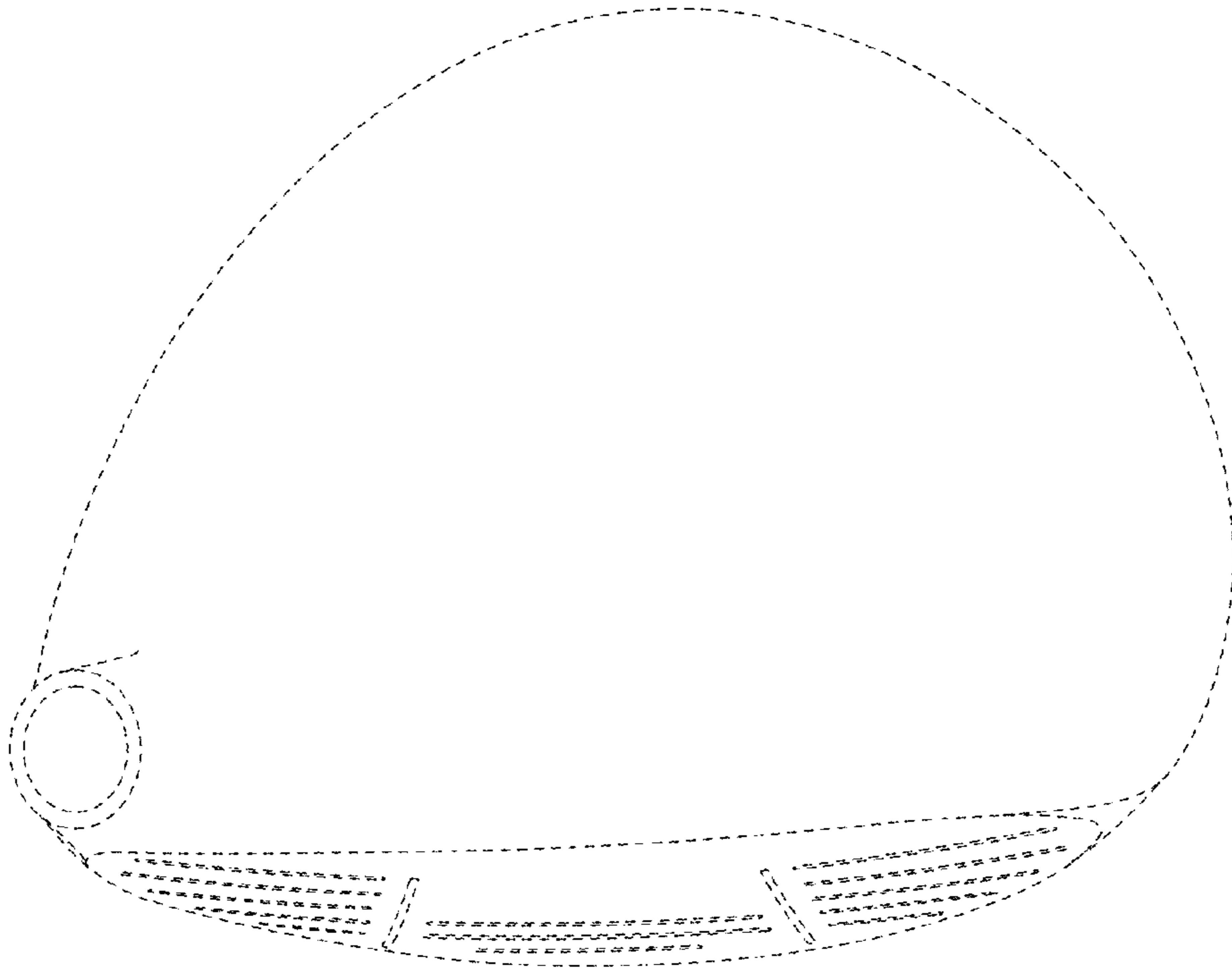

FIG. 6

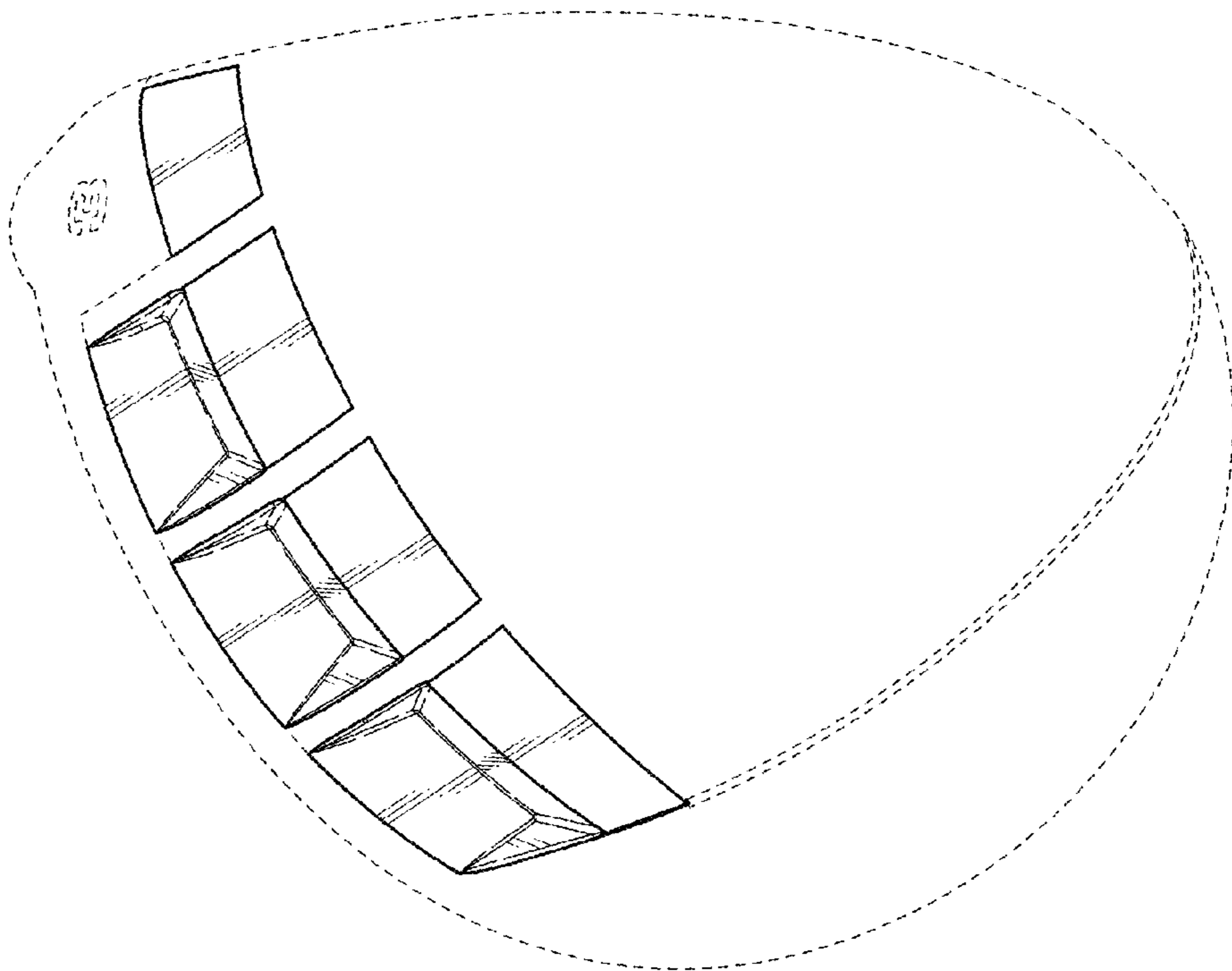

FIG. 7

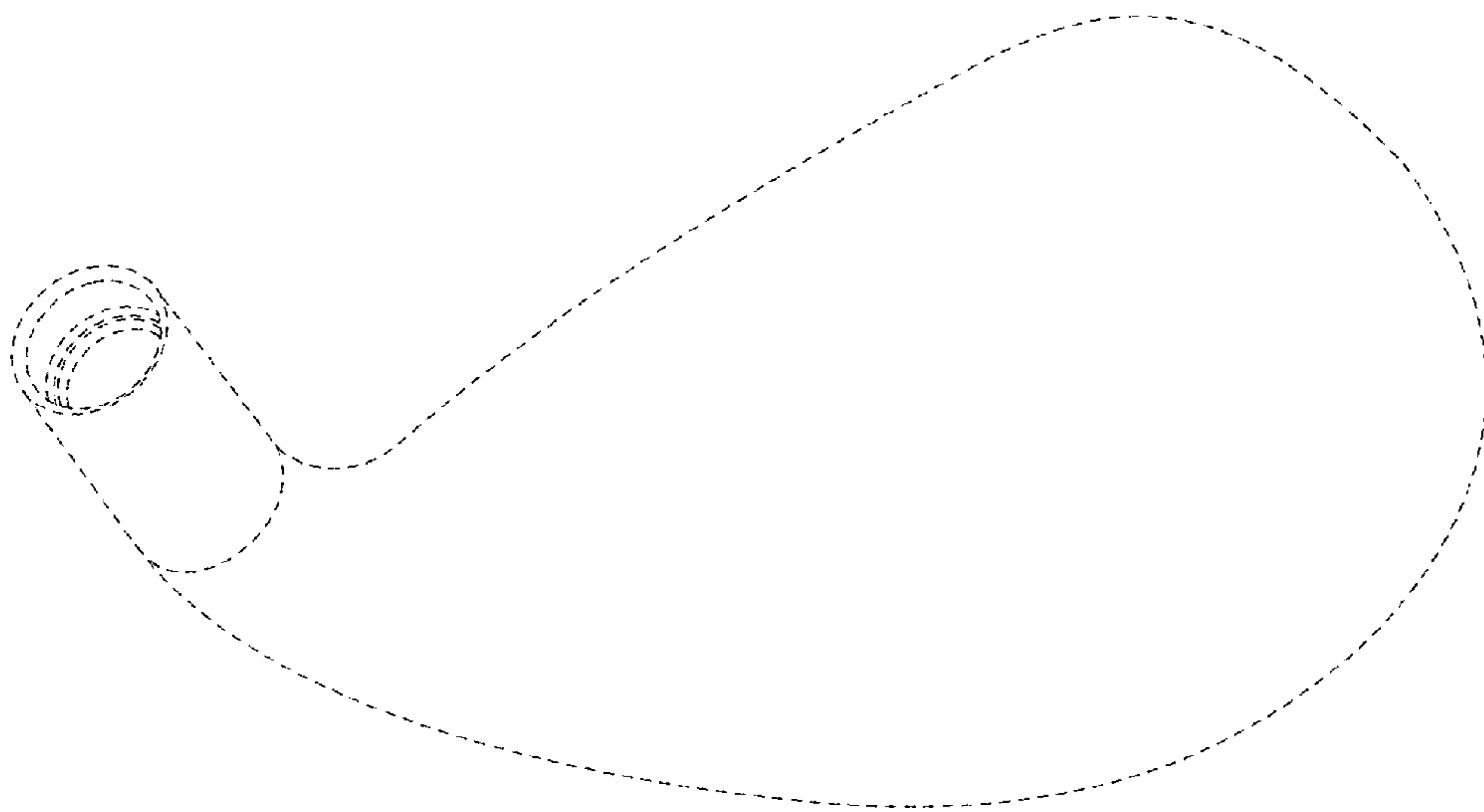

FIG. 8

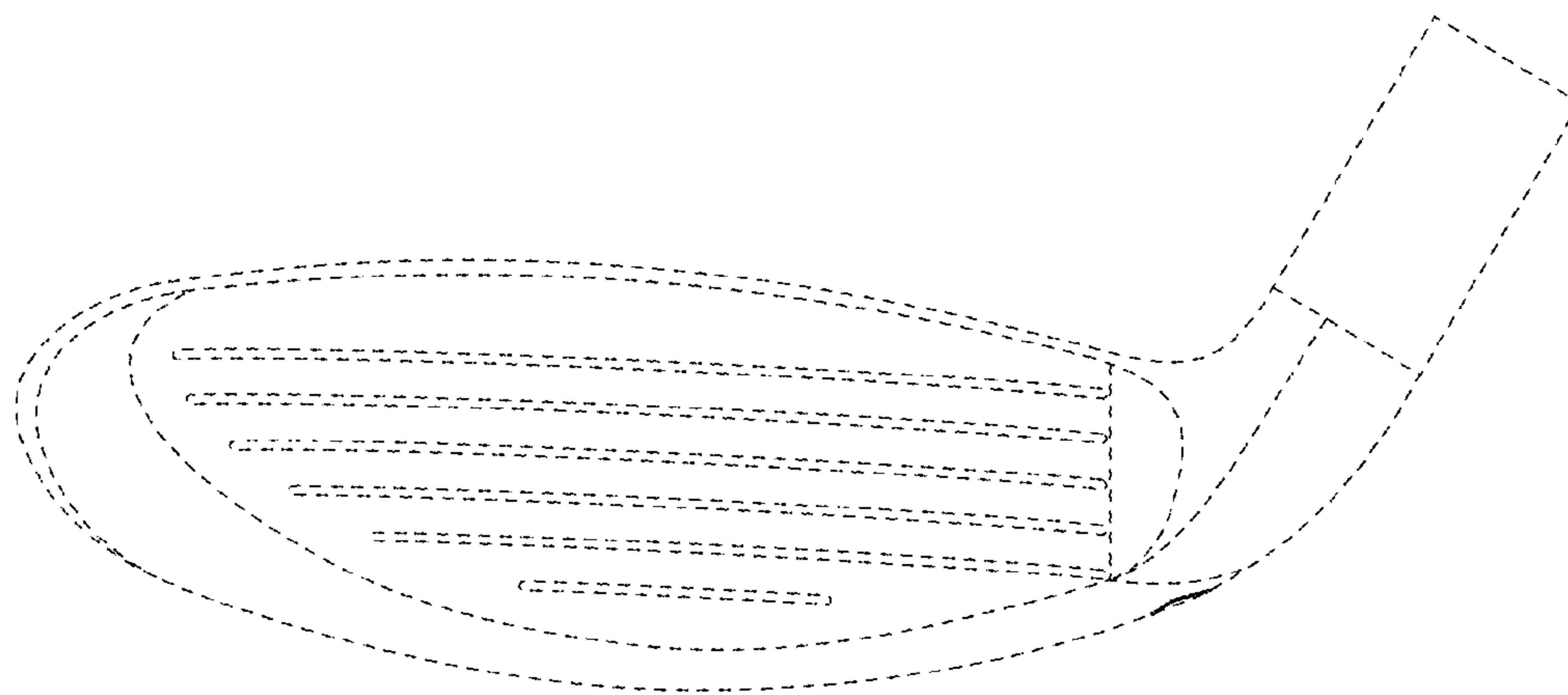

FIG. 9

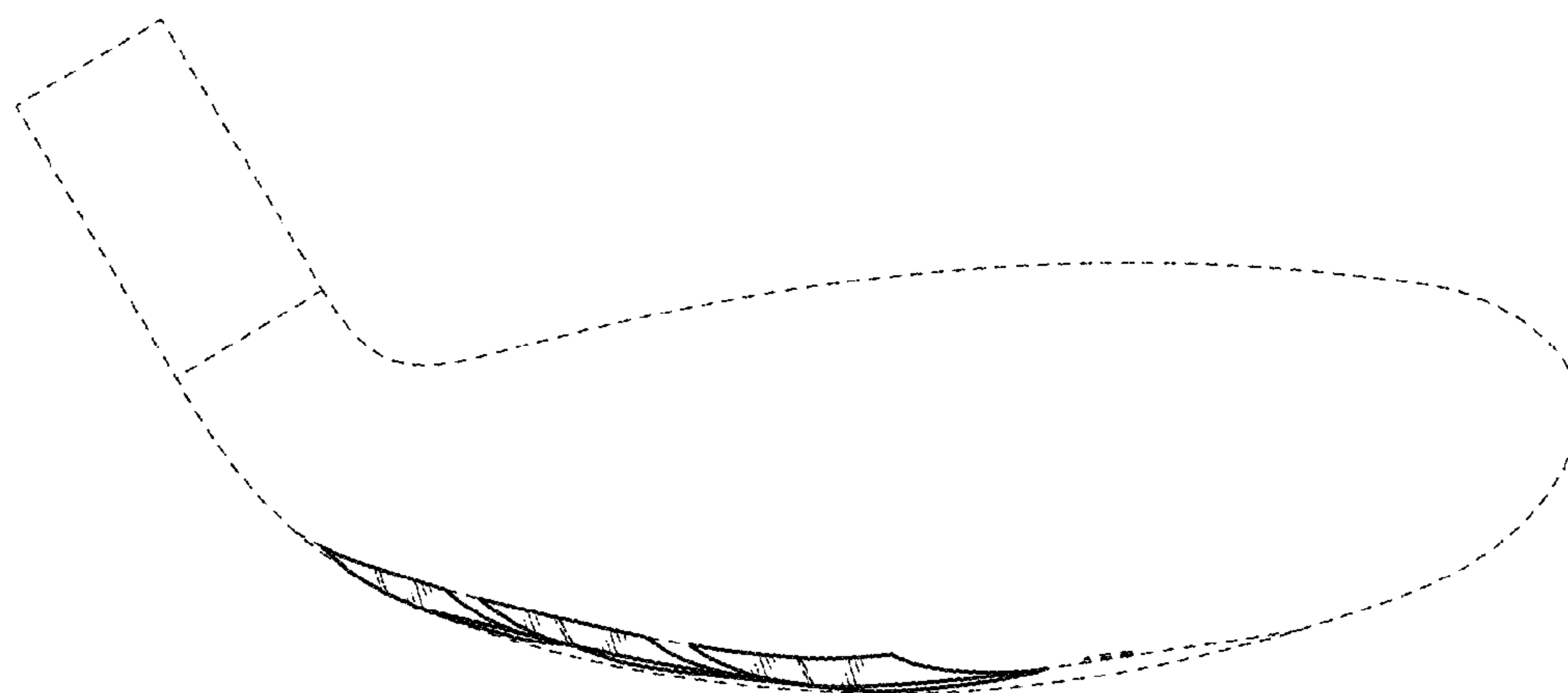

FIG. 10

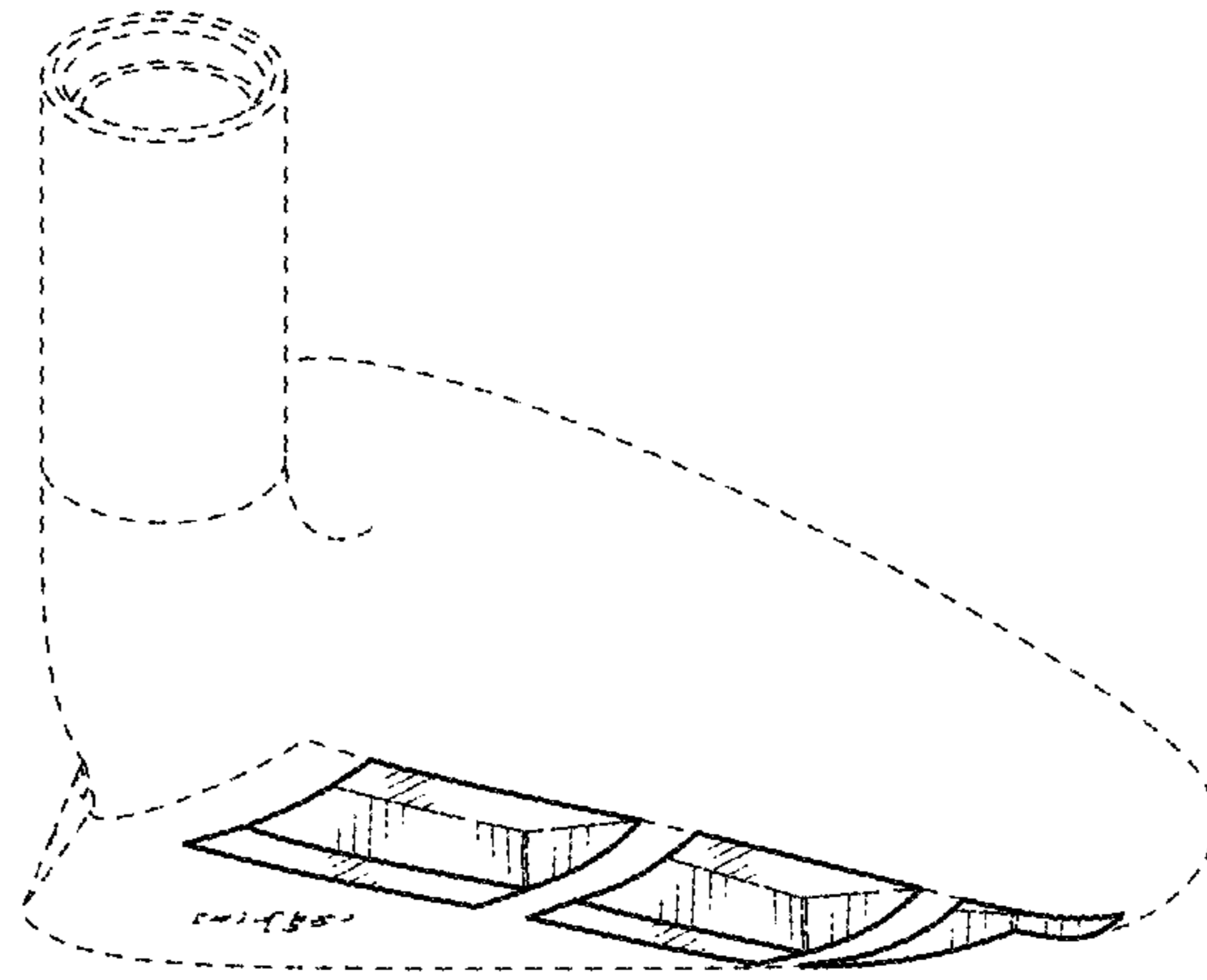

FIG. 11

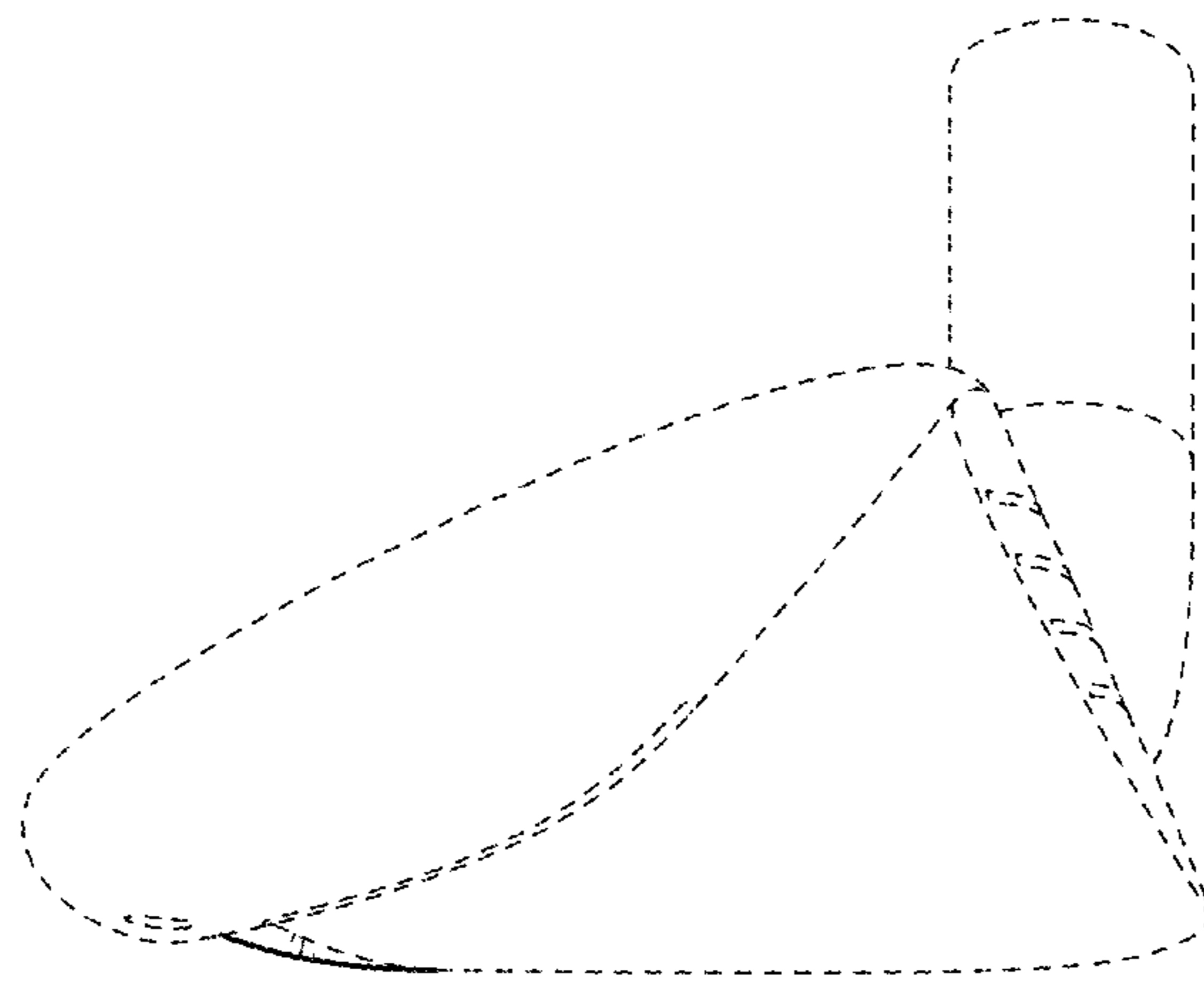

FIG. 12



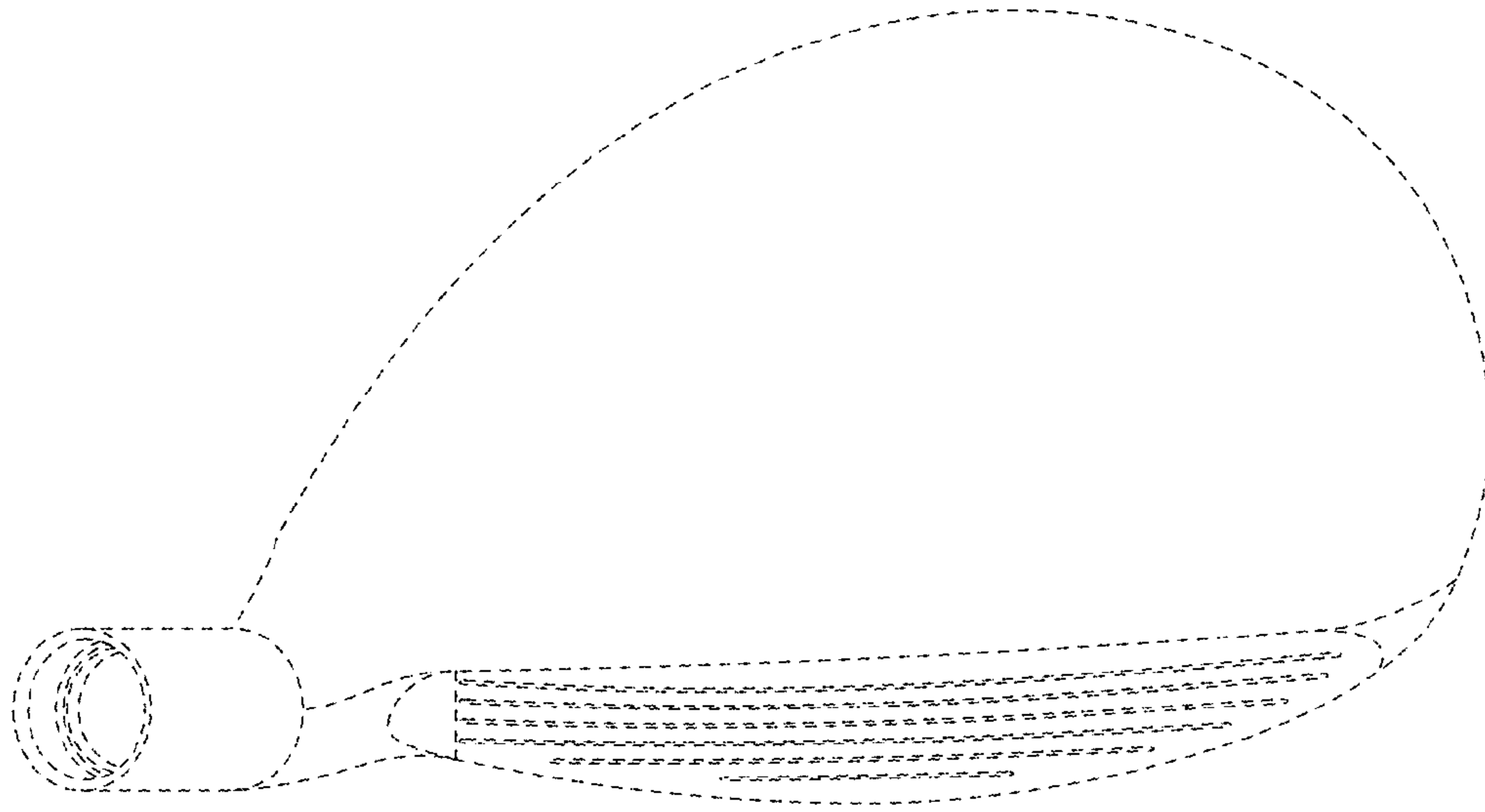

FIG. 13

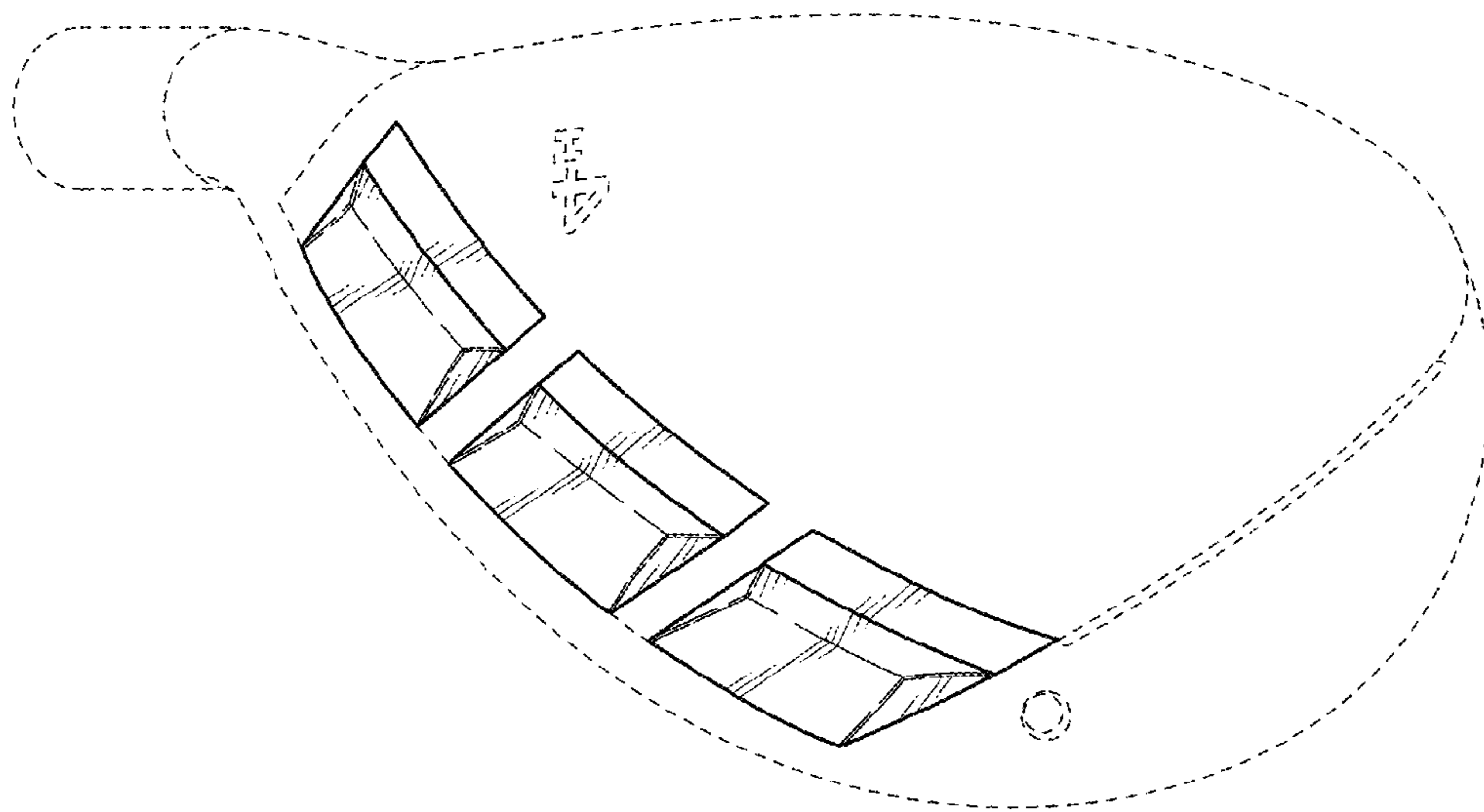

FIG. 14