



US00D714863S

(12) **United States Design Patent**
Borkovec et al.

(10) **Patent No.:** **US D714,863 S**
(45) **Date of Patent:** **** Oct. 7, 2014**

- (54) **CARTRIDGE FOR INK**
- (71) Applicant: **GFI Innovations, Inc.**, Gurnee, IL (US)
- (72) Inventors: **John Borkovec**, Riverside, IL (US);
Justin Echterling, Gurnee, IL (US)
- (73) Assignee: **GFI Innovations, Inc.**, Gurnee, IL (US)
- (**) Term: **14 Years**
- (21) Appl. No.: **29/476,071**
- (22) Filed: **Dec. 10, 2013**
- (51) **LOC (10) Cl.** **18-02**
- (52) **U.S. Cl.**
USPC **D18/56**
- (58) **Field of Classification Search**
USPC D18/12, 40, 43, 56; 360/132; 399/260,
399/262, 116, 119; 347/86, 87, 222;
D28/76, 88; D9/500, 503-505
See application file for complete search history.

7,263,310	B2 *	8/2007	Baek et al.	399/116
D559,902	S *	1/2008	Park et al.	D18/56
D583,862	S *	12/2008	Park et al.	D18/56
D610,607	S *	2/2010	Kachi et al.	D18/56
D634,647	S *	3/2011	Helmenstein	D9/724
8,099,020	B2 *	1/2012	Mase et al.	399/119
D671,835	S *	12/2012	Penafiel Saez	D9/500
8,371,763	B2 *	2/2013	Kim et al.	400/88
D697,802	S *	1/2014	Lane	D9/500

* cited by examiner

Primary Examiner — Cathy A MacCormac
(74) *Attorney, Agent, or Firm* — Banner & Witcoff, Ltd.

(57) **CLAIM**
The ornamental design for a cartridge for ink, as shown and described.

DESCRIPTION

FIG. 1 is a front, top perspective view of a cartridge for ink showing my new design, wherein selected unclaimed detail is omitted for clarity;
 FIG. 2 is a front view thereof;
 FIG. 3 is a right side view thereof;
 FIG. 4 is a rear view thereof;
 FIG. 5 is a left side view thereof;
 FIG. 6 is a top view thereof, wherein selected unclaimed detail is omitted for clarity;
 FIG. 7 is an exploded front, top, right perspective view thereof; and,
 FIG. 8 is an enlarged, partial, front, top perspective view of FIG. 1 showing the unclaimed detail omitted in FIG. 1.
 The evenly spaced broken lines are for illustration only and form no part of the claimed design. The line-dot-line broken lines represent a boundary of the claimed design, are for illustration only and form no part of the claimed design. The bottom is not shown and is not claimed.

1 Claim, 8 Drawing Sheets

(56) **References Cited**

U.S. PATENT DOCUMENTS

D113,416	S *	2/1939	Barrett	D9/500
3,454,207	A *	7/1969	Jackson	229/5.84
D223,899	S *	6/1972	Zundel	D9/503
4,688,926	A *	8/1987	Manno	399/260
D321,716	S *	11/1991	Kikuchi et al.	D18/43
5,280,324	A *	1/1994	Ono et al.	399/262
6,006,053	A *	12/1999	Ikehara	399/116
6,238,043	B1 *	5/2001	Silverbrook	347/86
D466,150	S *	11/2002	Matsumoto et al.	D18/56
D469,119	S *	1/2003	Shiba	D18/43
D496,684	S *	9/2004	Goldfain et al.	D18/56
D524,366	S *	7/2006	Arai et al.	D18/56
7,116,929	B2 *	10/2006	Yamada	399/262
7,165,833	B2 *	1/2007	Graham et al.	347/86
7,168,797	B2 *	1/2007	Arai et al.	347/86

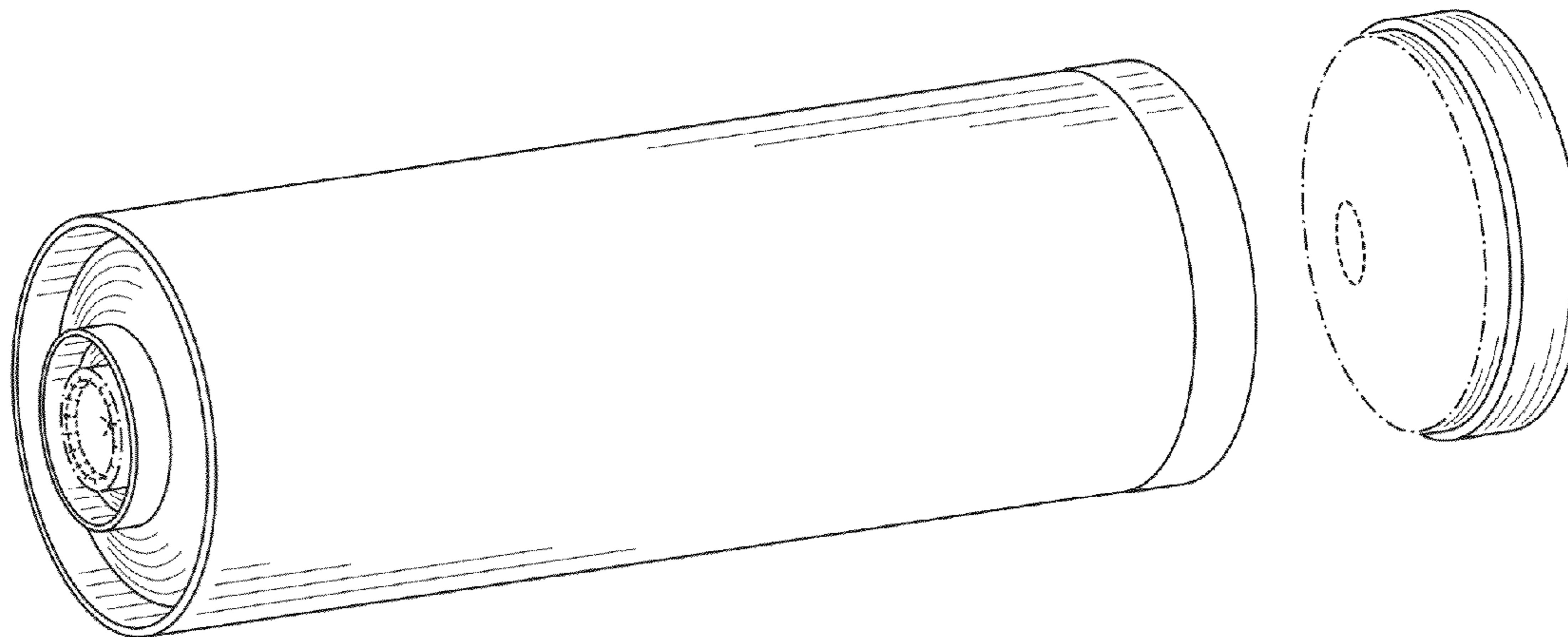

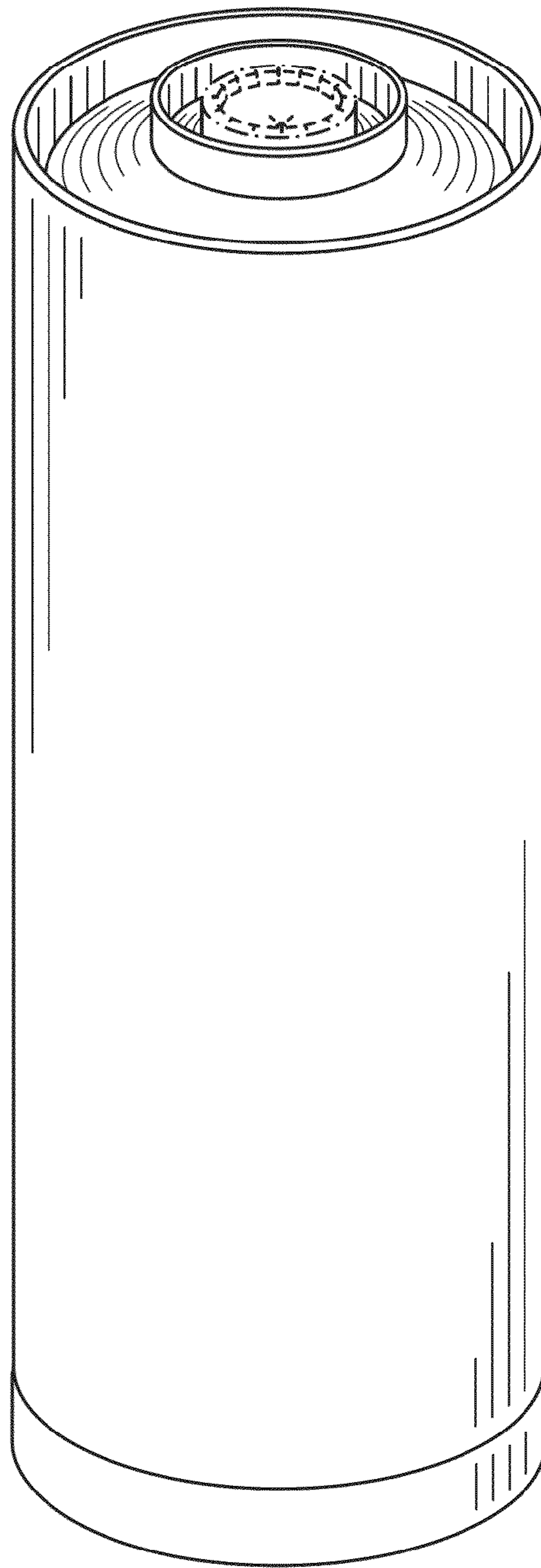

Fig. 1

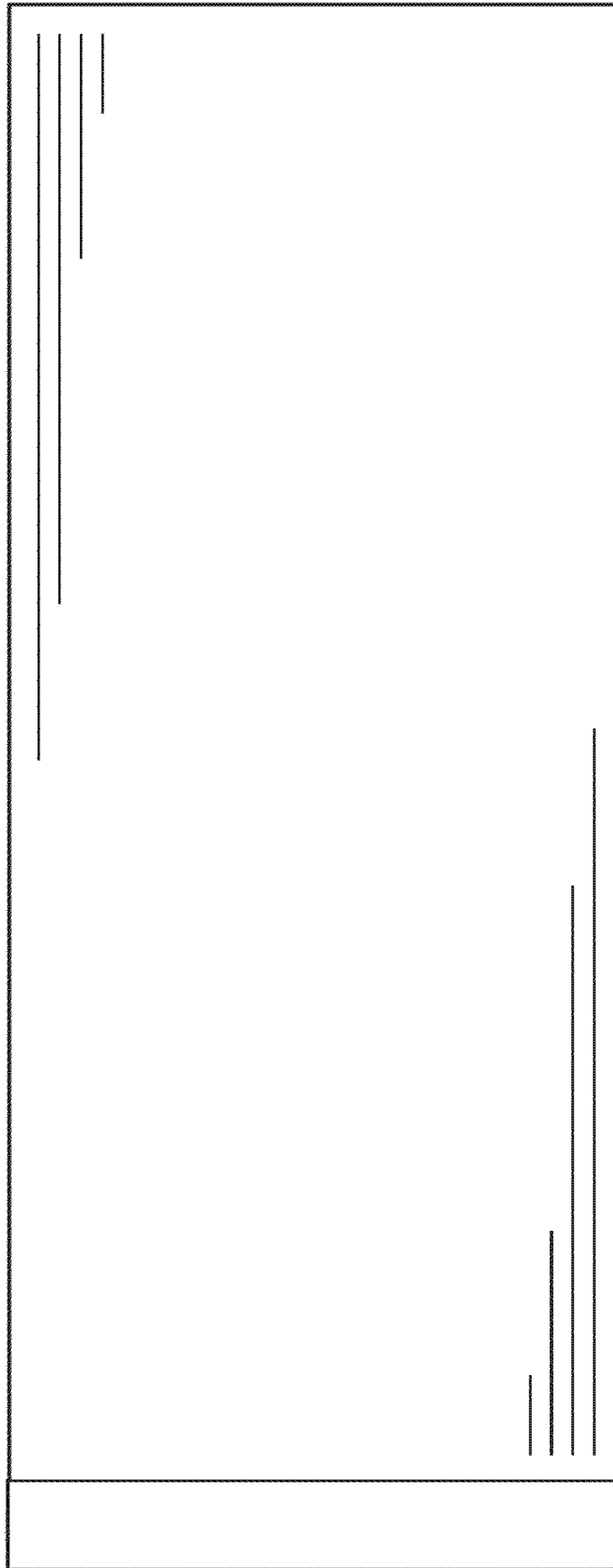

Fig. 2

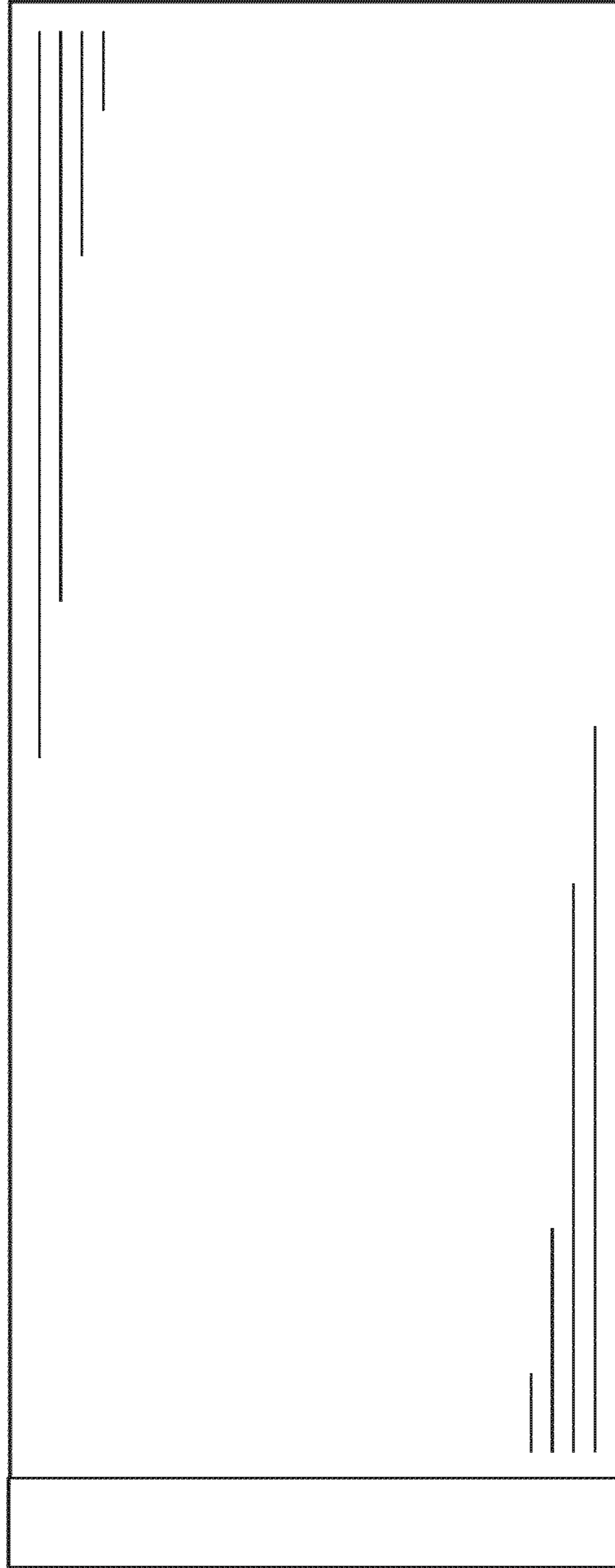

Fig. 3

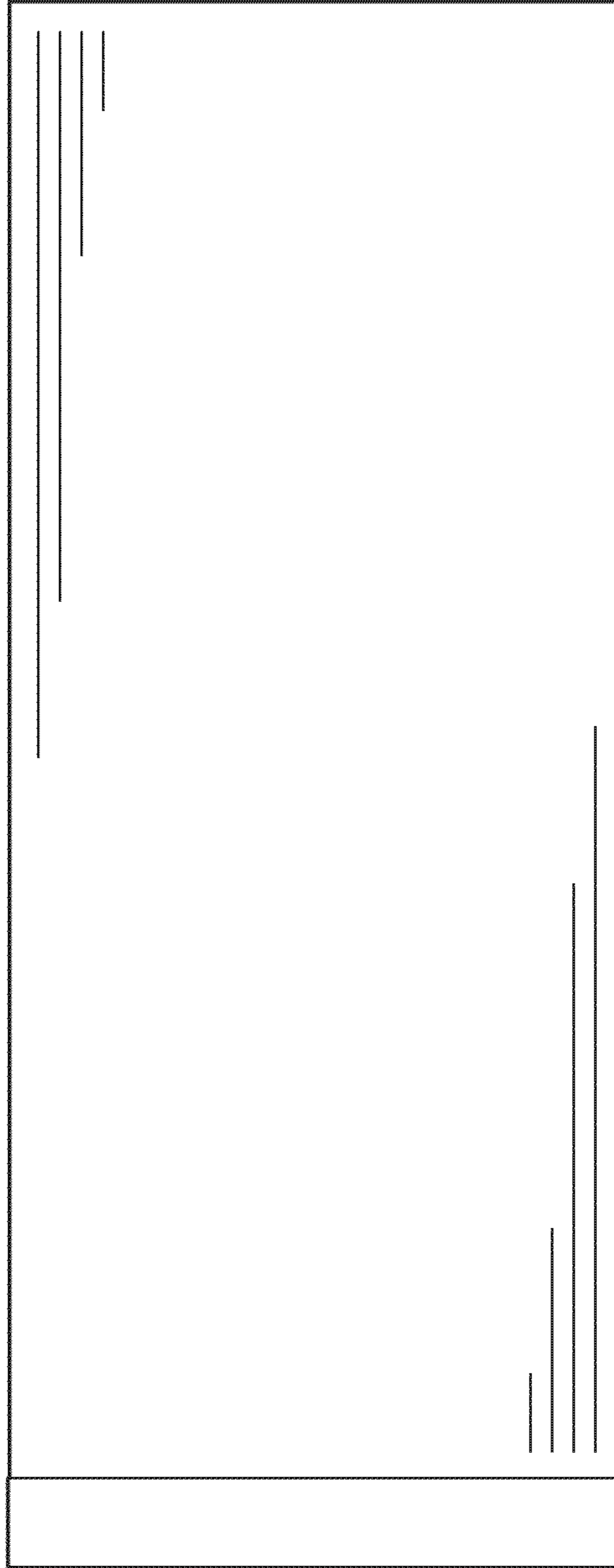

Fig. 4

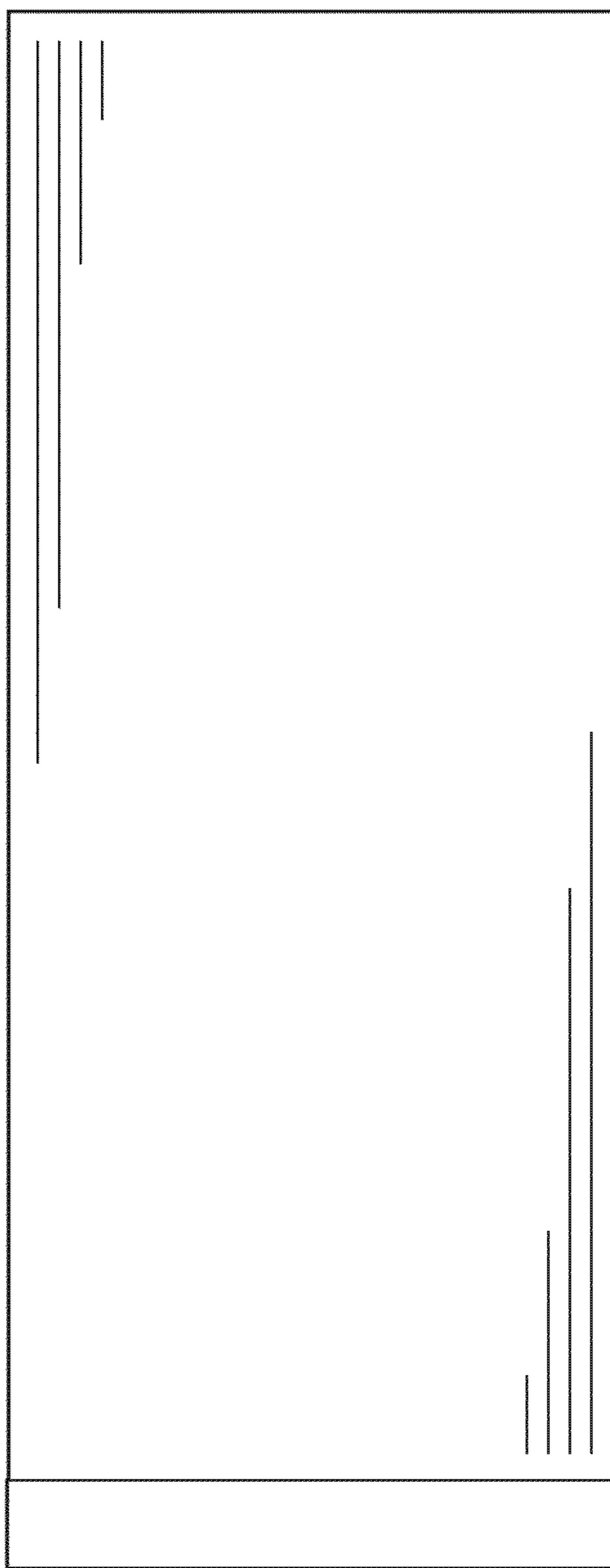

Fig. 5

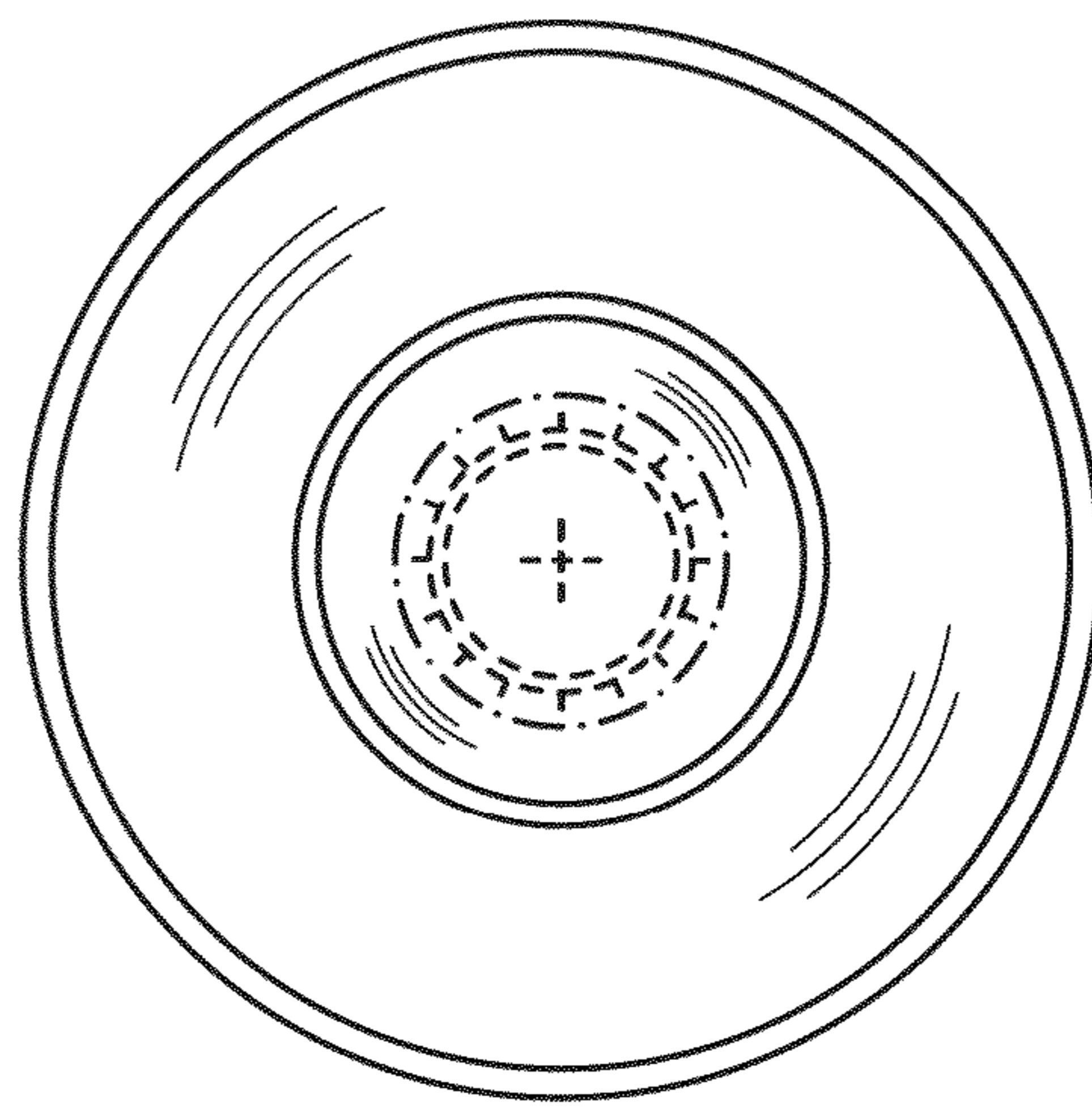

Fig. 6

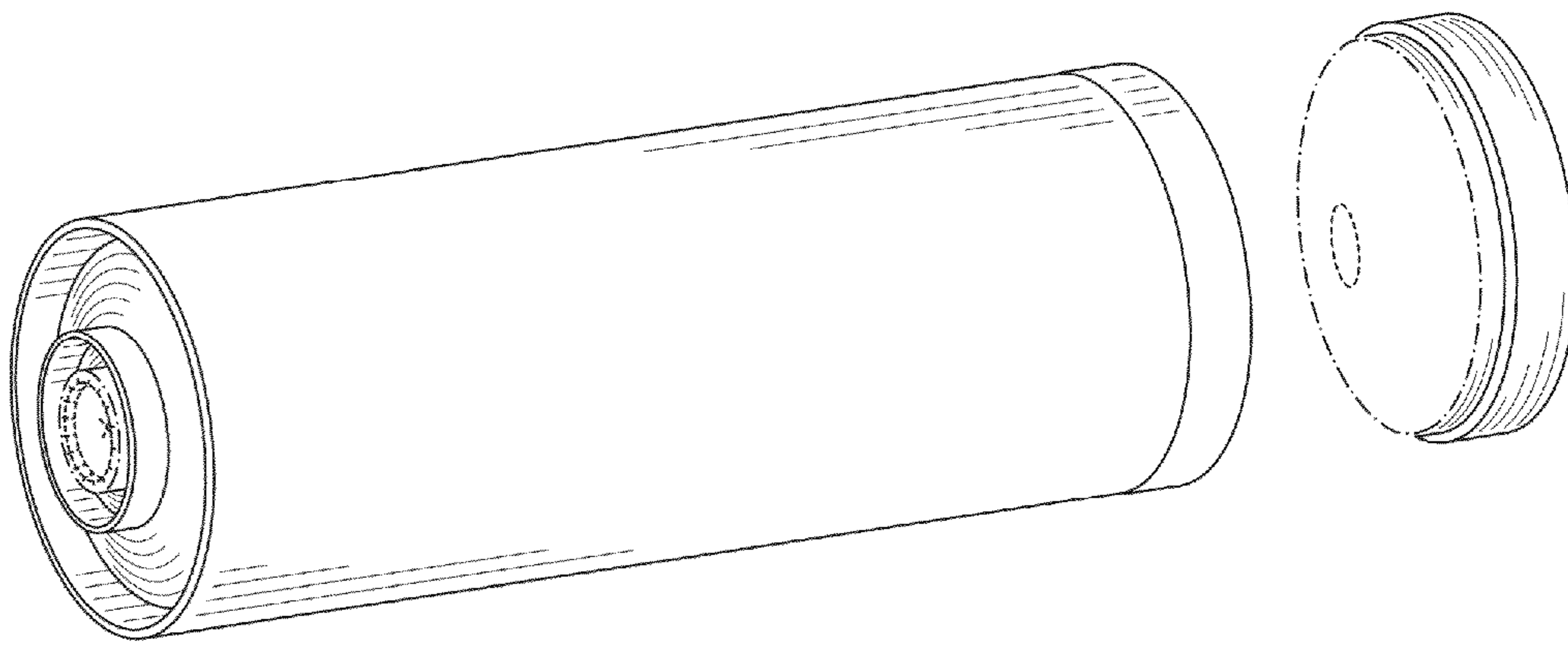

Fig. 7

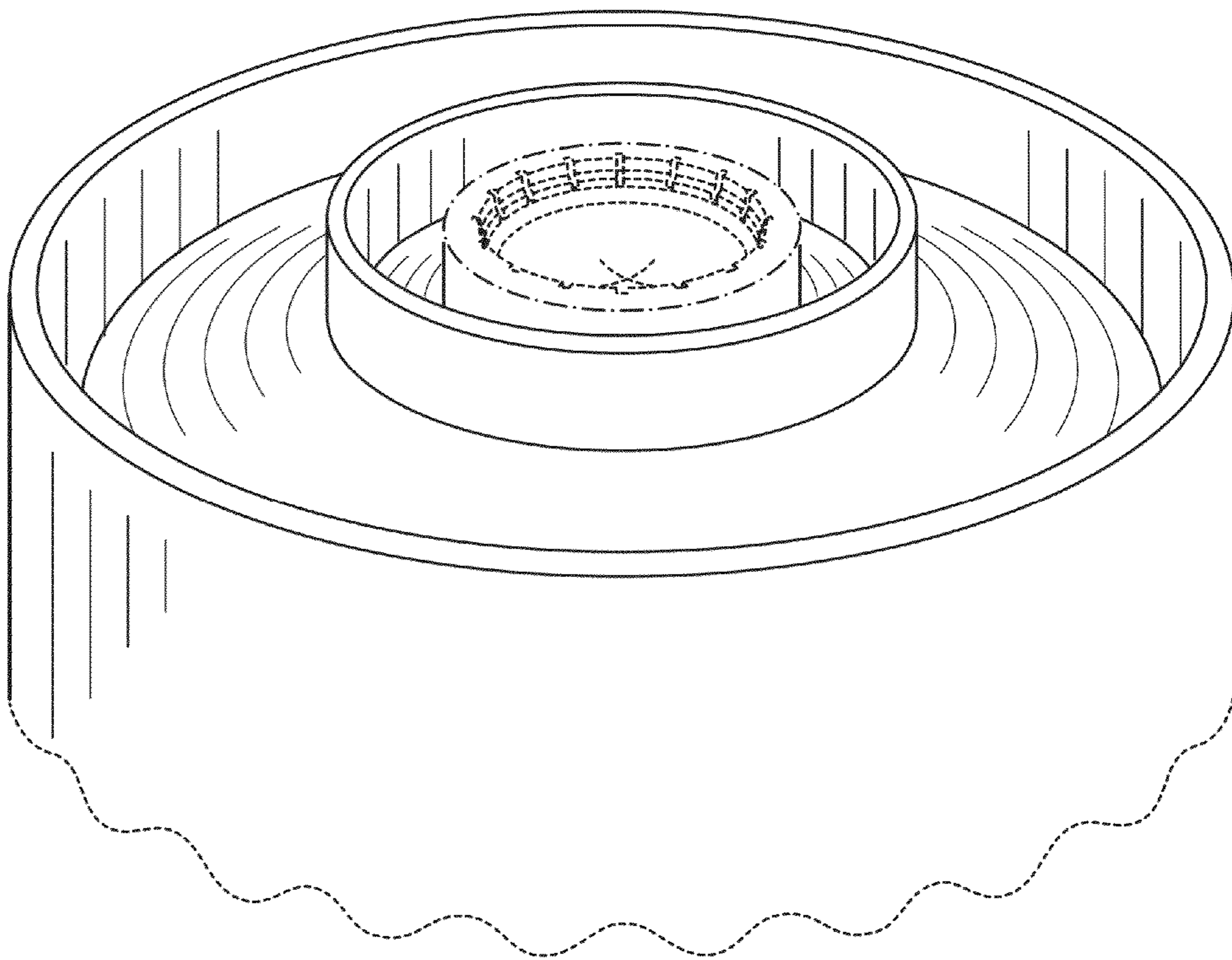

Fig. 8