



US00D714839S

(12) **United States Design Patent**
Jeon et al.

(10) **Patent No.:** **US D714,839 S**

(45) **Date of Patent:** **** Oct. 7, 2014**

(54) **REFRIGERATOR**

(71) Applicant: **Samsung Electronics Co., Ltd.**,
Suwon-si (KR)
(72) Inventors: **Sang-Woon Jeon**, Namyangju-si (KR);
Min-Hyong Boo, Seoul (KR);
Jae-Moon Lee, Seoul (KR)
(73) Assignee: **Samsung Electronics Co., Ltd.** (KR)

(**) Term: **14 Years**

(21) Appl. No.: **29/459,260**

(22) Filed: **Jun. 27, 2013**

(30) **Foreign Application Priority Data**

Dec. 28, 2012 (KR) 30-2012-0063024

(51) **LOC (10) Cl.** **15-07**

(52) **U.S. Cl.**
USPC **D15/86**

(58) **Field of Classification Search**
USPC D15/79-90; 62/440-449, 3.1, 3.6, 3.64,
62/246-255, 337; 312/138.1, 139.2, 236,
312/400-408, 352

See application file for complete search history.

(56) **References Cited**

U.S. PATENT DOCUMENTS

D601,596 S *	10/2009	Yoon et al.	D15/85
D633,114 S *	2/2011	Seo et al.	D15/86
D641,384 S *	7/2011	Yang et al.	D15/86
D660,325 S *	5/2012	Yang et al.	D15/86
D674,417 S *	1/2013	Seo et al.	D15/86
D690,329 S *	9/2013	Seo et al.	D15/86
D692,929 S *	11/2013	Seo et al.	D15/86
D703,244 S *	4/2014	Seo et al.	D15/86
D703,245 S *	4/2014	Seo et al.	D15/86

* cited by examiner

Primary Examiner — Thomas Johannes
Assistant Examiner — Khawaja Anwar
(74) *Attorney, Agent, or Firm* — Cantor Colburn LLP

(57) **CLAIM**

We claim, the ornamental design for a refrigerator, as shown and described.

DESCRIPTION

FIG. 1 is a perspective view of a refrigerator, showing our new design;
FIG. 2 is a front elevation view thereof;
FIG. 3 is a rear elevation view thereof;
FIG. 4 is a side elevation view thereof;
FIG. 5 is a another side elevation view thereof;
FIG. 6 is a top plan view thereof; and,
FIG. 7 is a bottom plan view thereof.
The broken lines in the drawings show unclaimed environment only and form no part of the claimed design.

1 Claim, 6 Drawing Sheets

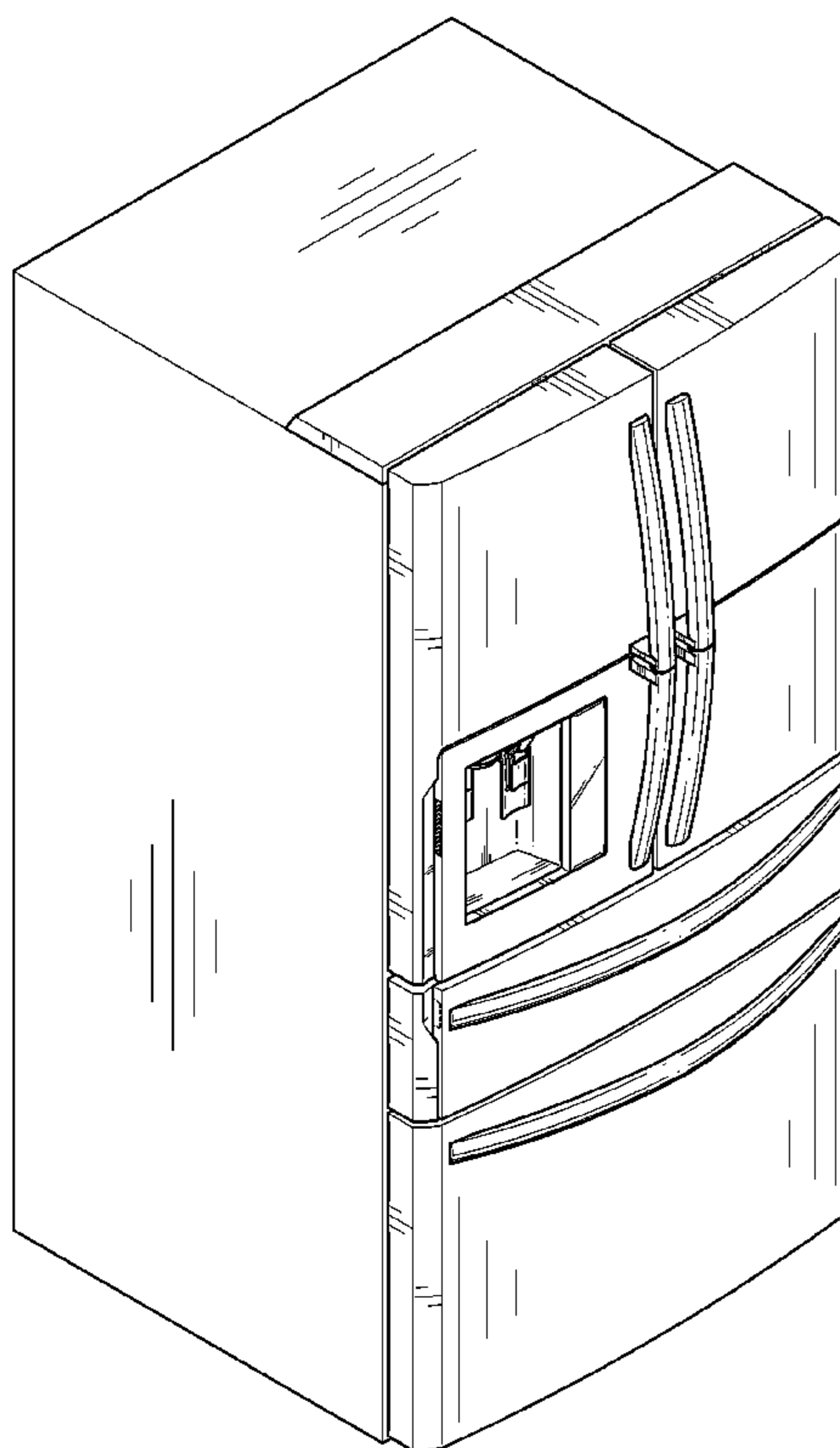

FIG. 1

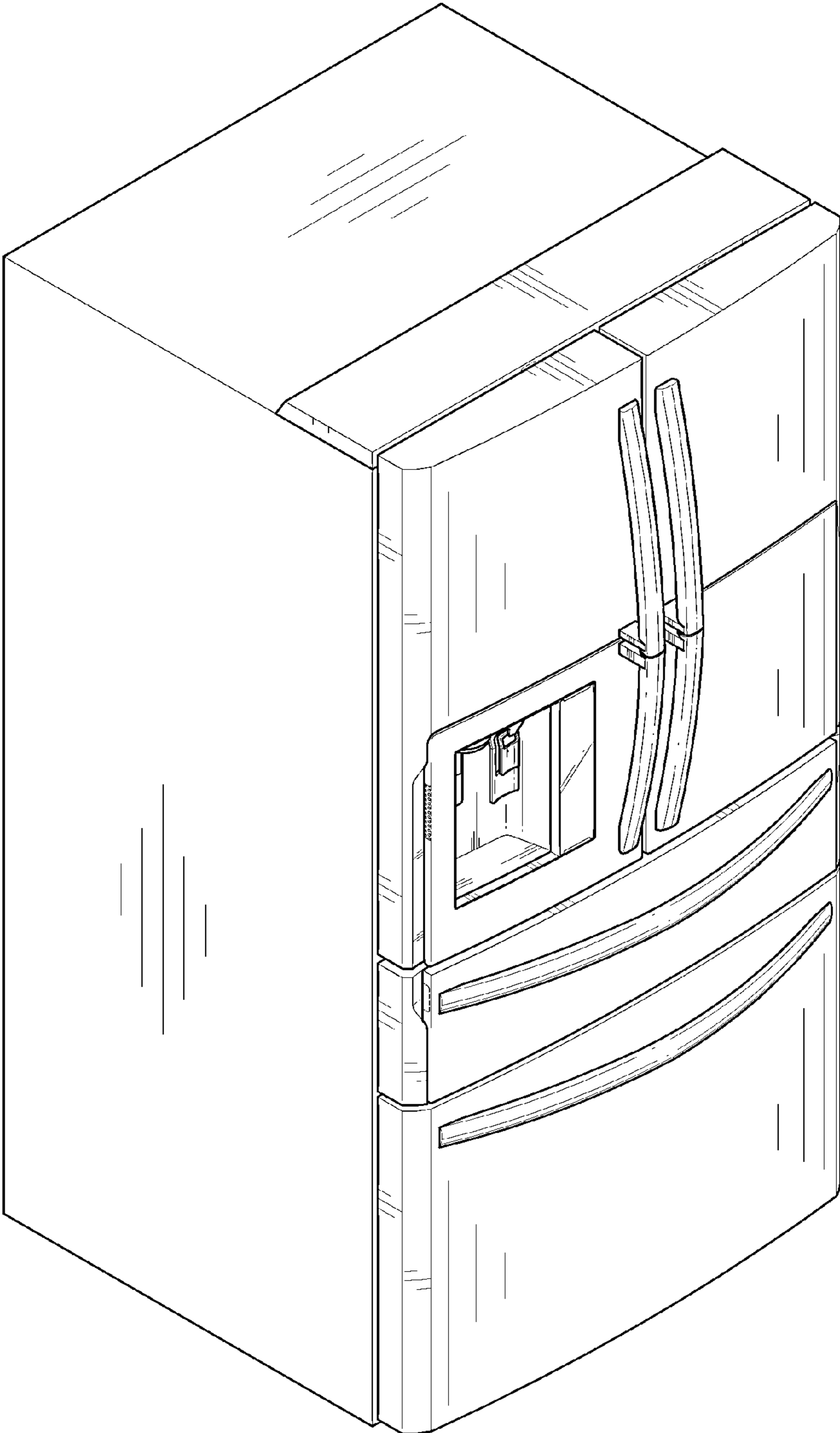

FIG. 2

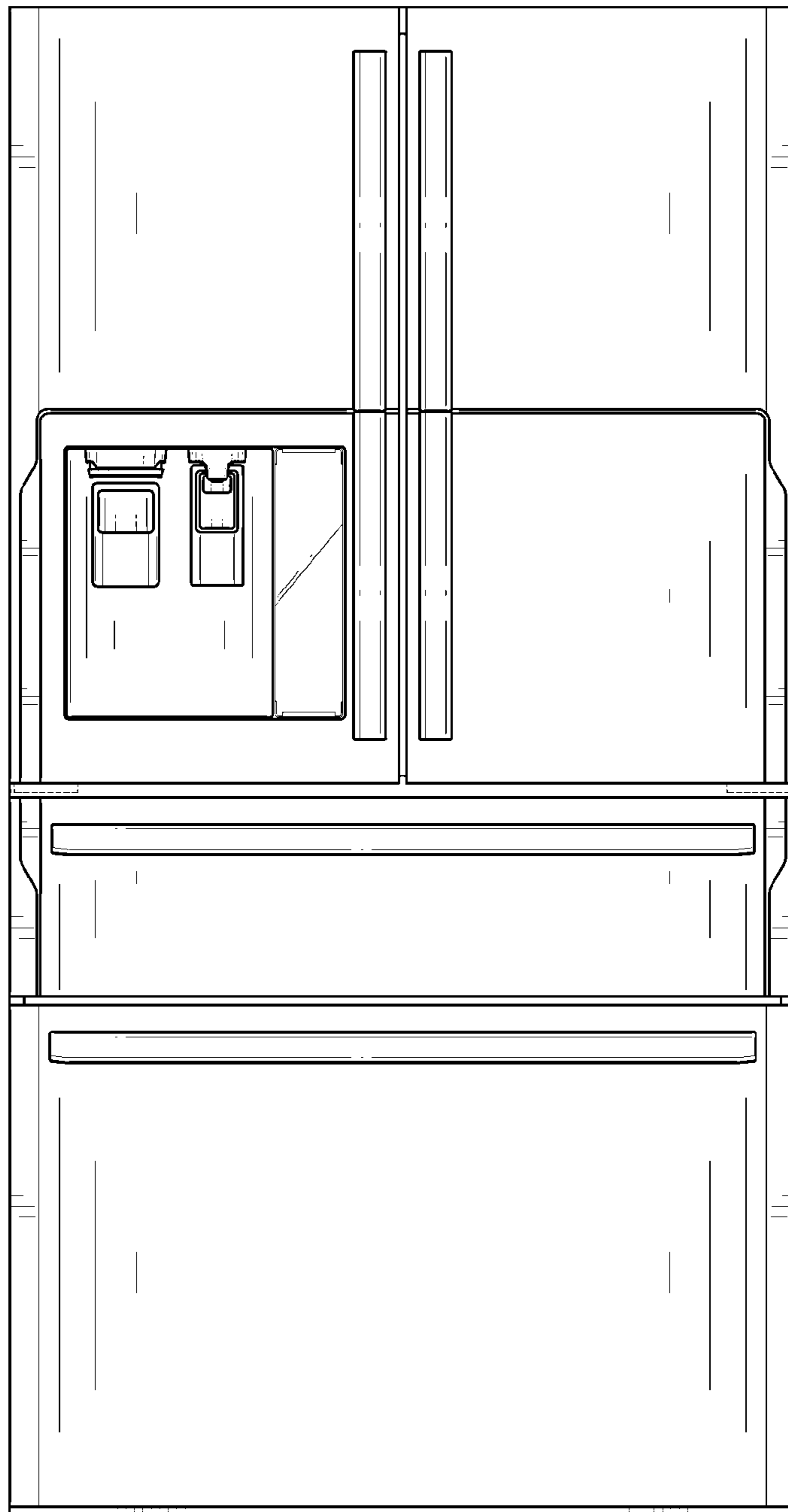

FIG. 3

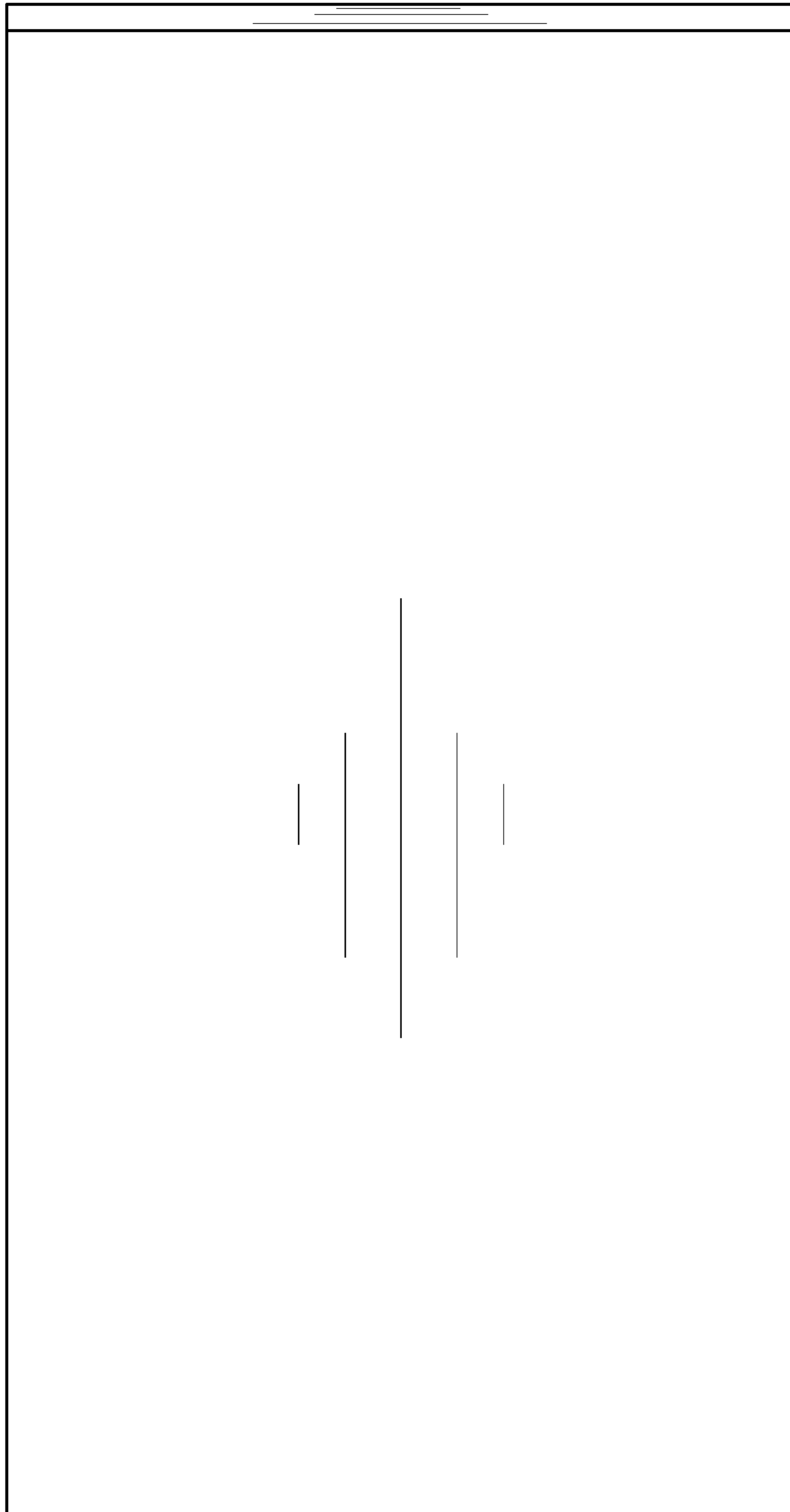

FIG. 4

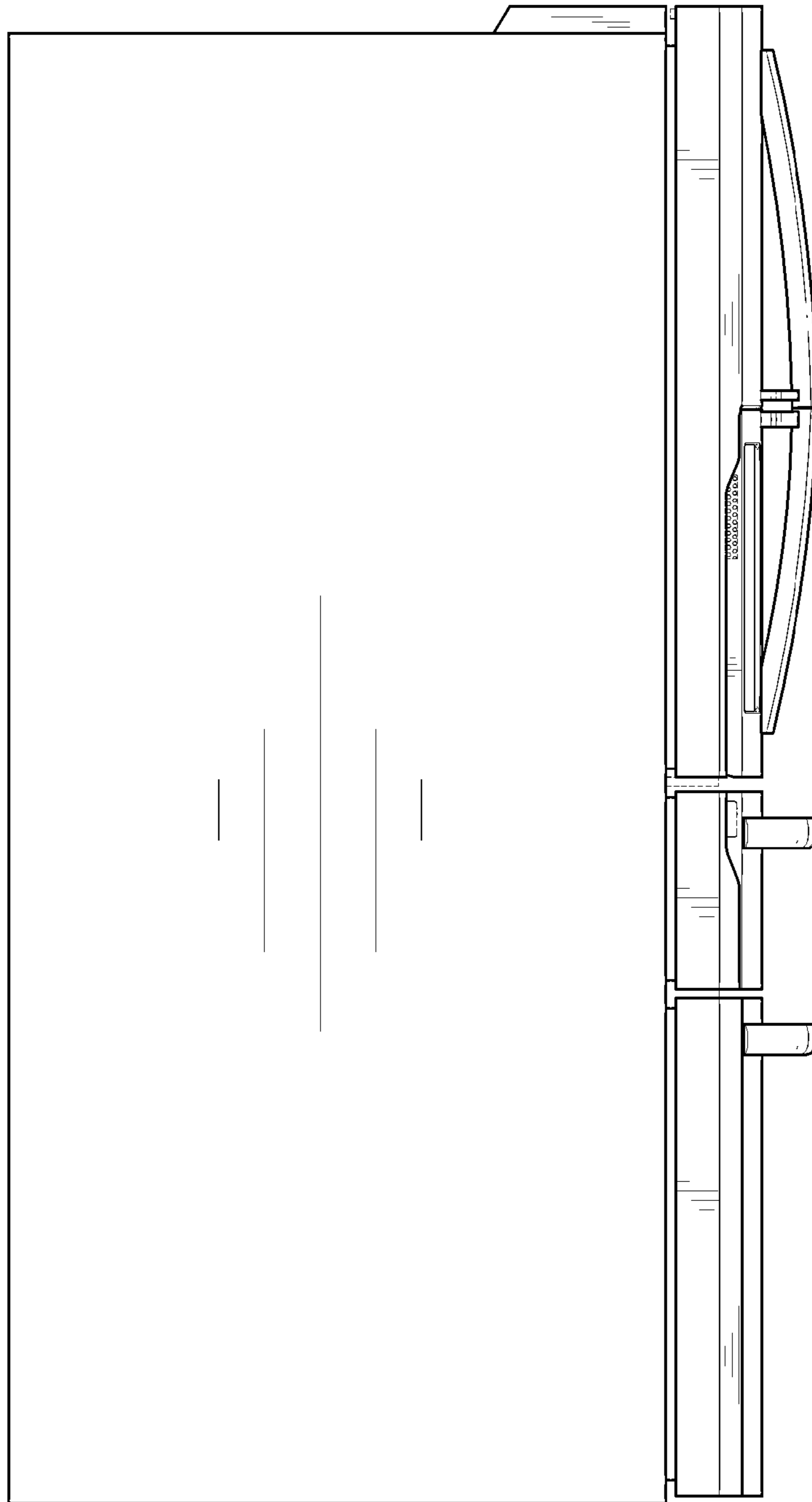

FIG. 5

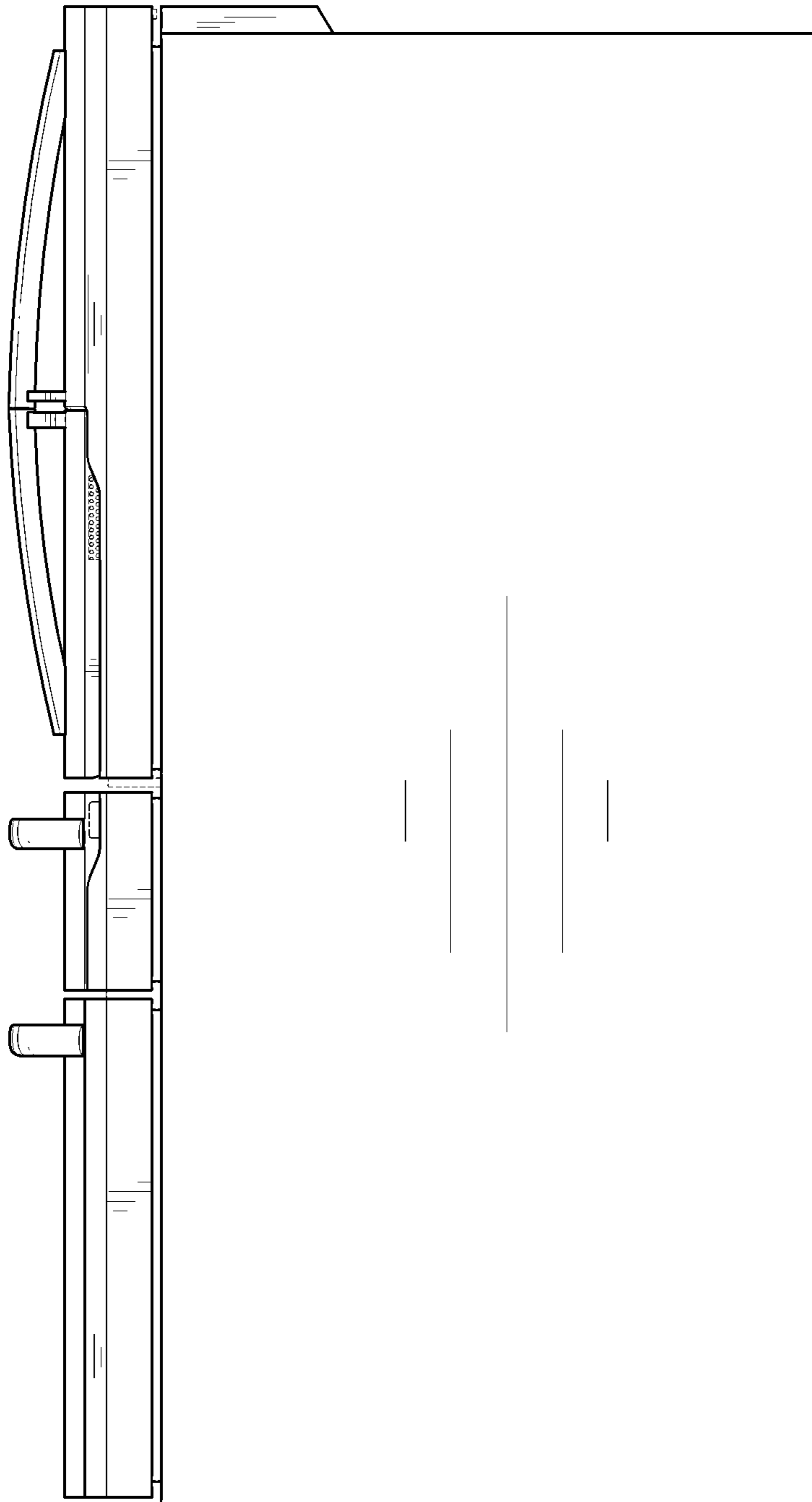

FIG. 6

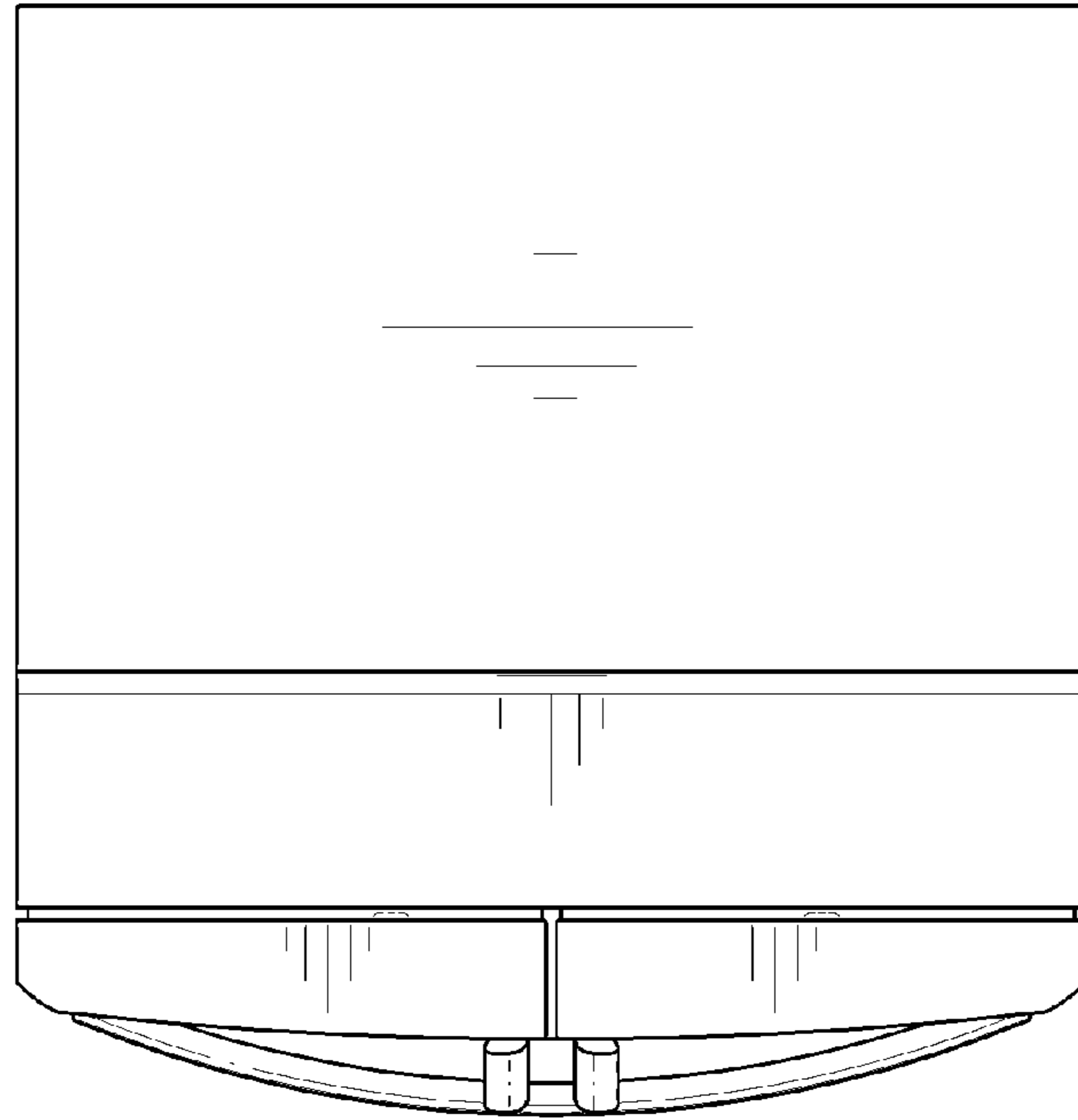

FIG. 7

