



US00D714762S

(12) **United States Design Patent**  
**O'Neil**

(10) **Patent No.:** **US D714,762 S**

(45) **Date of Patent:** **\*\* Oct. 7, 2014**

(54) **REMOTE CONTROLLER**

(71) Applicant: **Microsoft Corporation**, Redmond, WA  
(US)

(72) Inventor: **Dan O'Neil**, Sammamish, WA (US)

(73) Assignee: **Microsoft Corporation**, Redmond, WA  
(US)

(\*\*) Term: **14 Years**

(21) Appl. No.: **29/482,166**

(22) Filed: **Feb. 14, 2014**

(51) **LOC (10) Cl.** ..... **14-03**

(52) **U.S. Cl.**  
USPC ..... **D14/218**

(58) **Field of Classification Search**  
USPC ..... D14/218, 137-139, 174, 151, 191-193,  
D14/299, 167, 168; D13/168, 162-164;  
D21/512-517, 566; D10/104, 106;  
455/352-355, 151.1-151.4, 128, 347,  
455/90.3; 348/114, 734

See application file for complete search history.

(56) **References Cited**

**U.S. PATENT DOCUMENTS**

D476,975 S *	7/2003	Rodriquez, Sr.	.....	D14/218
D515,072 S *	2/2006	Lee	.....	D14/218
D532,777 S *	11/2006	Yu et al.	.....	D14/218
D546,807 S *	7/2007	Lee	.....	D14/138 AA
D559,202 S *	1/2008	Sim et al.	.....	D13/168
D568,827 S *	5/2008	Ikeda et al.	.....	D13/168
D614,605 S *	4/2010	Teh et al.	.....	D14/218
D622,703 S *	8/2010	Cheng Teh et al.	.....	D14/218

D628,986 S *	12/2010	VanDuyn et al.	.....	D14/218
D633,478 S *	3/2011	Bolton	.....	D14/218
D634,734 S *	3/2011	Cho	.....	D14/218
D638,825 S *	5/2011	VanDuyn et al.	.....	D14/218
D645,848 S *	9/2011	Arnholt et al.	.....	D14/218
D648,285 S *	11/2011	Kashimoto	.....	D13/168
D656,488 S *	3/2012	Nakayama et al.	.....	D14/218
D661,688 S *	6/2012	Weitgasser	.....	D14/218
D661,690 S *	6/2012	Weitgasser	.....	D14/218
D664,945 S *	8/2012	Morris et al.	.....	D14/218
D664,946 S *	8/2012	Morris et al.	.....	D14/218
D669,452 S *	10/2012	Akana et al.	.....	D14/218
D687,815 S *	8/2013	Hwangho et al.	.....	D14/218
D695,272 S *	12/2013	Hansen et al.	.....	D14/218
D697,497 S *	1/2014	Lai	.....	D14/218

\* cited by examiner

*Primary Examiner* — John Windmuller

(74) *Attorney, Agent, or Firm* — Banner & Witcoff, Ltd.

(57) **CLAIM**

The ornamental design for a remote controller, as shown and described.

**DESCRIPTION**

FIG. 1 is a front perspective view of a remote controller showing my new design;  
FIG. 2 is a front view thereof;  
FIG. 3 is a rear view thereof;  
FIG. 4 is a right side view thereof;  
FIG. 5 is a left side view thereof;  
FIG. 6 is a top view thereof; and,  
FIG. 7 is a bottom view thereof.

The broken lines in the figures depict portions of the remote controller that form no part of the claimed design.

**1 Claim, 5 Drawing Sheets**

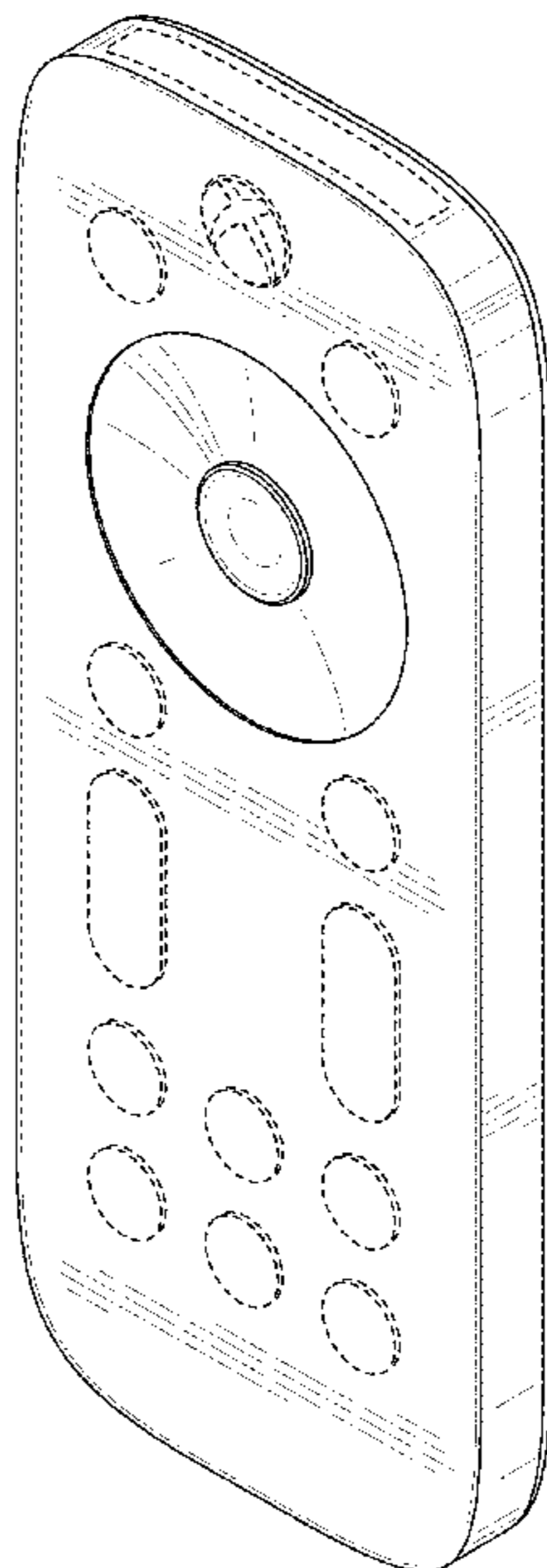

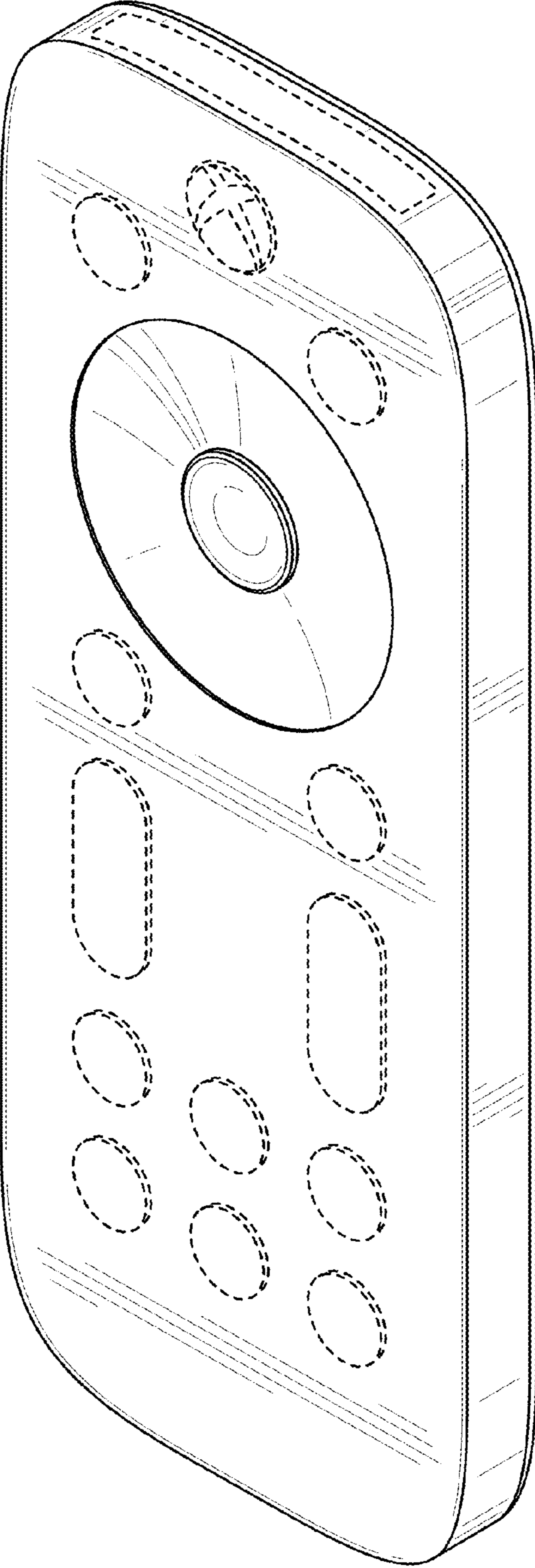

FIG. 1

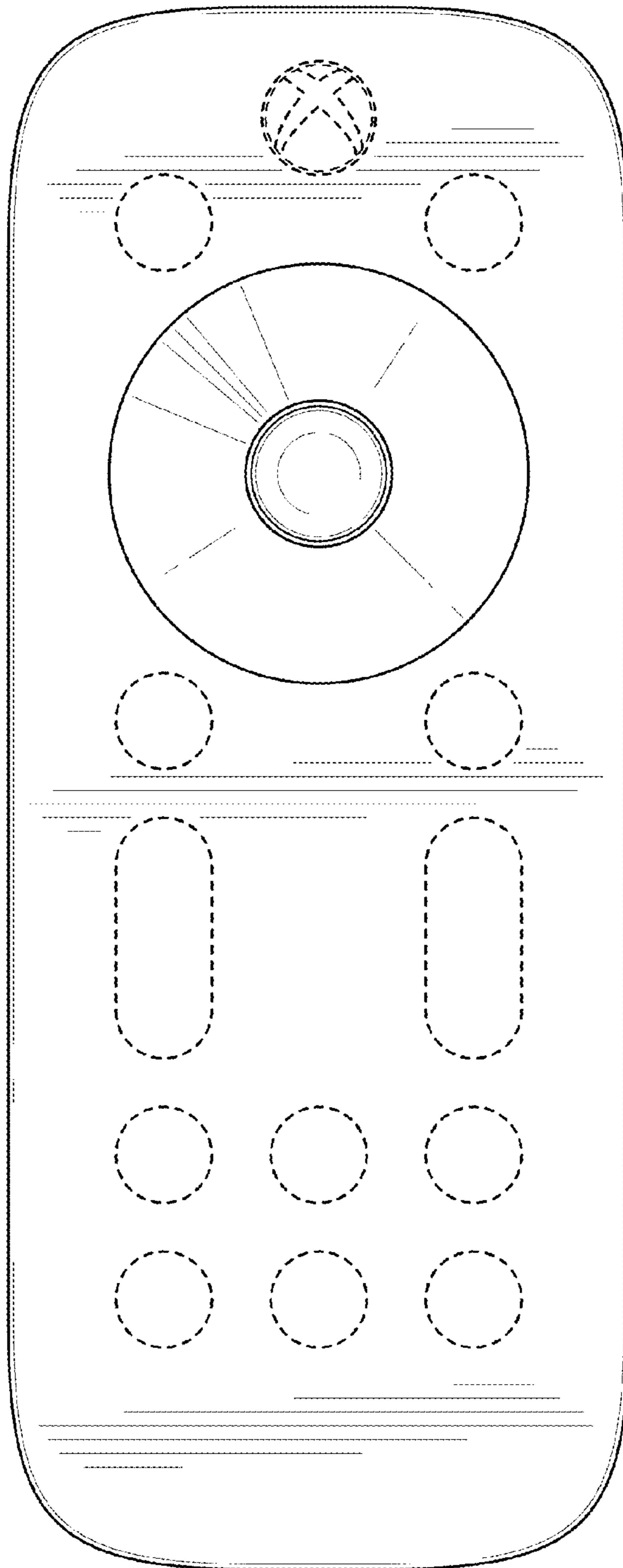

FIG. 2

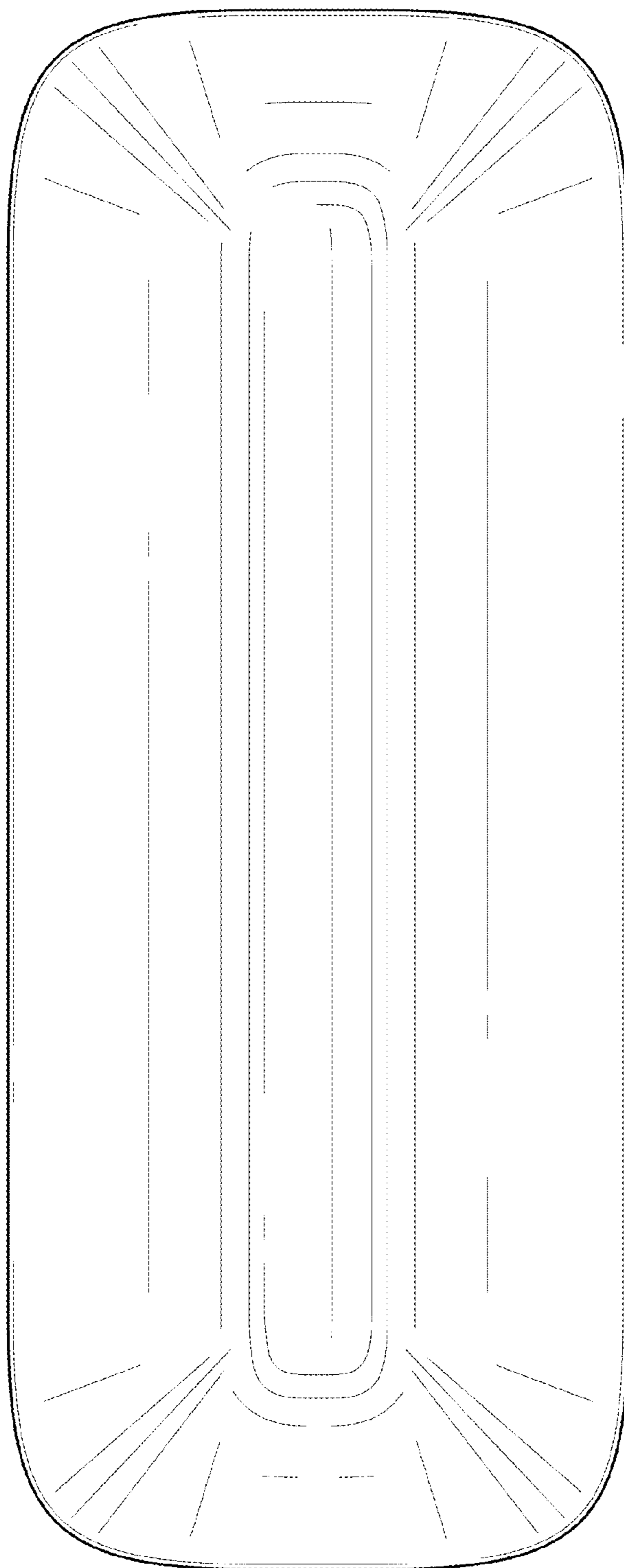

FIG. 3

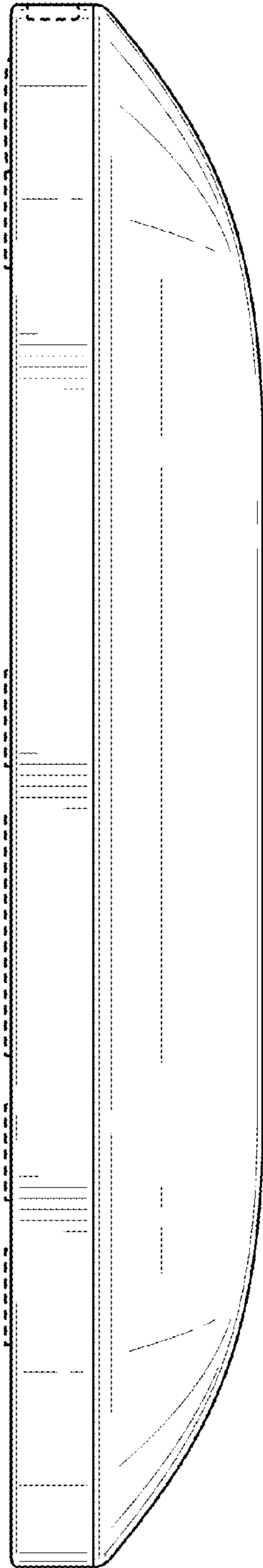

FIG. 4

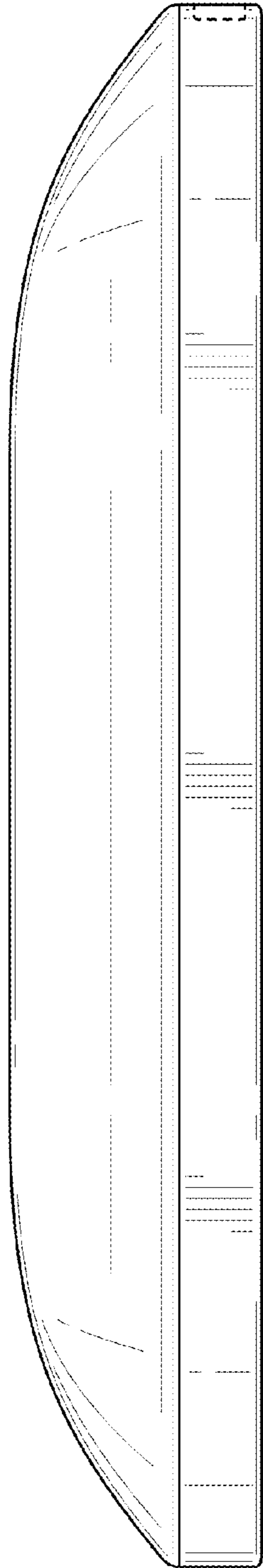

FIG. 5

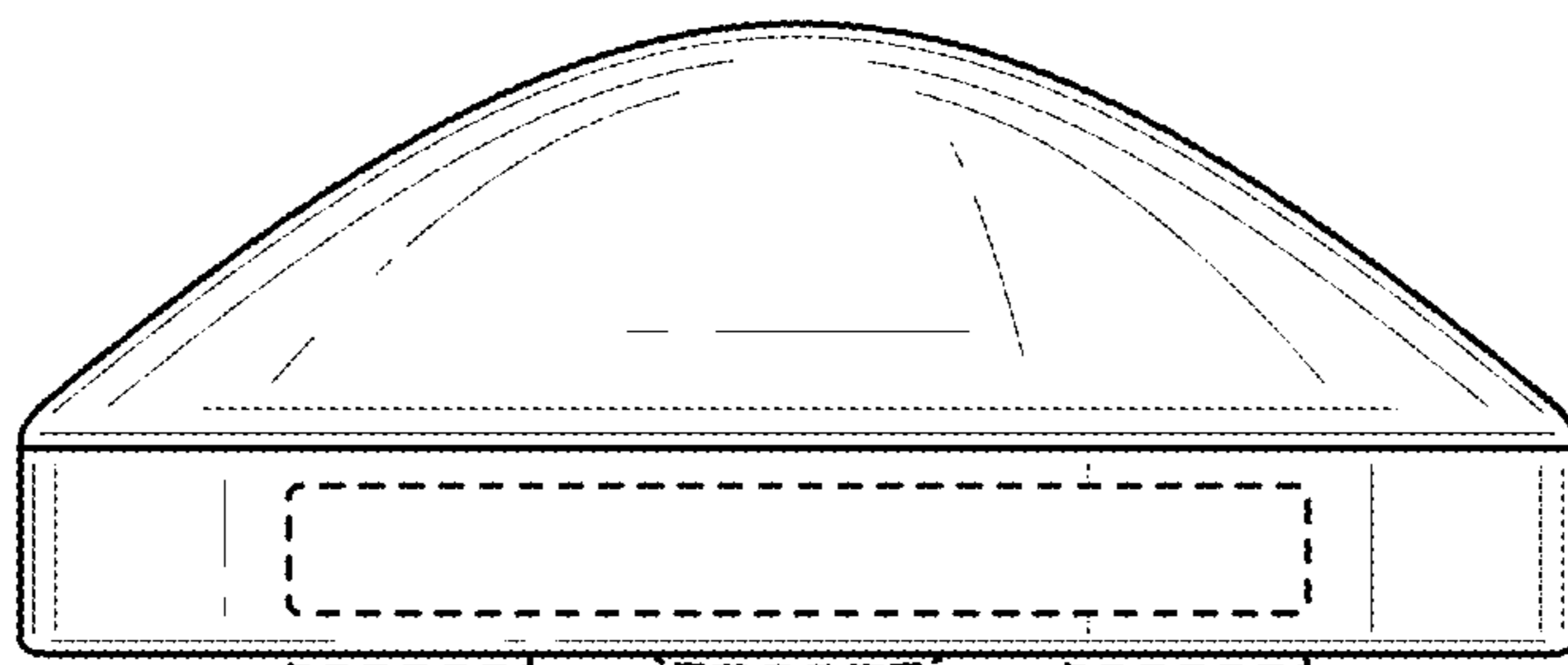

FIG. 6

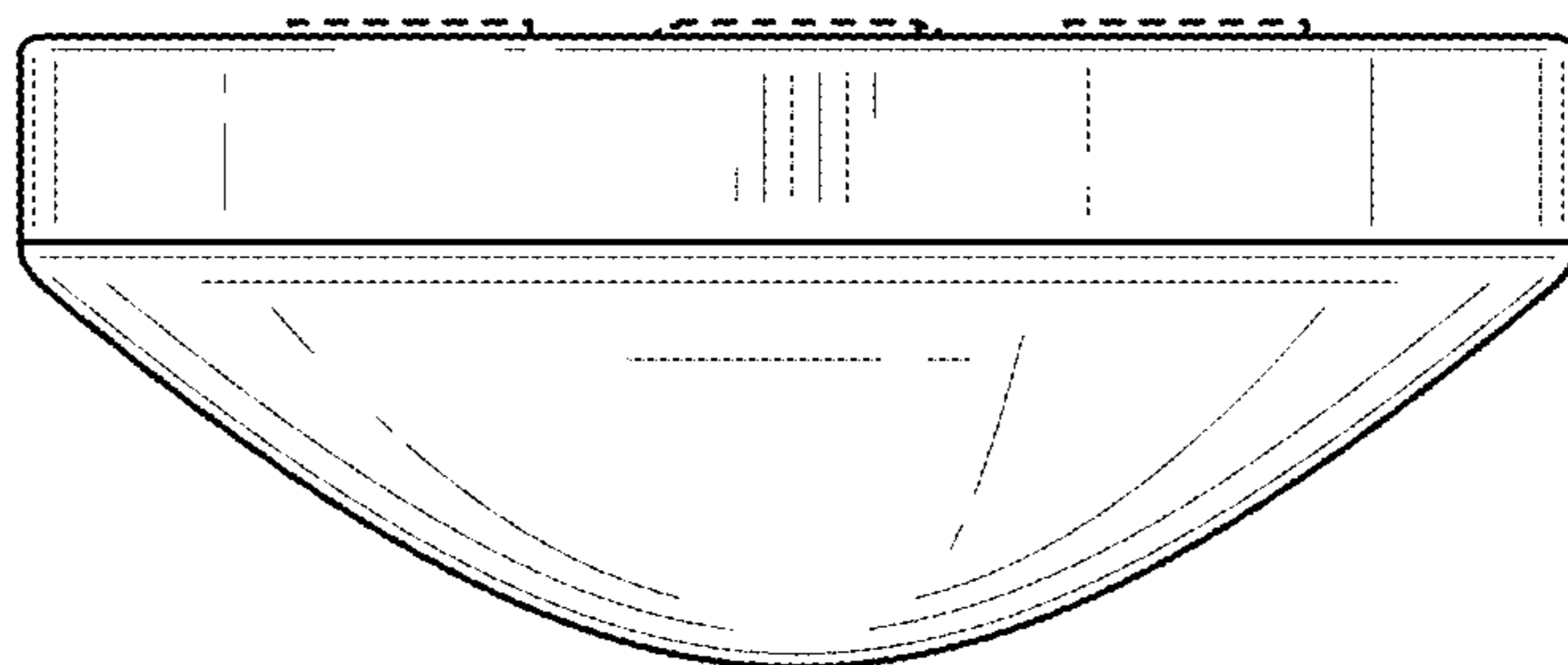

FIG. 7