



US00D714757S

(12) **United States Design Patent**
Lee et al.

(10) **Patent No.:** **US D714,757 S**
(45) **Date of Patent:** **** Oct. 7, 2014**

(54) **STAND WITH SPEAKER FOR TELEVISION RECEIVER**

(71) Applicant: **LG Electronics Inc.**, Seoul (KR)

(72) Inventors: **Yongho Lee**, Seoul (KR); **Hyojin Won**, Seoul (KR)

(73) Assignee: **LG Electronics Inc.**, Seoul (KR)

(**) Term: **14 Years**

(21) Appl. No.: **29/460,828**

(22) Filed: **Jul. 16, 2013**

(30) **Foreign Application Priority Data**

Jan. 16, 2013 (KR) 30-2013-0002745

(51) **LOC (10) Cl.** **14-01**

(52) **U.S. Cl.**
USPC **D14/209.1**

(58) **Field of Classification Search**
CPC H05K 5/00; H04R 1/00; H04R 15/06;
H04R 27/00; H04R 2227/06; H04R 2400/00
USPC D14/204, 218, 172, 210-216, 209.1;
181/143, 147, 148, 150, 153, 157, 198,
181/199, 166, 144; 381/300-303, 306, 332,
381/333, 336, 345, 361-364, 370, 386-388,
381/145, 182

See application file for complete search history.

(56) **References Cited**

U.S. PATENT DOCUMENTS

4,553,628 A * 11/1985 Nakamura 181/145
4,940,108 A * 7/1990 Selby 181/145

| | | | | |
|----------------|--------|---------------|-------|-----------|
| D328,898 S * | 8/1992 | Christie | | D14/211 |
| 5,802,190 A * | 9/1998 | Ferren | | 381/182 |
| D471,891 S * | 3/2003 | Oikawa | | D14/211 |
| 7,319,767 B2 * | 1/2008 | Fidlin et al. | | 381/182 |
| D562,307 S * | 2/2008 | Warden | | D14/211 |
| D610,576 S * | 2/2010 | Oliver | | D14/230 |
| D656,485 S * | 3/2012 | Lee et al. | | D14/211 |
| D681,007 S * | 4/2013 | Ryu et al. | | D14/213 |
| D683,330 S * | 5/2013 | Ryu et al. | | D14/209.1 |
| D687,812 S * | 8/2013 | Lee | | D14/211 |

* cited by examiner

Primary Examiner — Prabhakar Deshmukh

(74) *Attorney, Agent, or Firm* — Morgan, Lewis & Bockius LLP

(57) **CLAIM**

The ornamental design for a stand with speaker for television receiver, as shown and described.

DESCRIPTION

FIG. 1 is a perspective view of a stand with speaker for television receiver showing our new design;
FIG. 2 is a front view thereof where the rear view is a mirror image;
FIG. 3 is a left side view thereof;
FIG. 4 is a right side view thereof;
FIG. 5 is a top plan view thereof;
FIG. 6 is a bottom plan view thereof; and,
FIG. 7 is a rear perspective view thereof showing the state that the stand with speaker for television receiver is combined with each side of the television.
The broken lines are for illustrative purposes only and form no part of the claimed design.

1 Claim, 7 Drawing Sheets

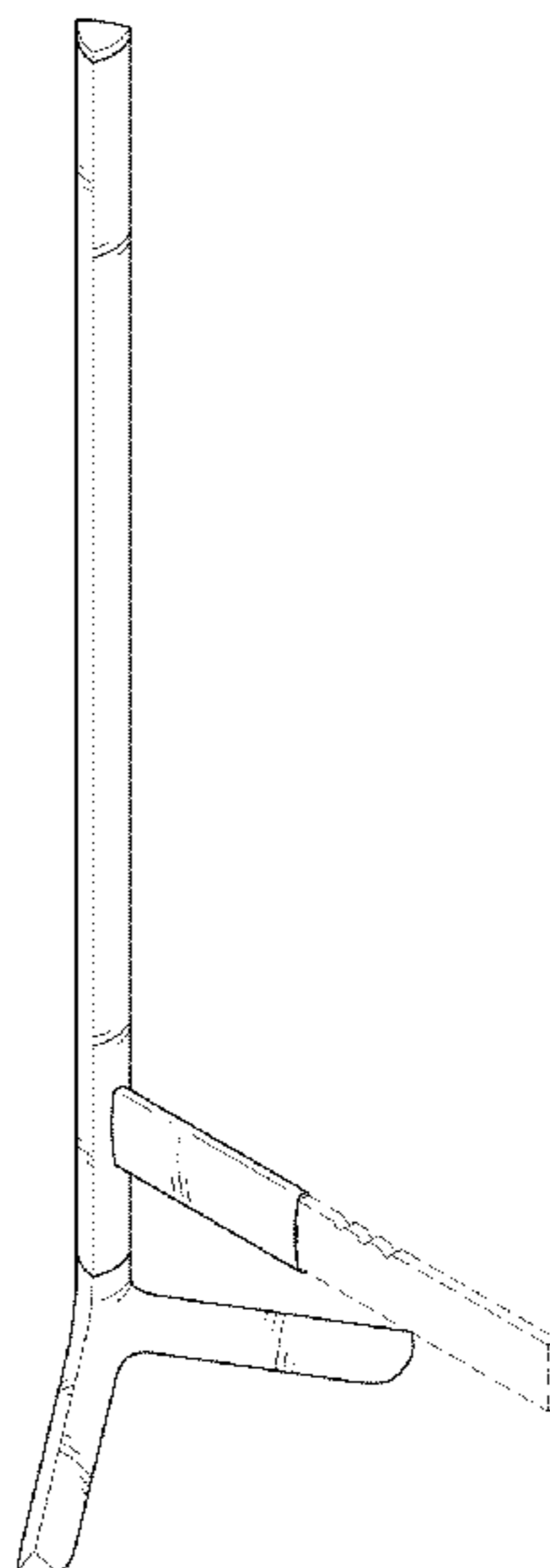

FIG. 1

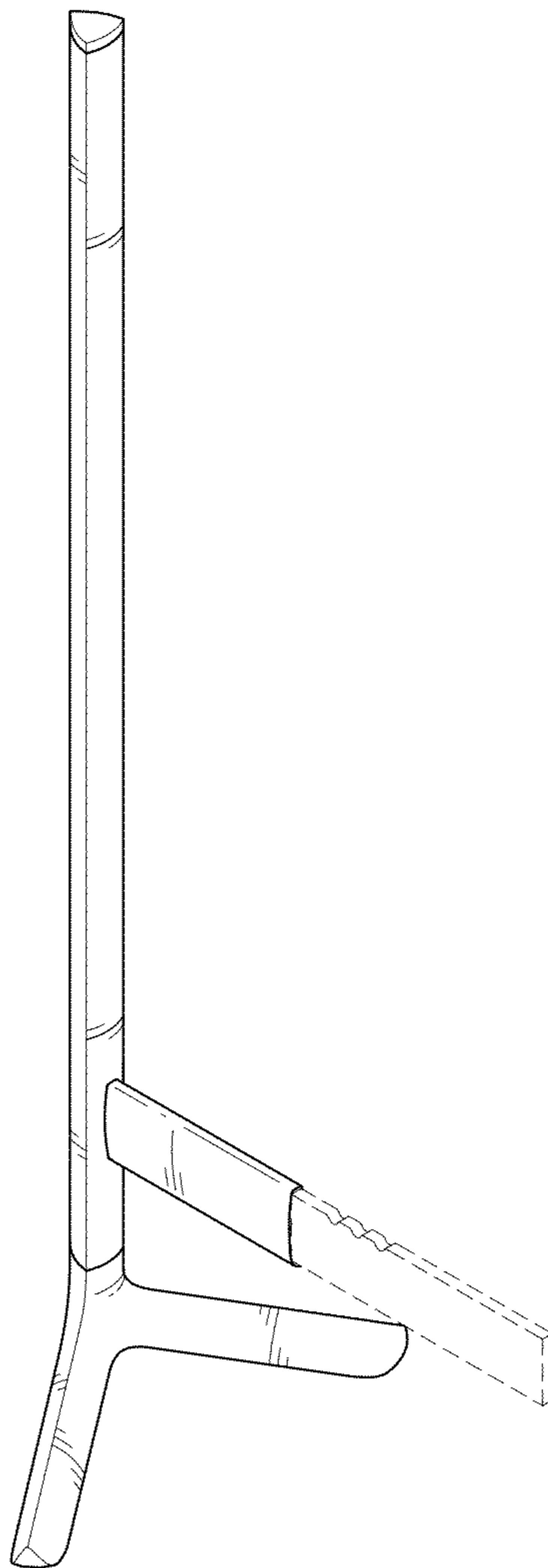

FIG. 2

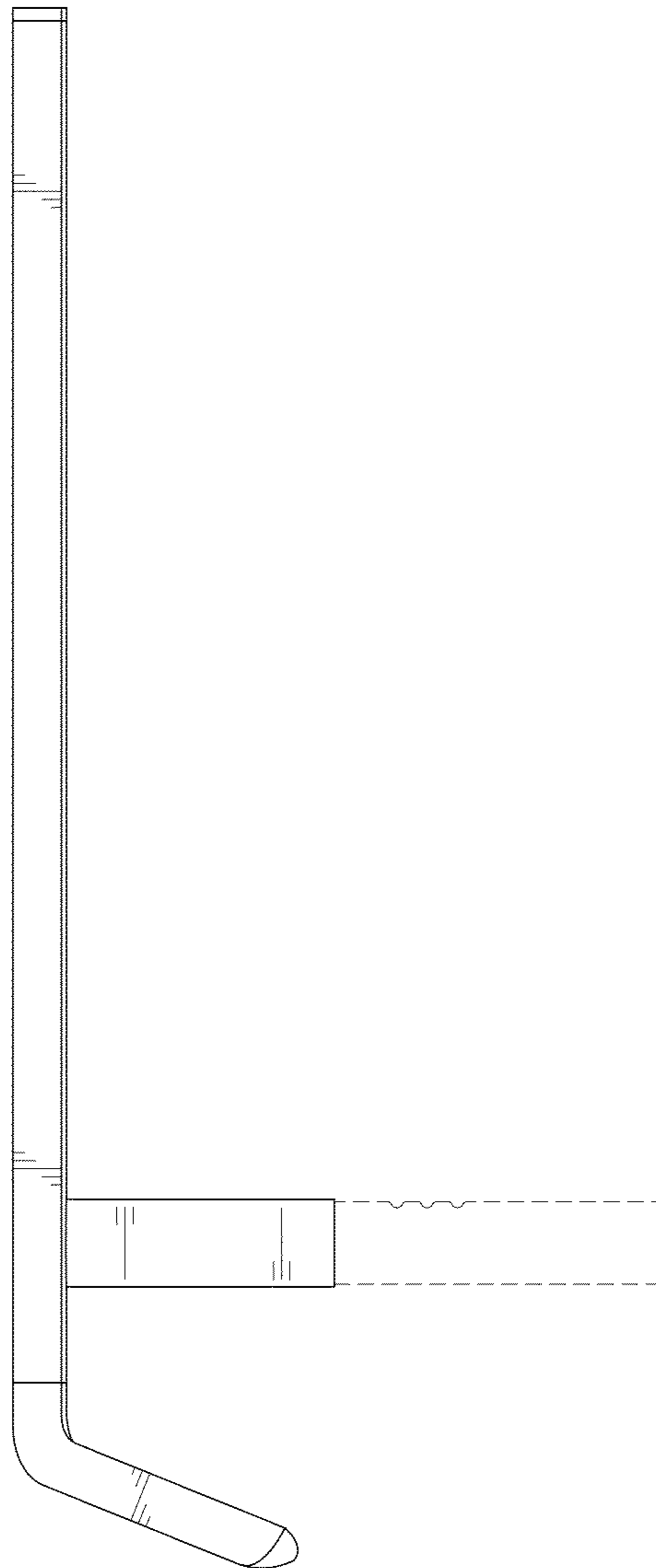

FIG. 3

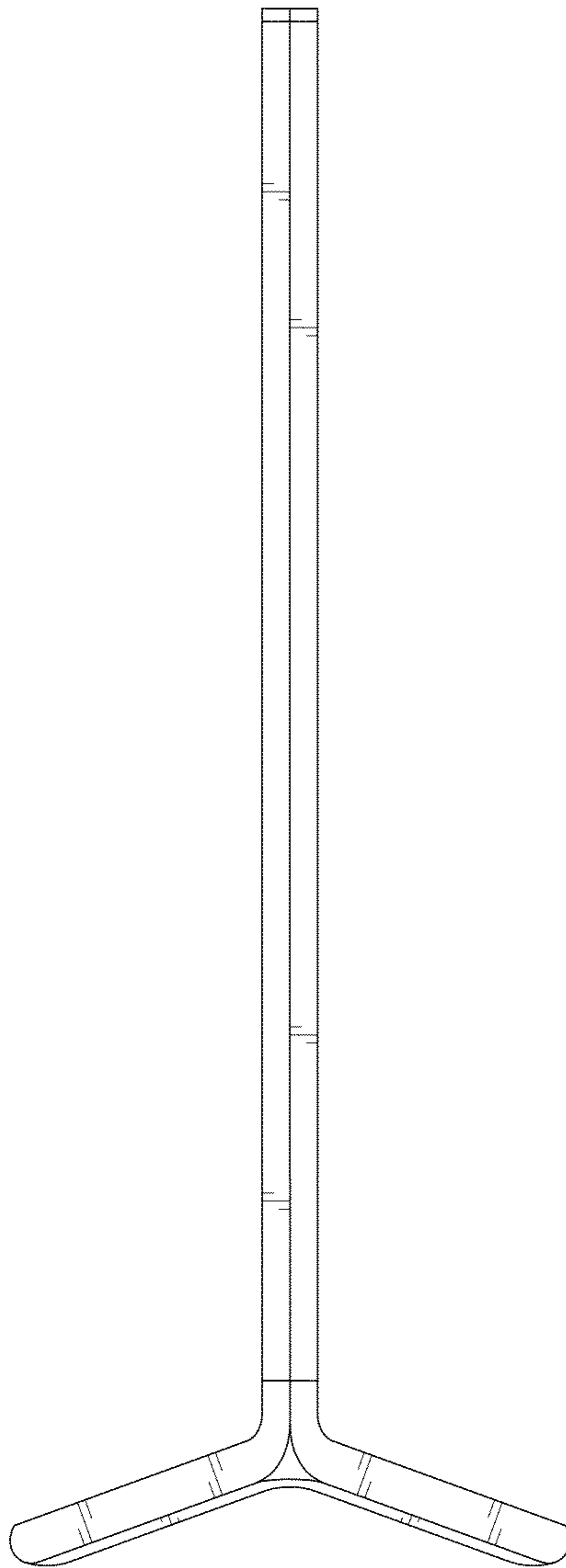

FIG. 4

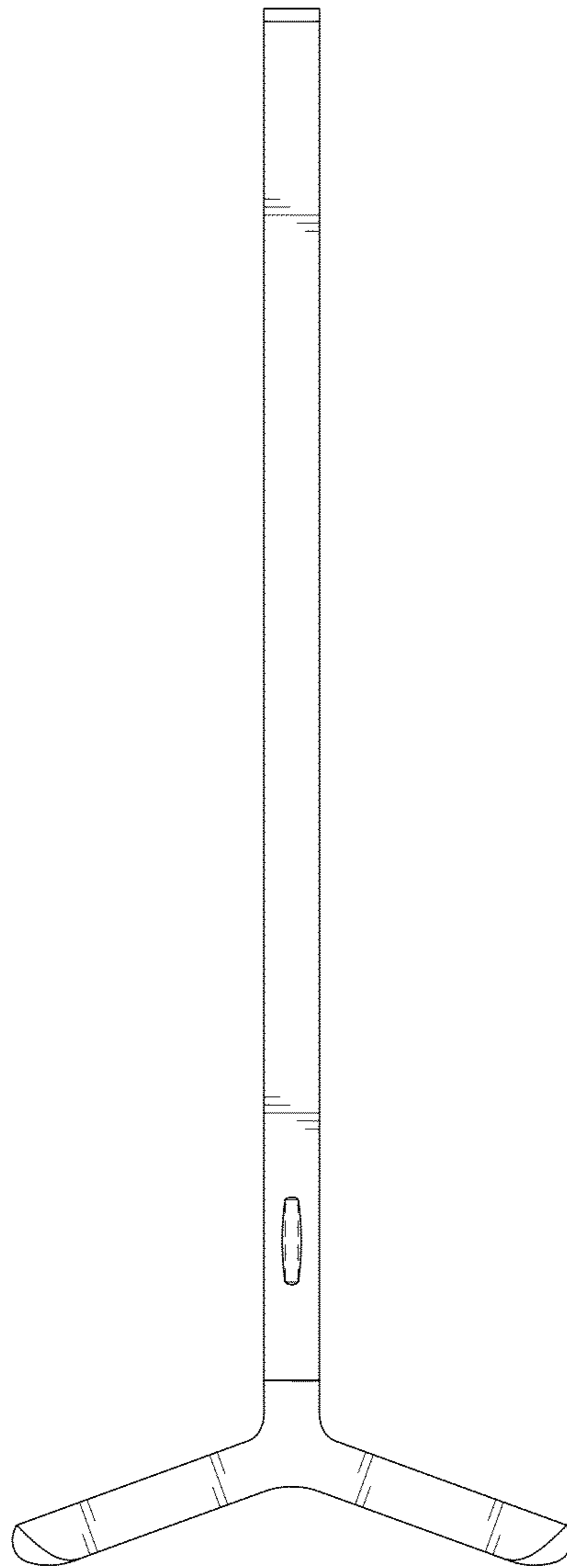

FIG. 5

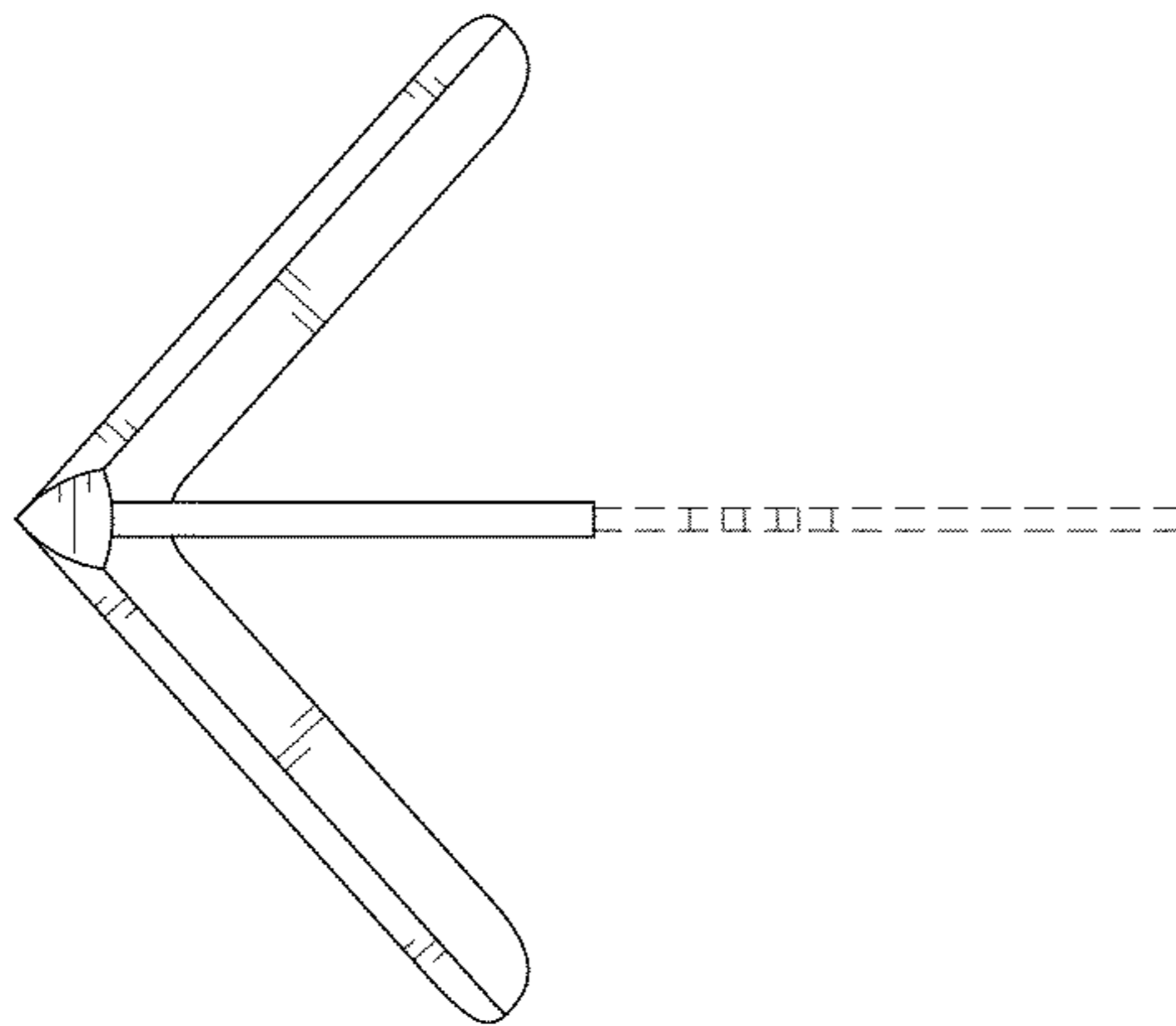

FIG. 6

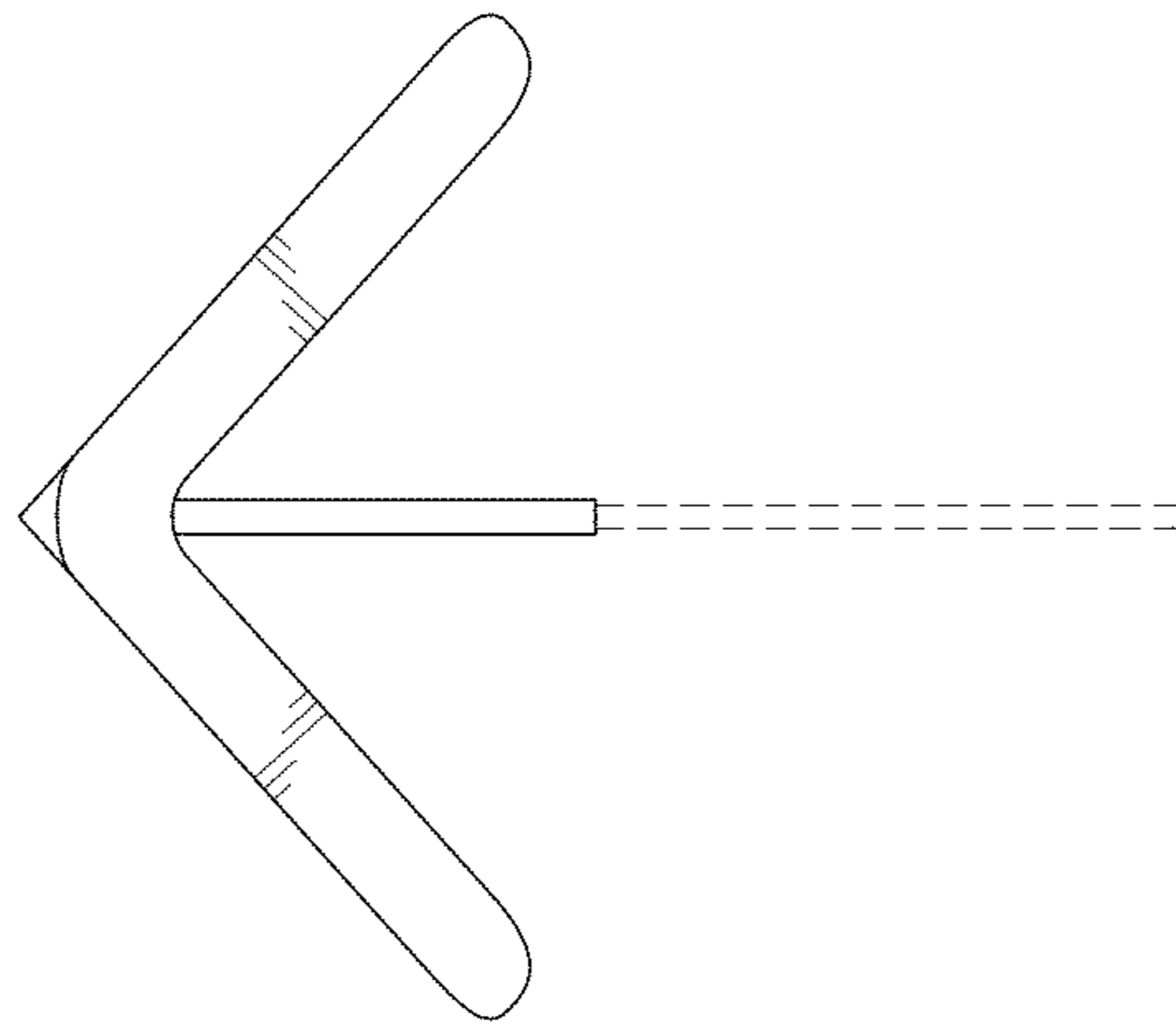

FIG. 7

