



US00D714754S

(12) **United States Design Patent**
Moriyama

(10) **Patent No.:** **US D714,754 S**

(45) **Date of Patent:** **** Oct. 7, 2014**

(54) **TELEPHONE BASE UNIT**
(71) Applicant: **Panasonic Corporation**, Osaka (JP)
(72) Inventor: **Toshiya Moriyama**, Fukuoka (JP)
(73) Assignee: **Panasonic Corporation**, Osaka (JP)

D596,611 S * 7/2009 Hasegawa et al. D14/149
D599,771 S * 9/2009 Nakajima D14/149
D603,365 S * 11/2009 Nakajima D14/149
D617,303 S * 6/2010 Hasegawa et al. D14/149
D624,898 S 10/2010 Hasegawa et al.
D657,771 S * 4/2012 Sakamoto D14/150

* cited by examiner

(**) Term: **14 Years**

Primary Examiner — Caron D Veynar

Assistant Examiner — Holly E Thurman

(21) Appl. No.: **29/435,292**

(74) *Attorney, Agent, or Firm* — Panasonic Patent Center

(22) Filed: **Oct. 23, 2012**

(51) **LOC (10) Cl.** **14-01**

(57) **CLAIM**

(52) **U.S. Cl.**
USPC **D14/149**

I claim the ornamental design for a telephone base unit, as shown and described.

(58) **Field of Classification Search**
USPC D14/47, 148, 149, 138 R, 138 AA,
D14/138 AD, 138 G, 203.1–203.8, 496, 137,
D14/218, 341–347, 247–248, 144, 150–151,
D14/240, 243; 455/566, 575.1, 575.3,
455/575.4; 348/168, 169, 167

DESCRIPTION

See application file for complete search history.

FIG. 1 is a perspective view of a telephone base unit showing my new design;
FIG. 2 is a front view thereof;
FIG. 3 is a first side view thereof;
FIG. 4 is a second side view thereof;
FIG. 5 is a top view thereof;
FIG. 6 is a rear view thereof; and,
FIG. 7 is a bottom view thereof.

The broken lines depict unclaimed portions of the telephone base unit, which form no part of the claimed design.

(56) **References Cited**

U.S. PATENT DOCUMENTS

D562,797 S * 2/2008 Beasley et al. D14/149
D570,324 S * 6/2008 Furuno et al. D14/149
D570,325 S * 6/2008 Hasegawa et al. D14/149
D576,997 S * 9/2008 Furuno et al. D14/149
D582,383 S * 12/2008 Hasegawa et al. D14/149

1 Claim, 7 Drawing Sheets

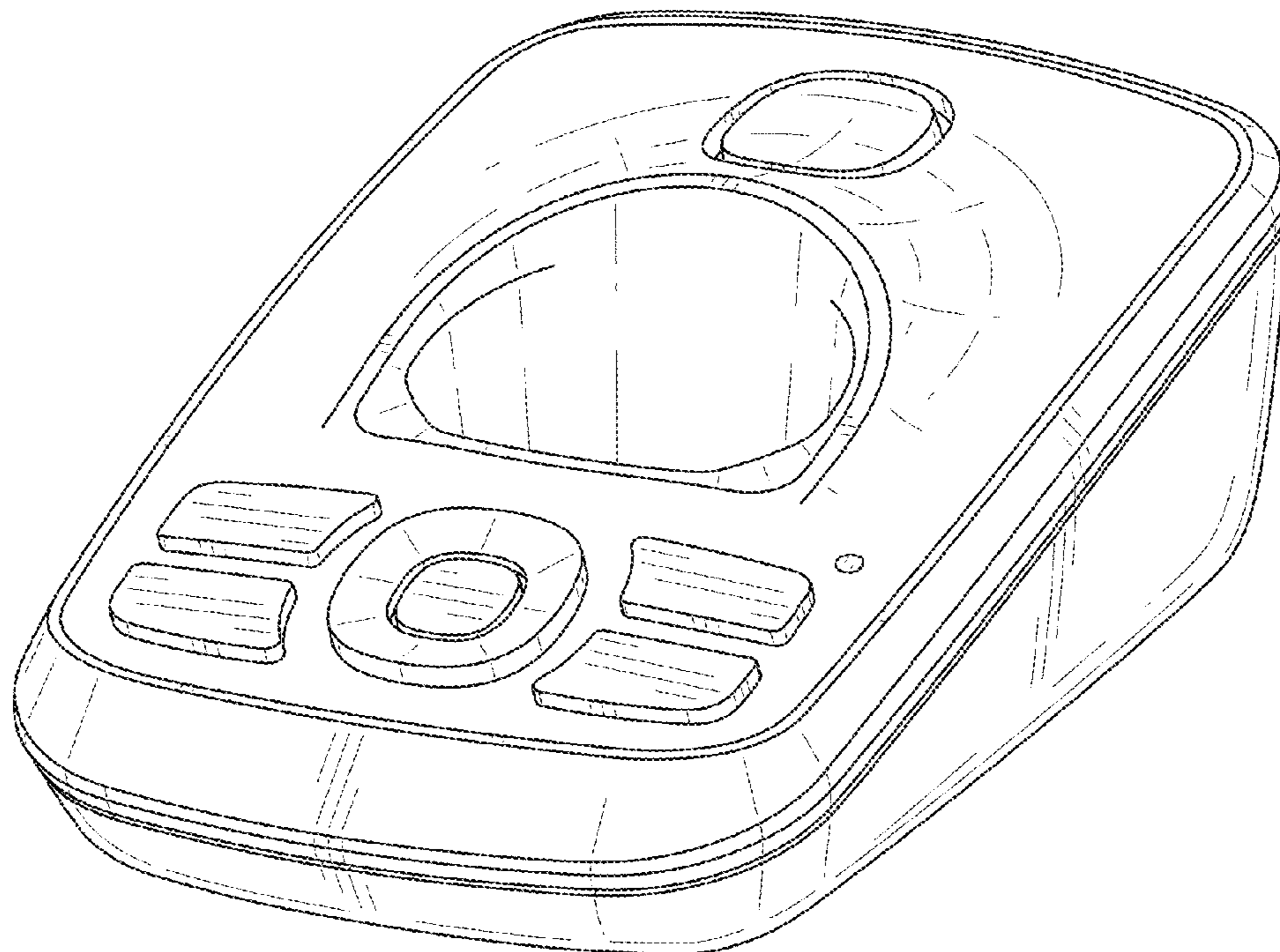

FIG. 1

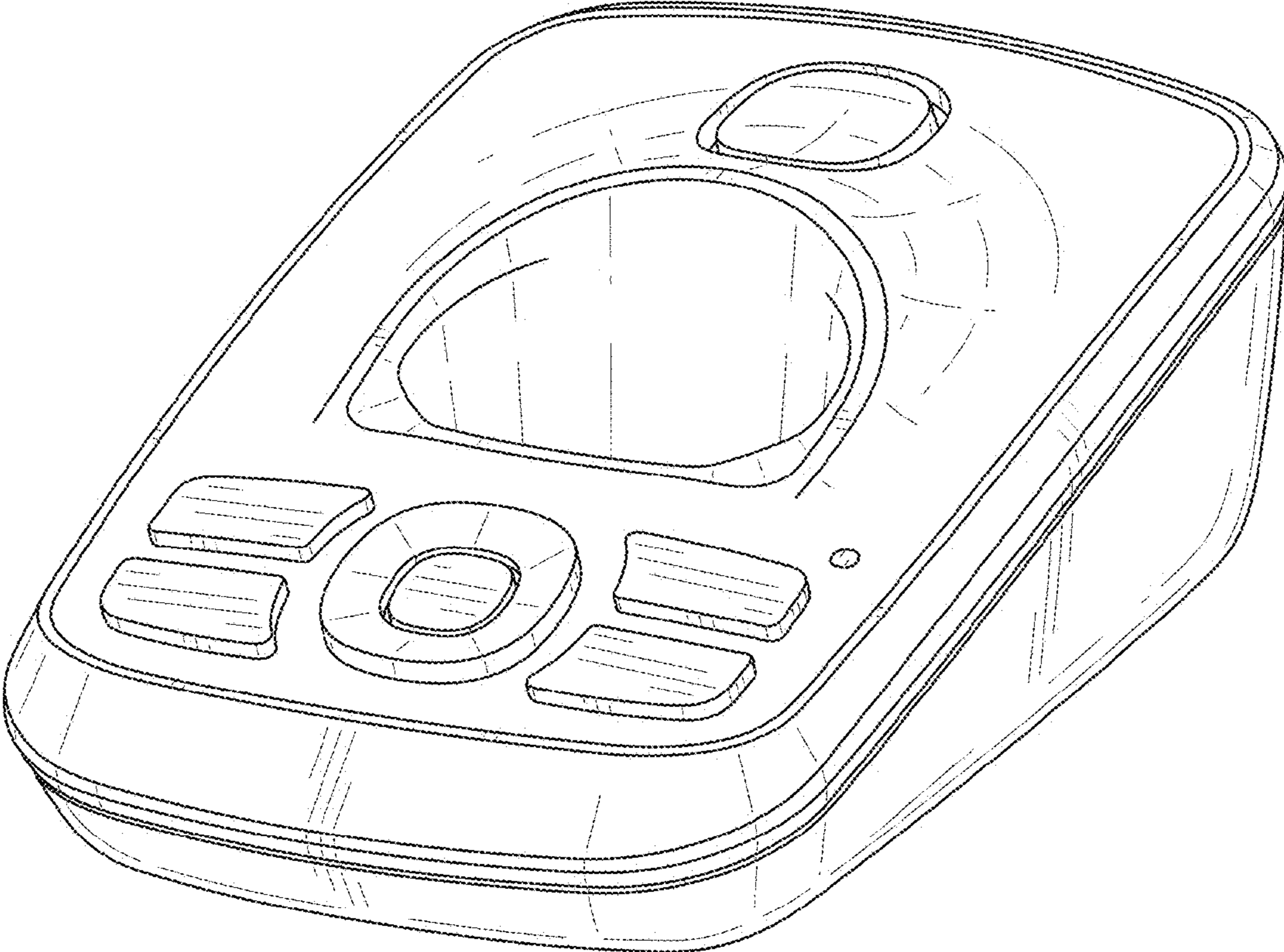

FIG. 2

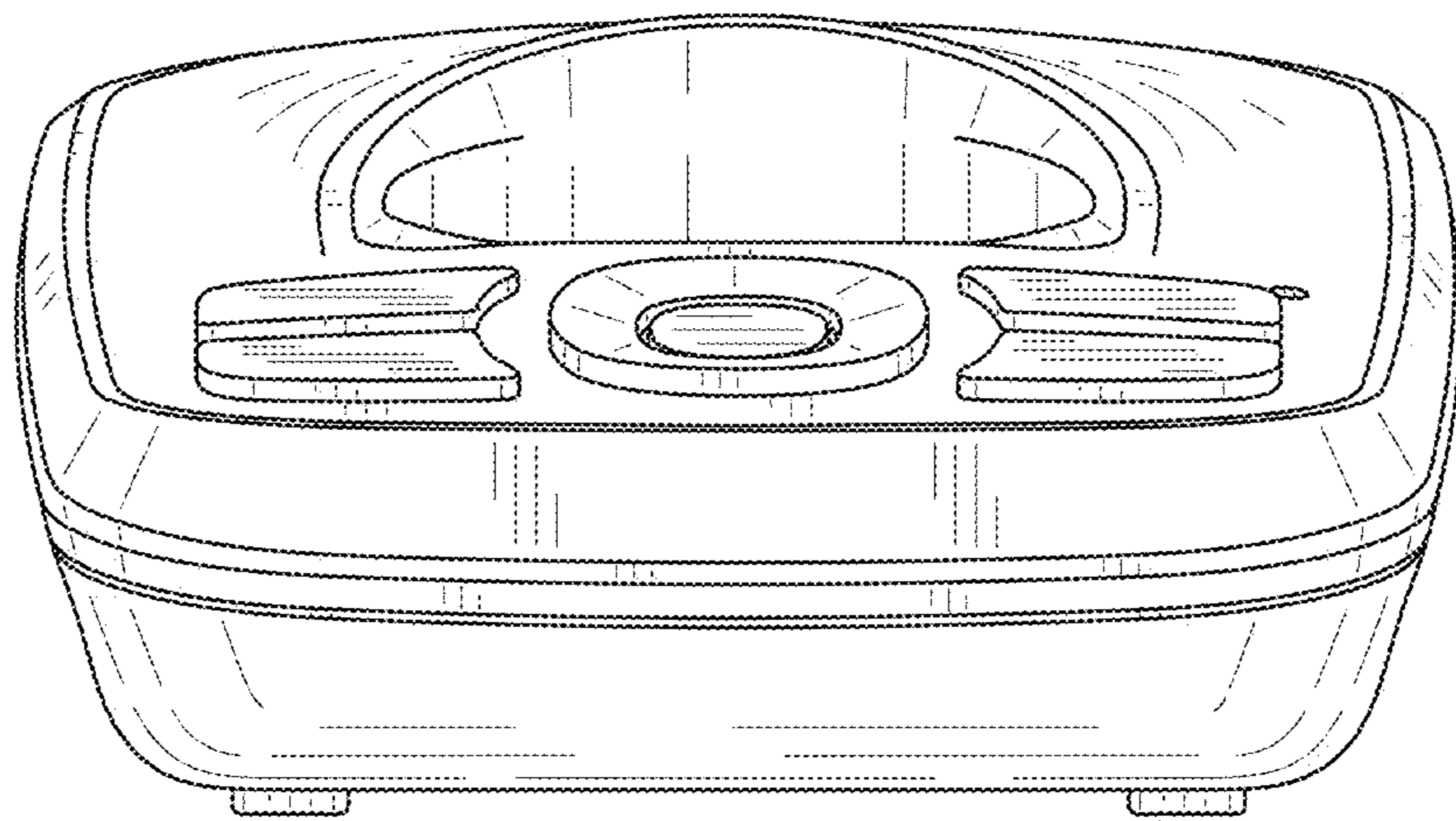

FIG. 3

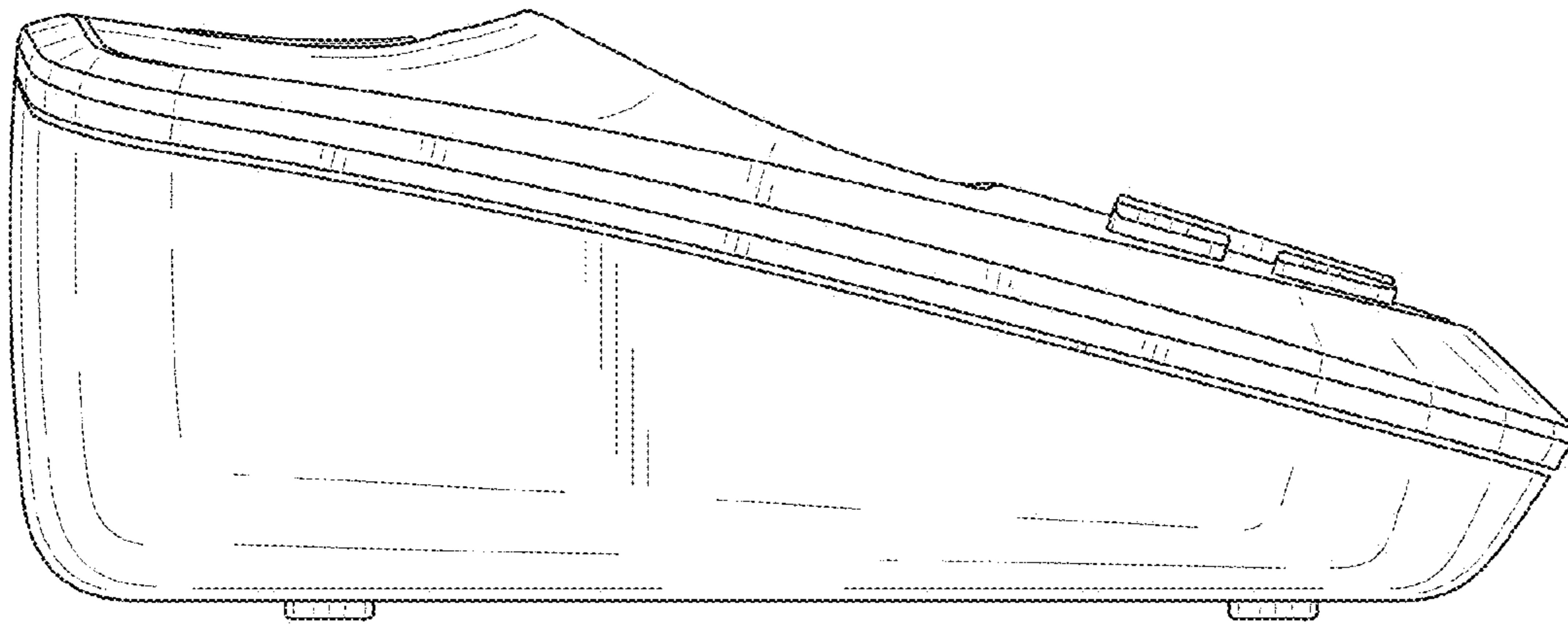

FIG. 4

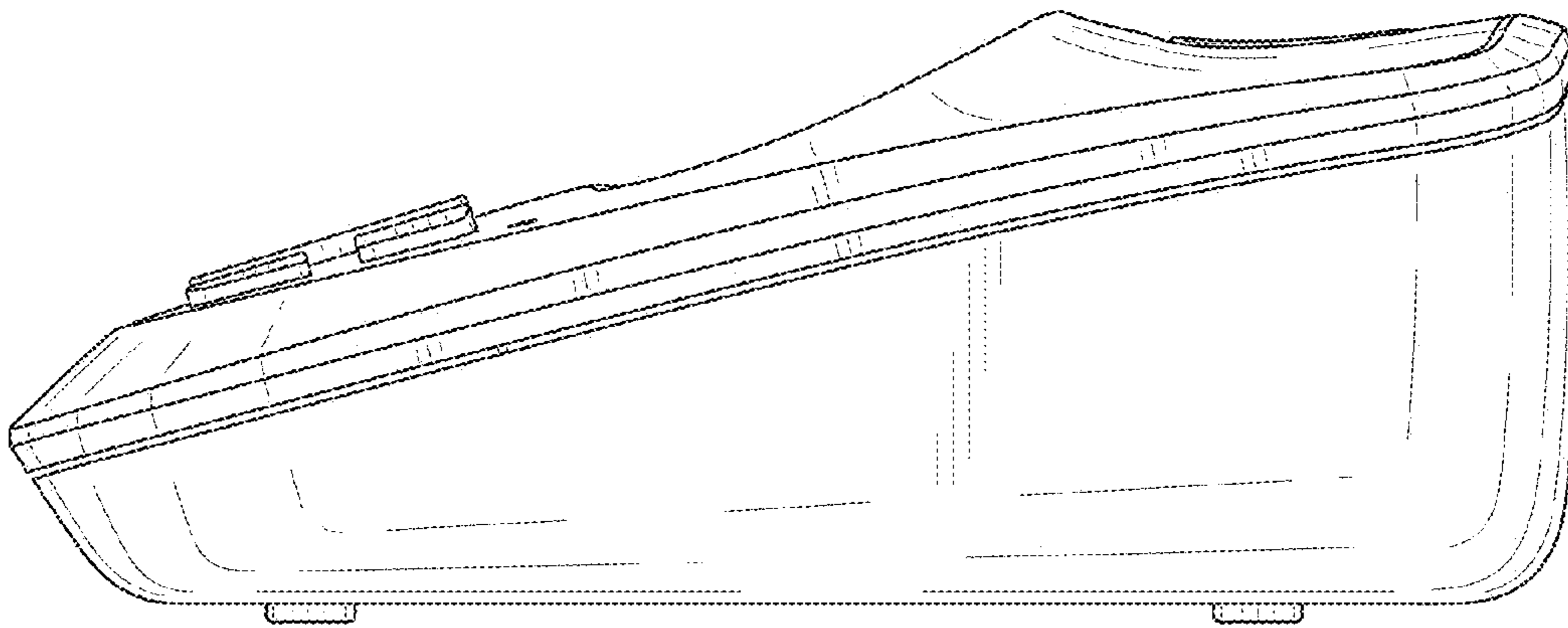

FIG. 5

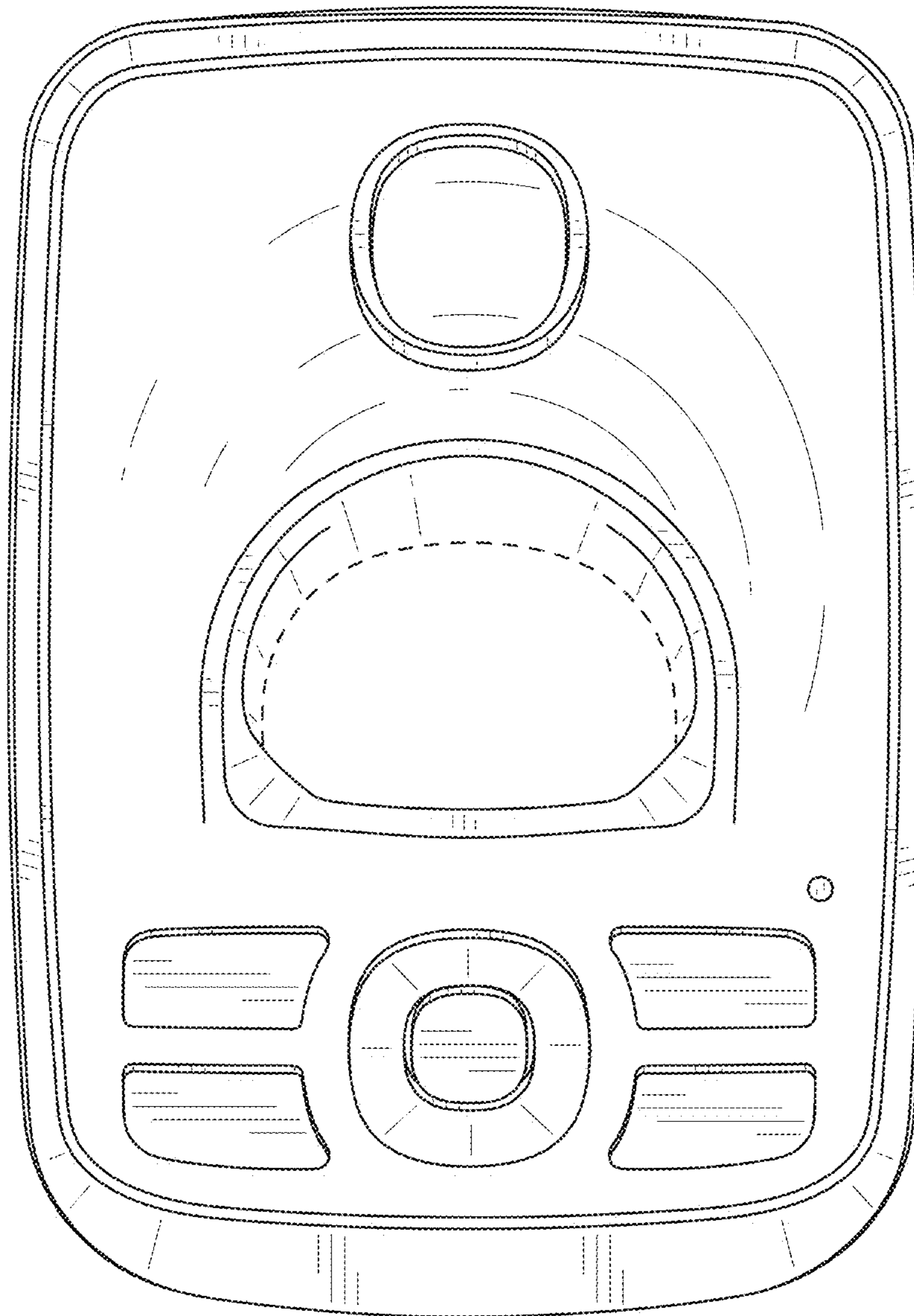

FIG. 6

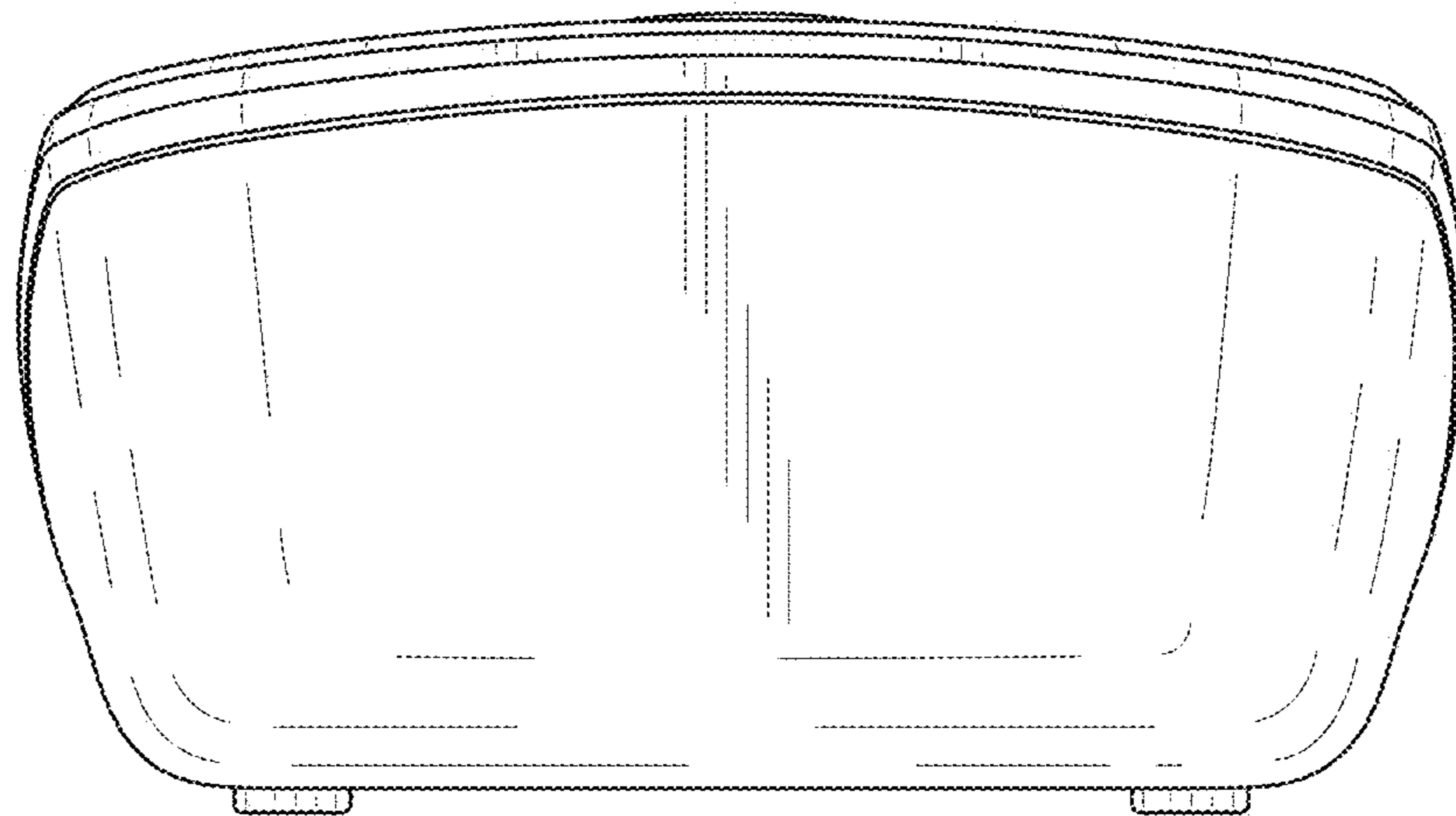

FIG. 7

