



US00D714746S

(12) **United States Design Patent**
Euiseok et al.

(10) **Patent No.:** **US D714,746 S**
(45) **Date of Patent:** **** Oct. 7, 2014**

(54) **TV RECEIVER**

(75) Inventors: **Kim Euiseok**, Sungnam-si (KR); **Hee Bong Kim**, Seoul (KR)

(73) Assignee: **Samsung Electronics Co., Ltd.**, Gyeonggi-do (KR)

(**) Term: **14 Years**

(21) Appl. No.: **29/422,139**

(22) Filed: **May 17, 2012**

(51) **LOC (10) Cl.** **14-03**

(52) **U.S. Cl.**
USPC **D14/126**

(58) **Field of Classification Search**

CPC H04N 21/42224; H04N 2005/443; H04N 21/4122; H04N 21/41407; H04N 21/4222; H04N 21/43615; H04N 21/43635; H04N 5/4403; H04N 5/64; H04N 5/655; H04N 5/645; H04N 7/00

USPC D14/126, 127, 128, 129, 239, 371, 136, D14/341; 312/7.2; 348/836, 838, 180, 184, 348/325, 739; 341/12; 248/917-924, 465; 345/104, 133, 156, 168, 87, 173; 720/605, 600, 655; 455/347; 273/148 B

See application file for complete search history.

(56) **References Cited**

U.S. PATENT DOCUMENTS

D533,519 S * 12/2006 Ellison D14/126
D555,611 S * 11/2007 Tako D14/126

D563,340 S * 3/2008 Hoehn et al. D14/126
D563,913 S * 3/2008 Sonoda et al. D14/126
D563,916 S * 3/2008 Shimizu et al. D14/126
D570,804 S * 6/2008 Fujiki D14/126
D573,560 S * 7/2008 Niitsu D14/126
D674,368 S * 1/2013 Yoo et al. D14/126
D676,006 S * 2/2013 Choi et al. D14/126
D691,604 S * 10/2013 Seong et al. D14/374
D697,881 S * 1/2014 Lee et al. D14/126
2013/0176509 A1* 7/2013 Ooe et al. 348/836
2013/0222707 A1* 8/2013 Kim et al. 348/836
2013/0258212 A1* 10/2013 Ooe et al. 348/836

* cited by examiner

Primary Examiner — Robert M Spear

Assistant Examiner — Eliza Bennett-Hattan

(74) *Attorney, Agent, or Firm* — Harness, Dickey & Pierce

(57) **CLAIM**

We claim the ornamental design for a TV receiver, as shown.

DESCRIPTION

FIG. 1 is a front/right-side/top perspective view of a TV receiver showing our new design;

FIG. 2 is a front-side elevational view thereof;

FIG. 3 is a rear-side elevational view thereof;

FIG. 4 is a left-side elevational view thereof;

FIG. 5 is a right-side elevational view thereof;

FIG. 6 is a top-side elevational view thereof; and,

FIG. 7 is a bottom-side elevational view thereof.

The broken lines in the drawing depict environmental subject matter only and form no part of the claimed design.

1 Claim, 6 Drawing Sheets

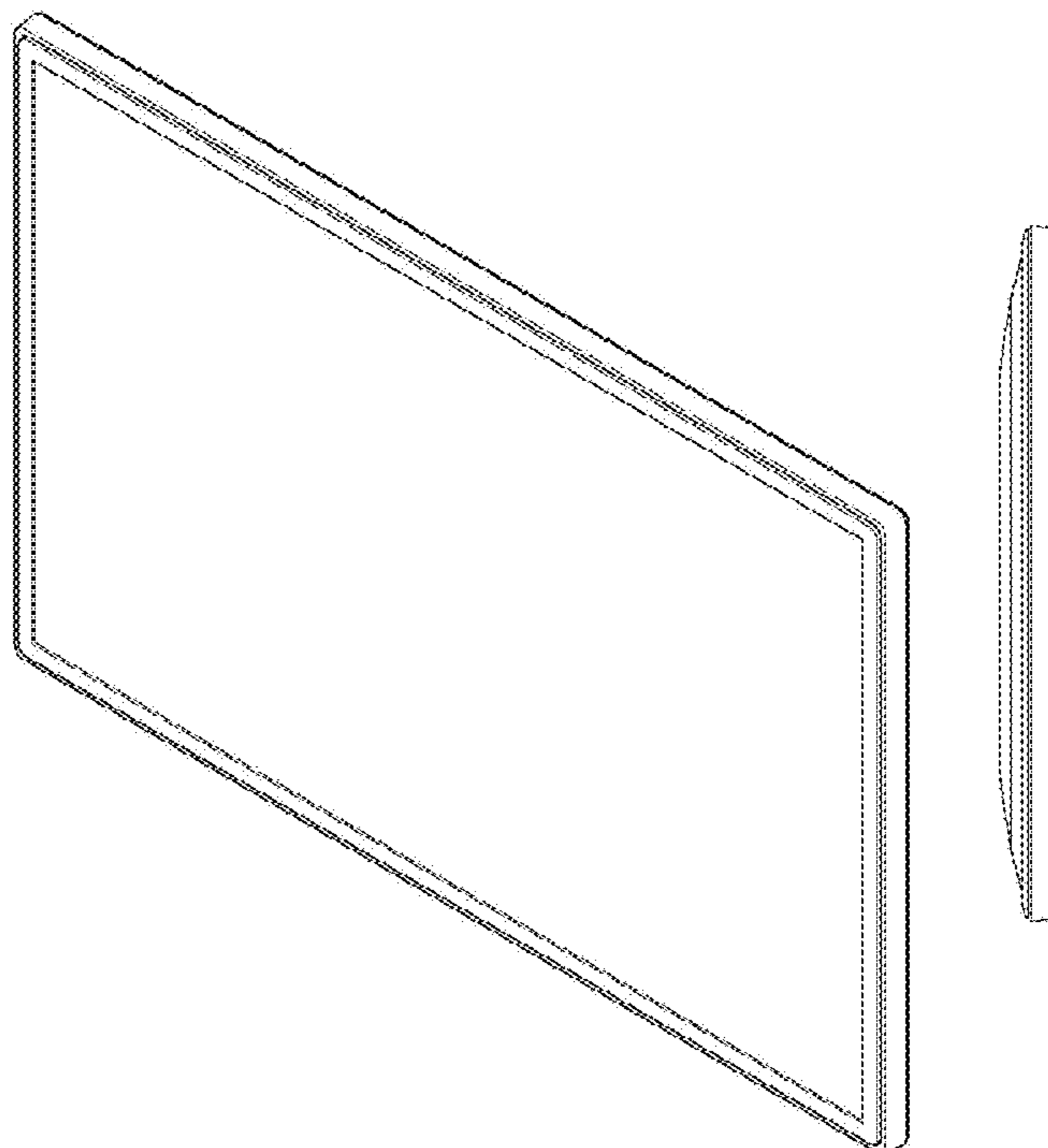

FIG. 1

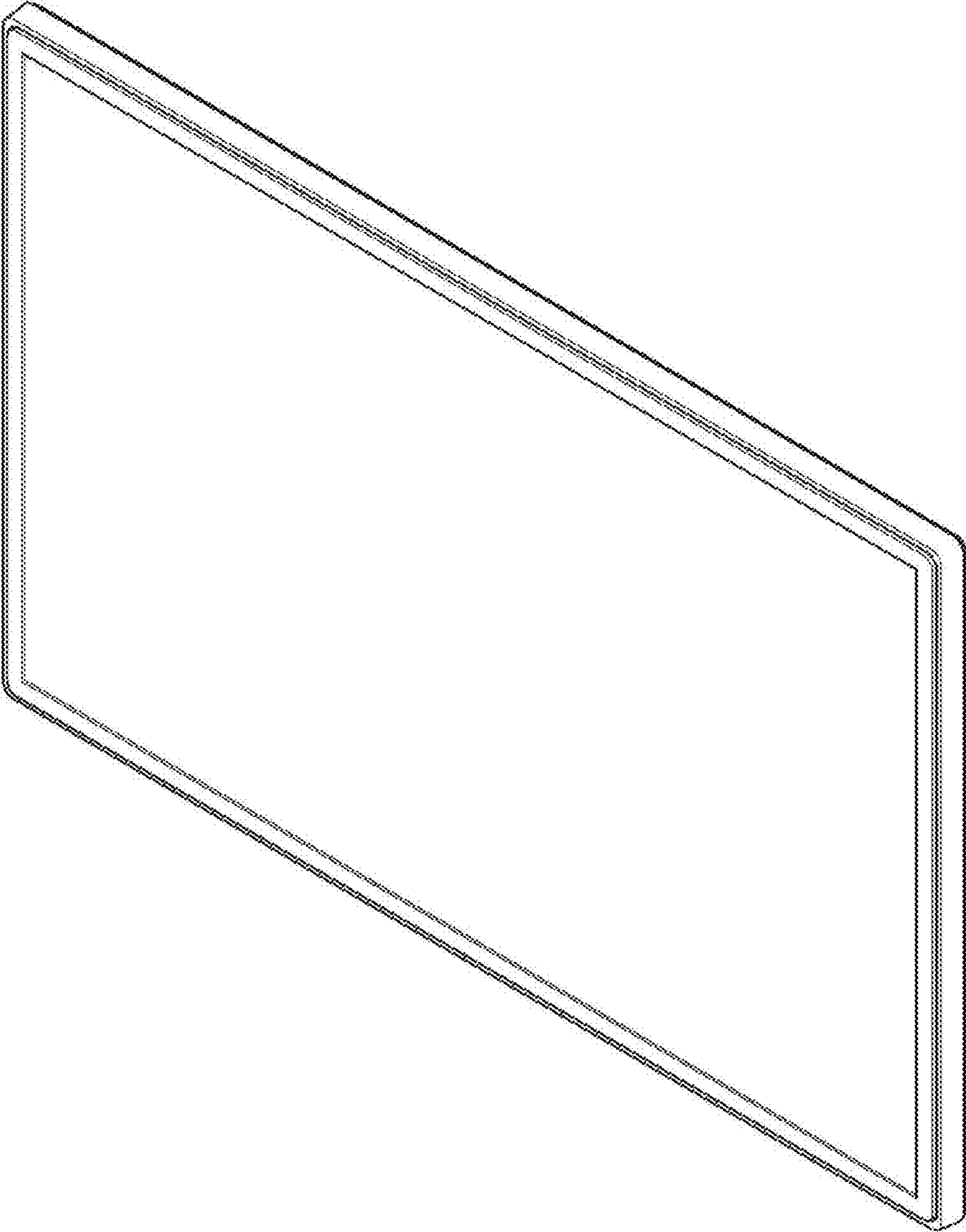

FIG. 2

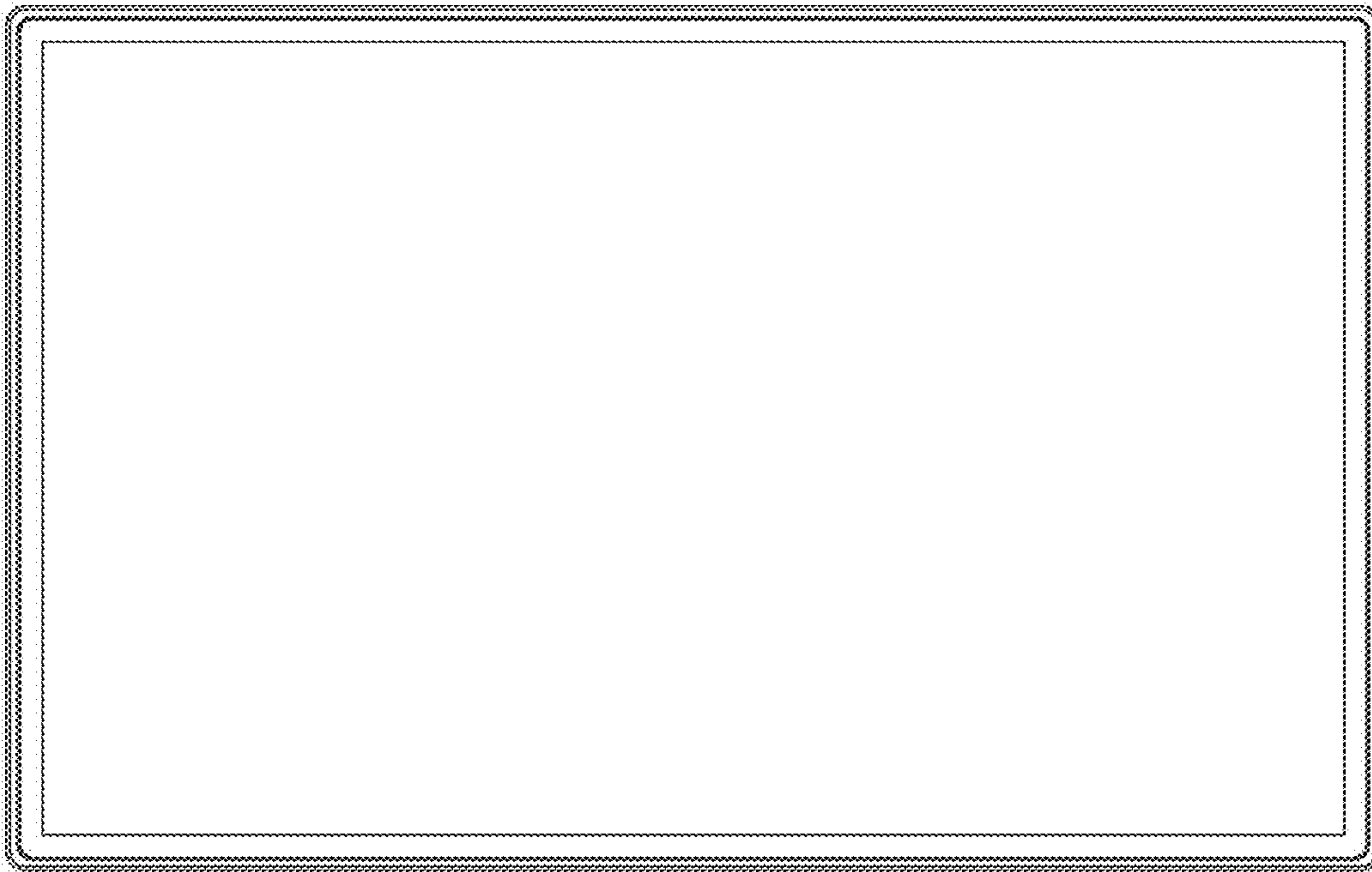

FIG. 3

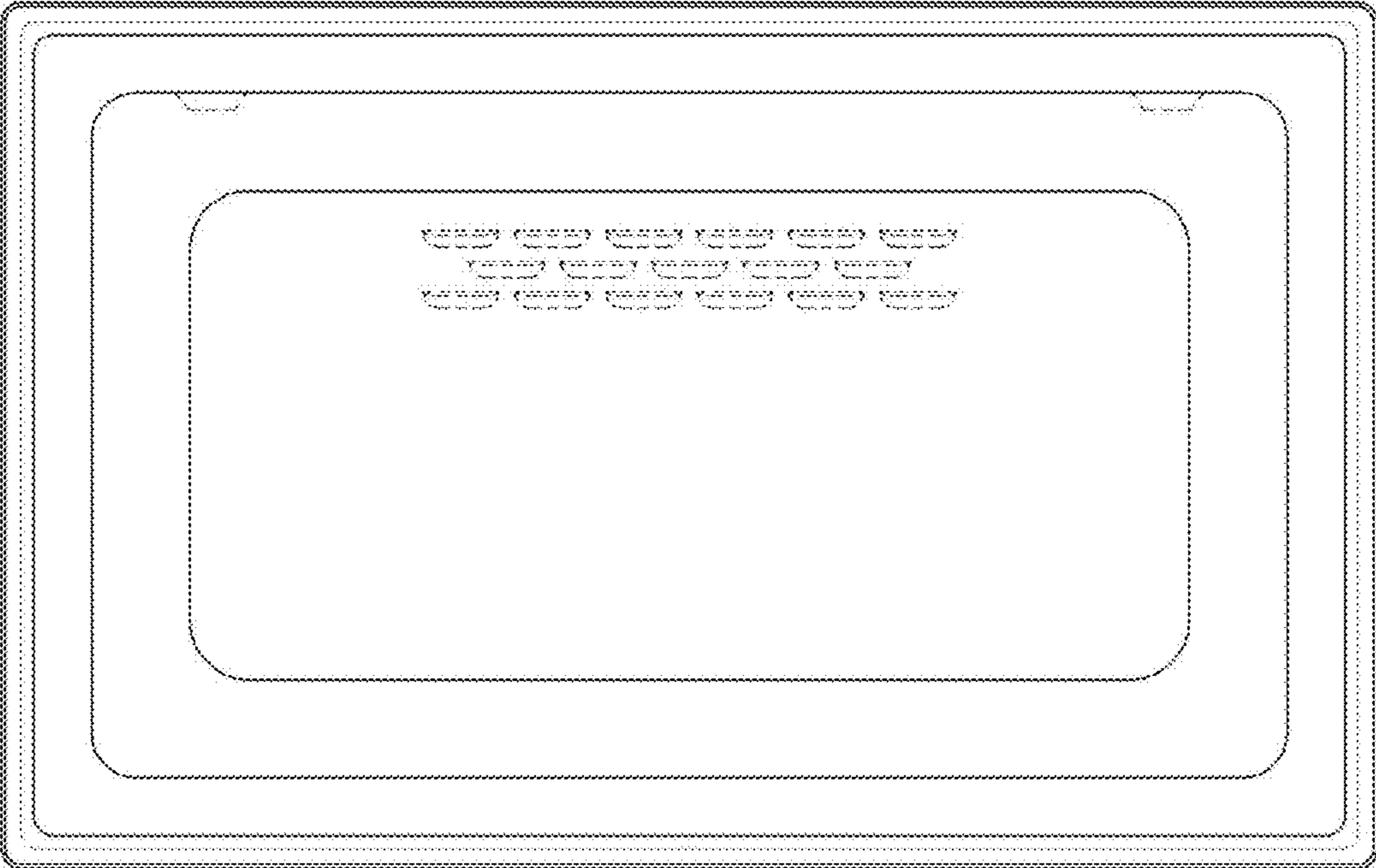

FIG. 4

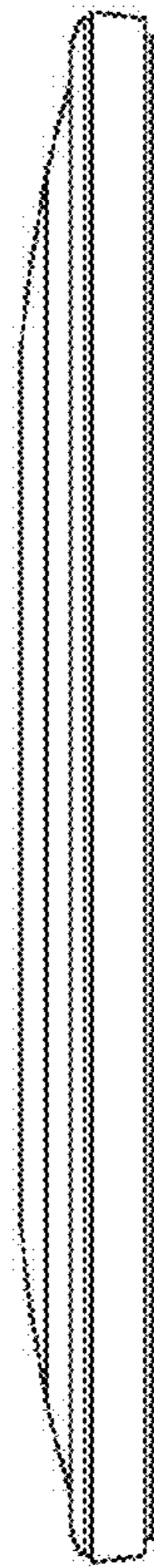

FIG. 5

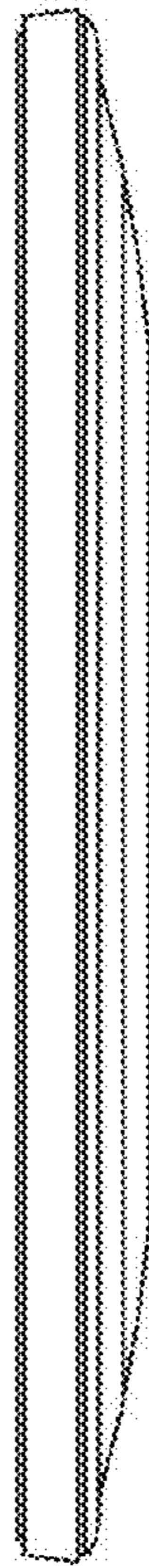

FIG. 6

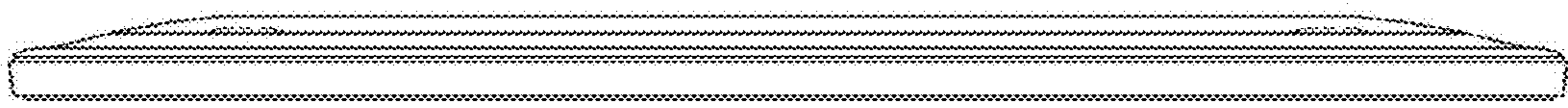

FIG. 7

