



US00D714459S

(12) **United States Design Patent**
Develon

(10) **Patent No.:** **US D714,459 S**

(45) **Date of Patent:** **** Sep. 30, 2014**

(54) **PERISTALTIC PUMP FOR BIOLOGICAL
DEVICE**

(71) Applicant: **bioMérieux**, Marcy-l'Etoile (FR)

(72) Inventor: **Johan Develon**, Chavagne (FR)

(73) Assignee: **bioMérieux**, Marcy l'Etoile (FR)

(**) Term: **14 Years**

(21) Appl. No.: **29/453,486**

(22) Filed: **Apr. 30, 2013**

(51) **LOC (10) Cl.** **24-01**

(52) **U.S. Cl.**
USPC **D24/216**

(58) **Field of Classification Search**
USPC D24/216, 217, 219, 223, 231, 232, 233,
D24/107, 169, 186, 111; D10/81; 422/500,
422/547, 62-65, 67; 435/287.1, 287.3;
436/43, 45, 47

See application file for complete search history.

(56) **References Cited**

U.S. PATENT DOCUMENTS

5,096,669	A *	3/1992	Lauks et al.	600/345
D361,617	S *	8/1995	Sancoff et al.	D24/129
D645,977	S *	9/2011	Oonuma et al.	D24/232
D674,083	S *	1/2013	Boaz	D24/111
D691,711	S *	10/2013	Lofgren	D24/232
D693,712	S *	11/2013	Noda et al.	D24/232

* cited by examiner

Primary Examiner — Anhdao Doan

(74) *Attorney, Agent, or Firm* — Winstead PC

(57) **CLAIM**

The ornamental design for a peristaltic pump for biological device, as shown and described.

DESCRIPTION

FIG. 1 is a perspective view of a peristaltic pump for biological device in accordance with the design;
FIG. 2 is a front view thereof;
FIG. 3 is a back view thereof;
FIG. 4 is a left side view thereof;
FIG. 5 is a right side view thereof;
FIG. 6 is a top plan view thereof; and,
FIG. 7 is a bottom plan view thereof.
Any broken lines present in the drawings are for illustrative purposes only and form no part of the design to be patented.

1 Claim, 6 Drawing Sheets

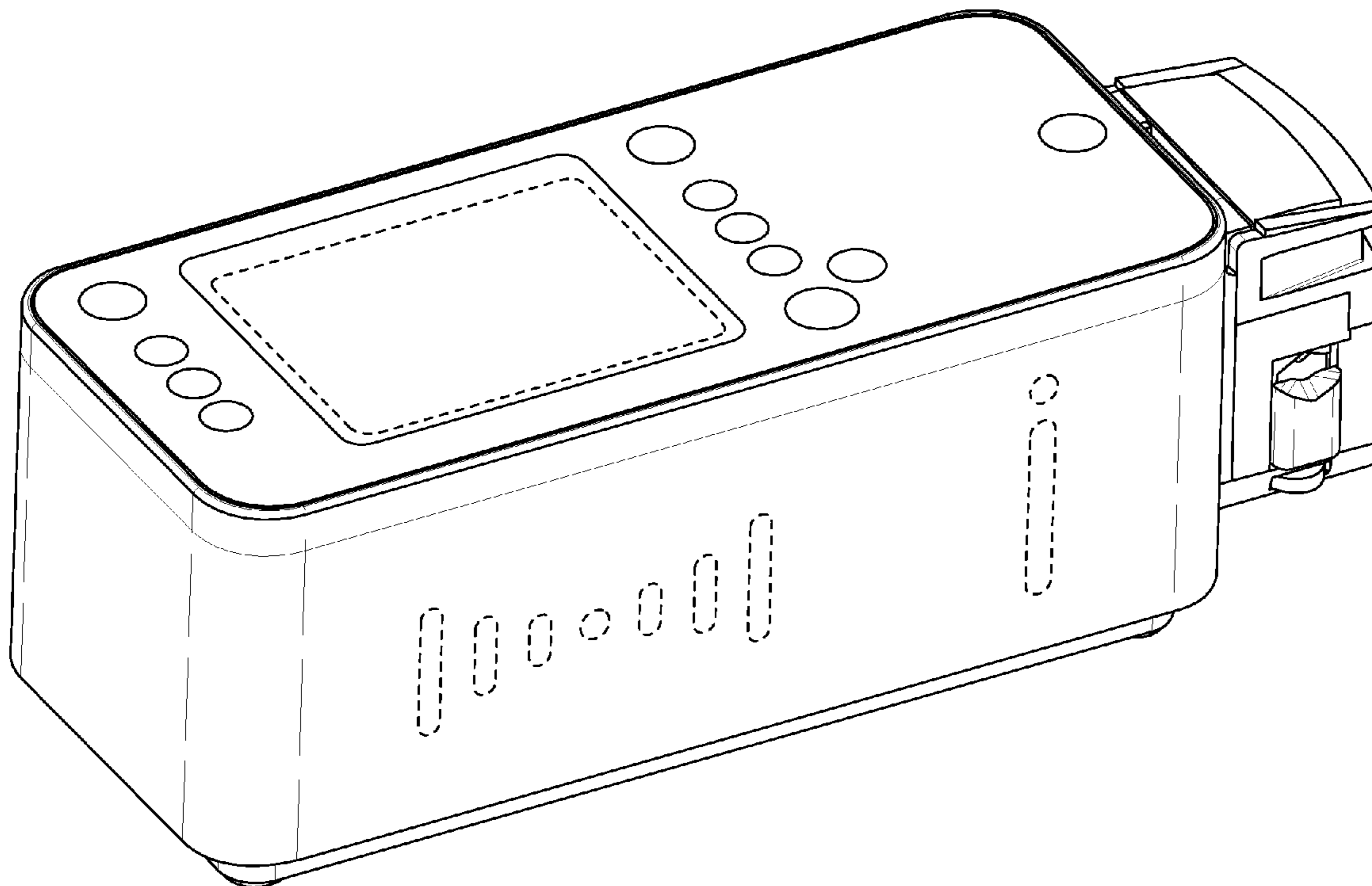

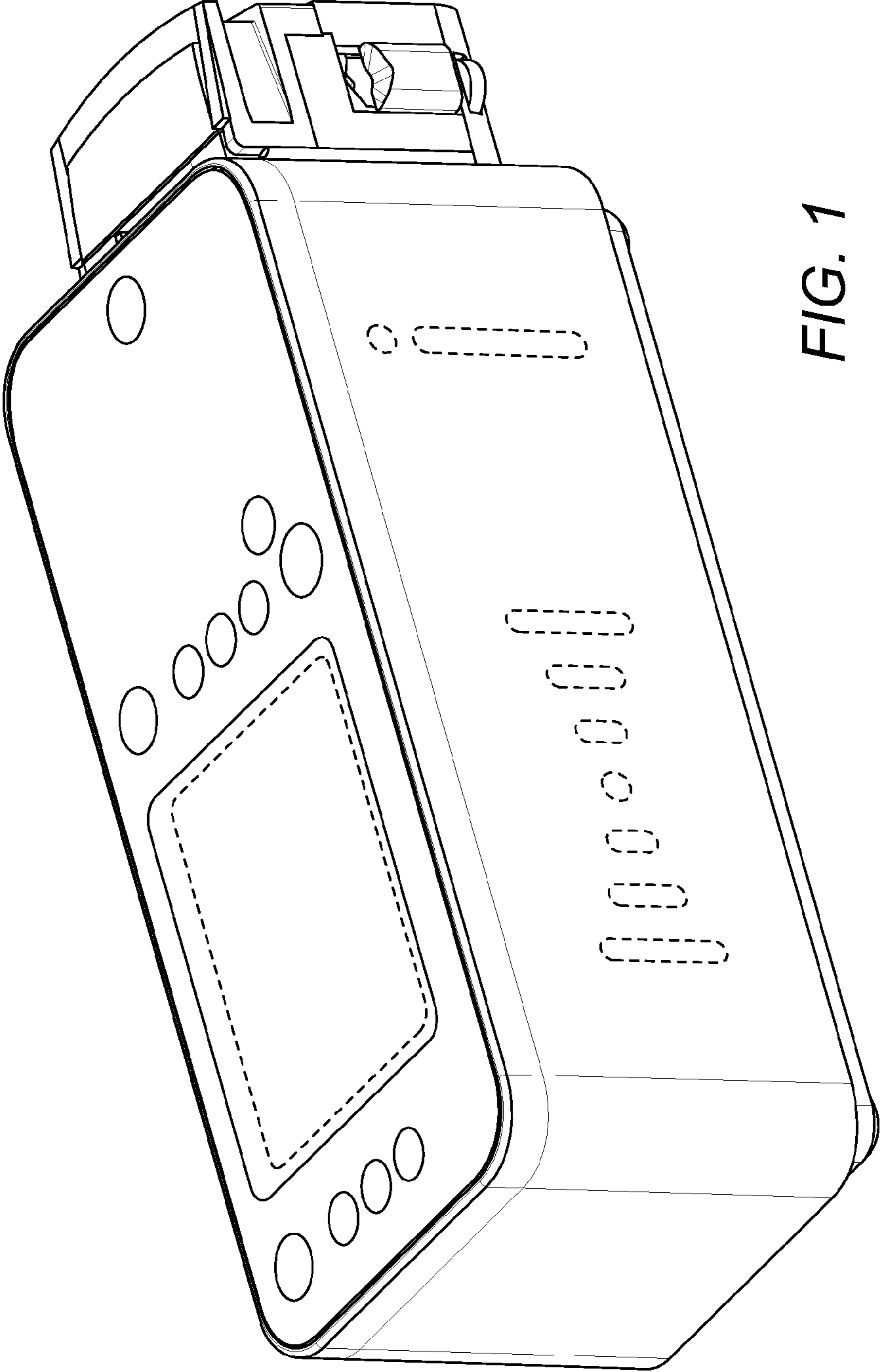

FIG. 1

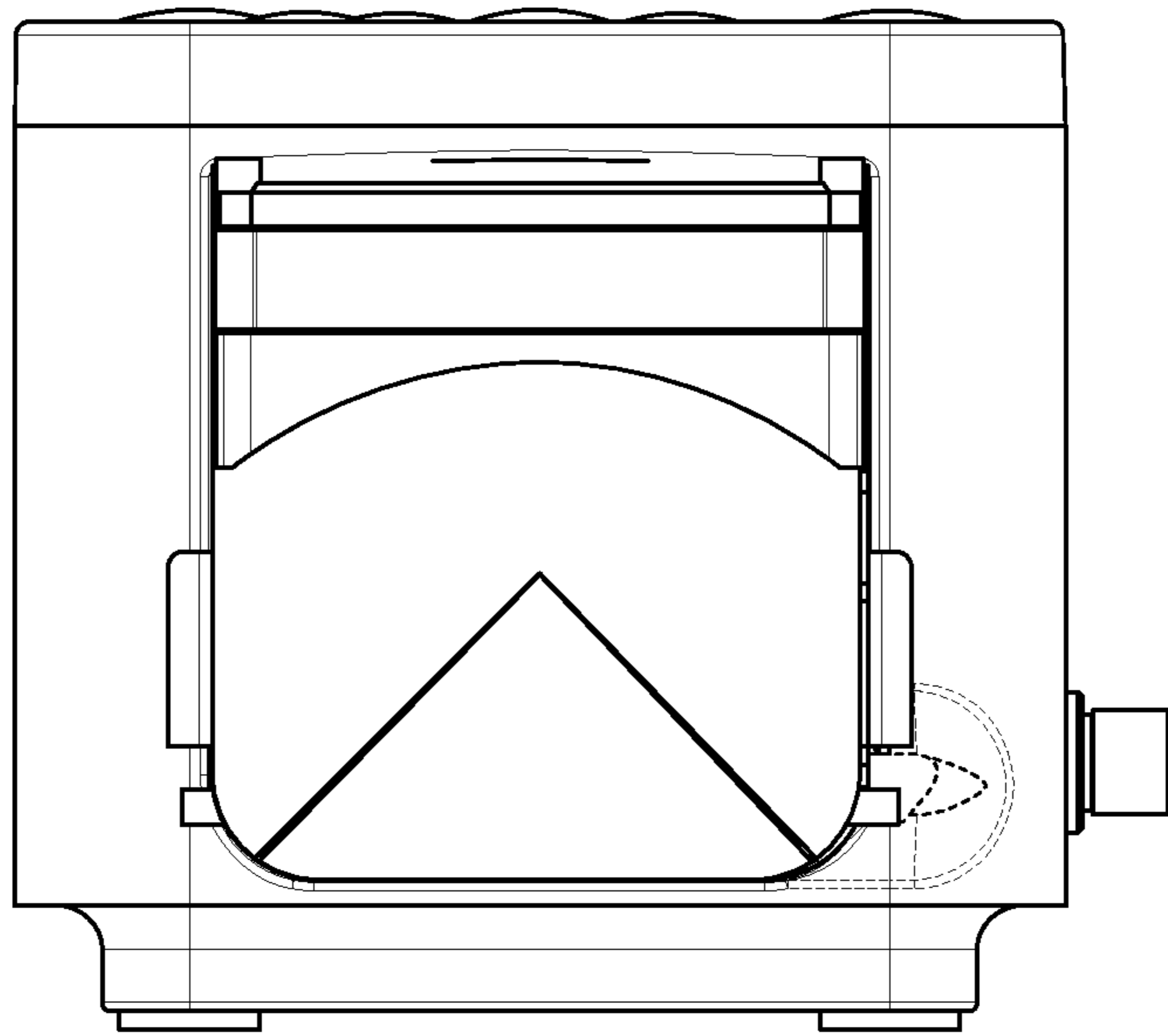

FIG. 2

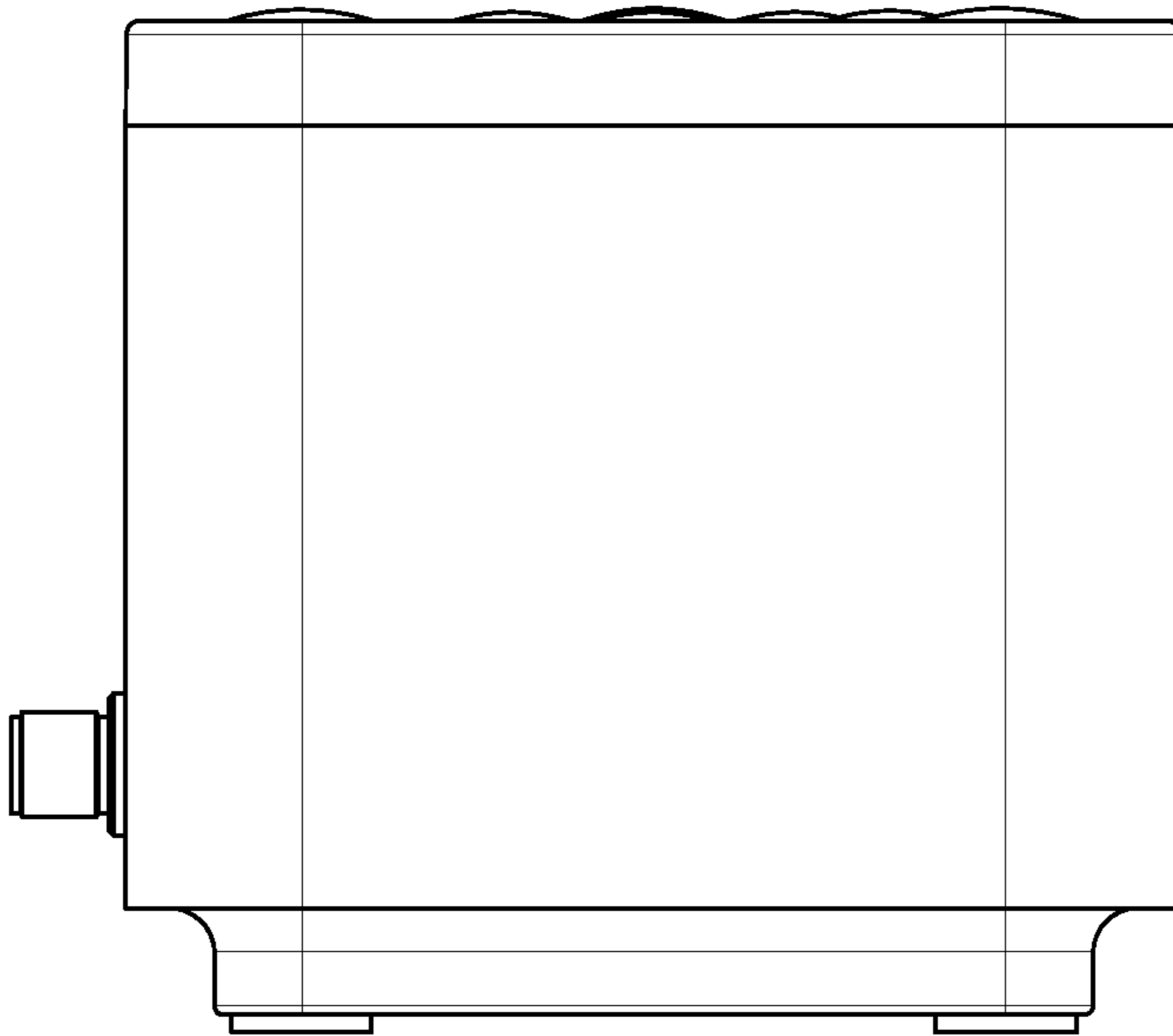

FIG. 3

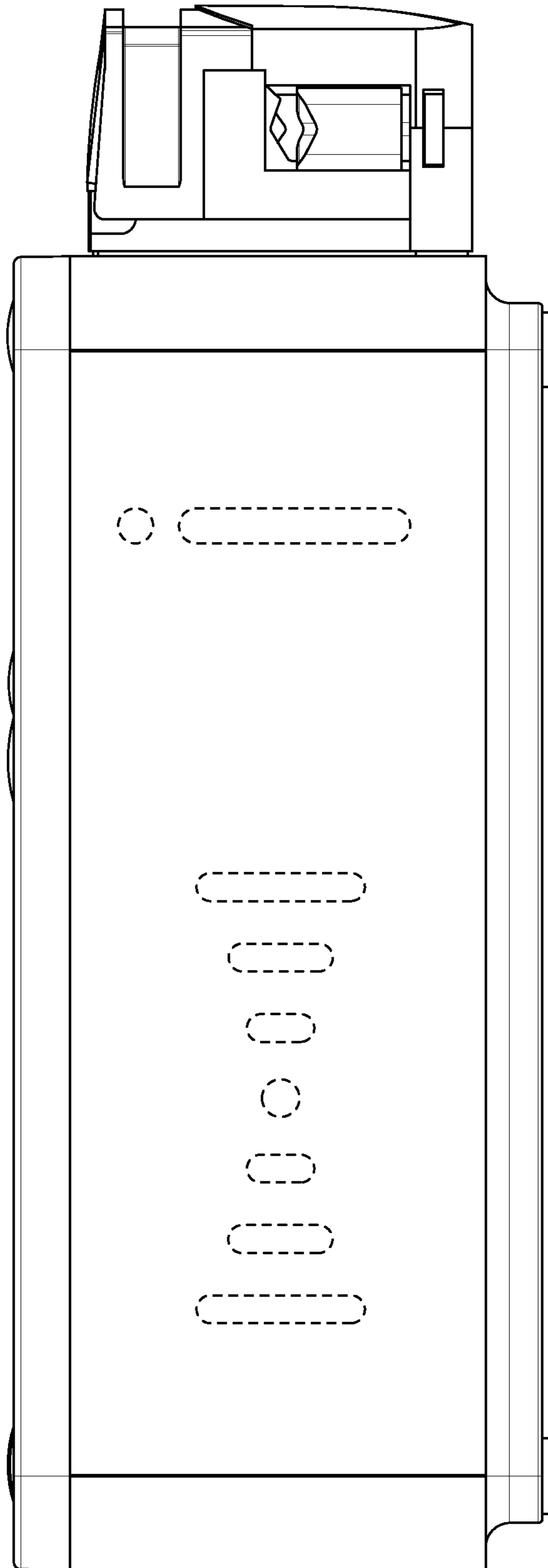

FIG. 4

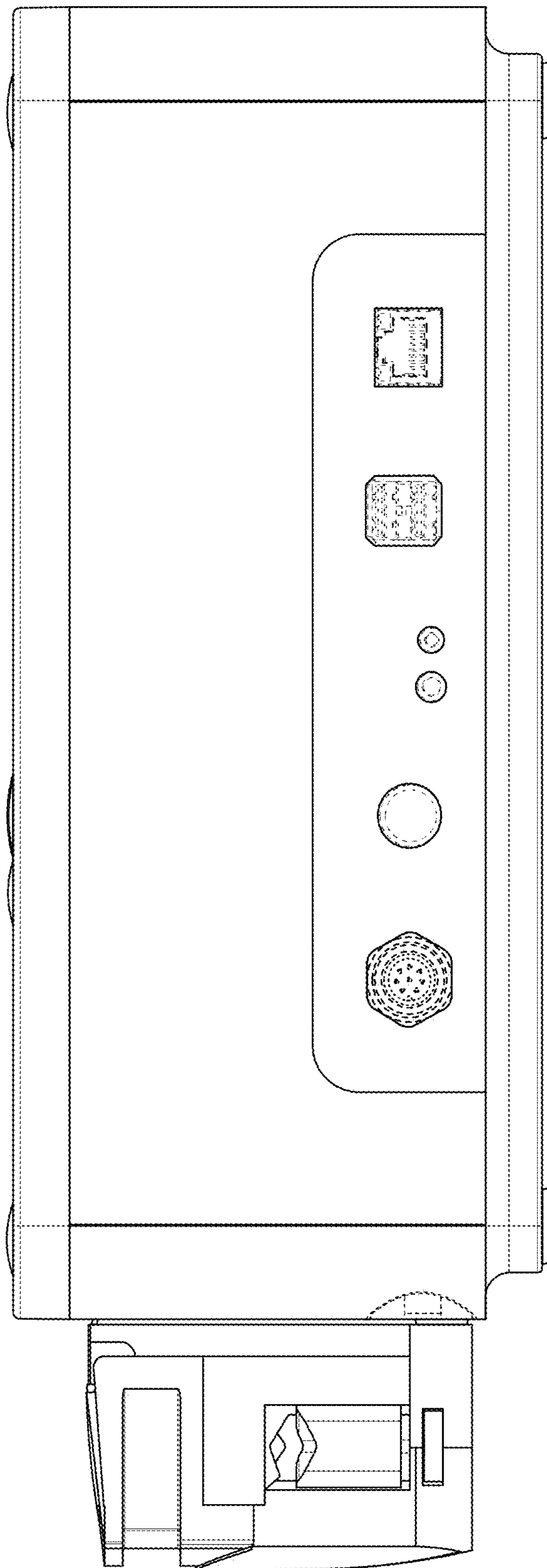

FIG. 5

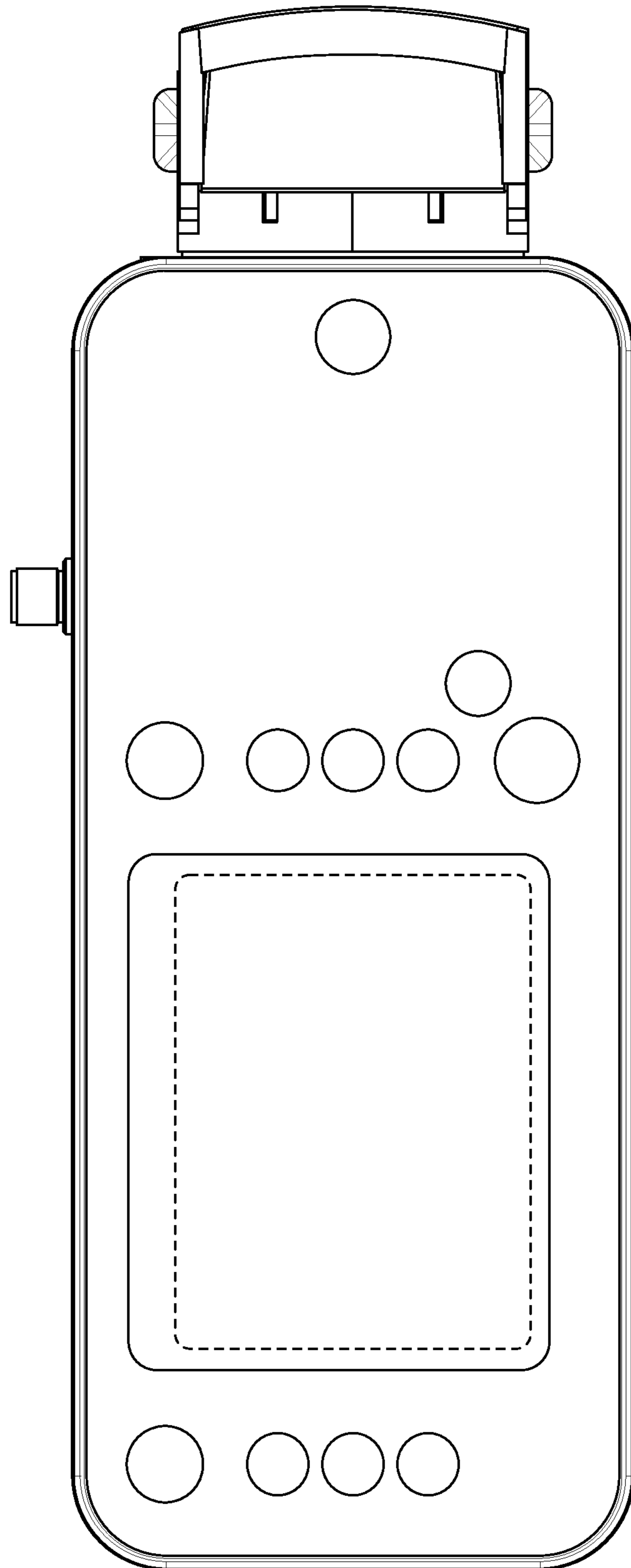

FIG. 6

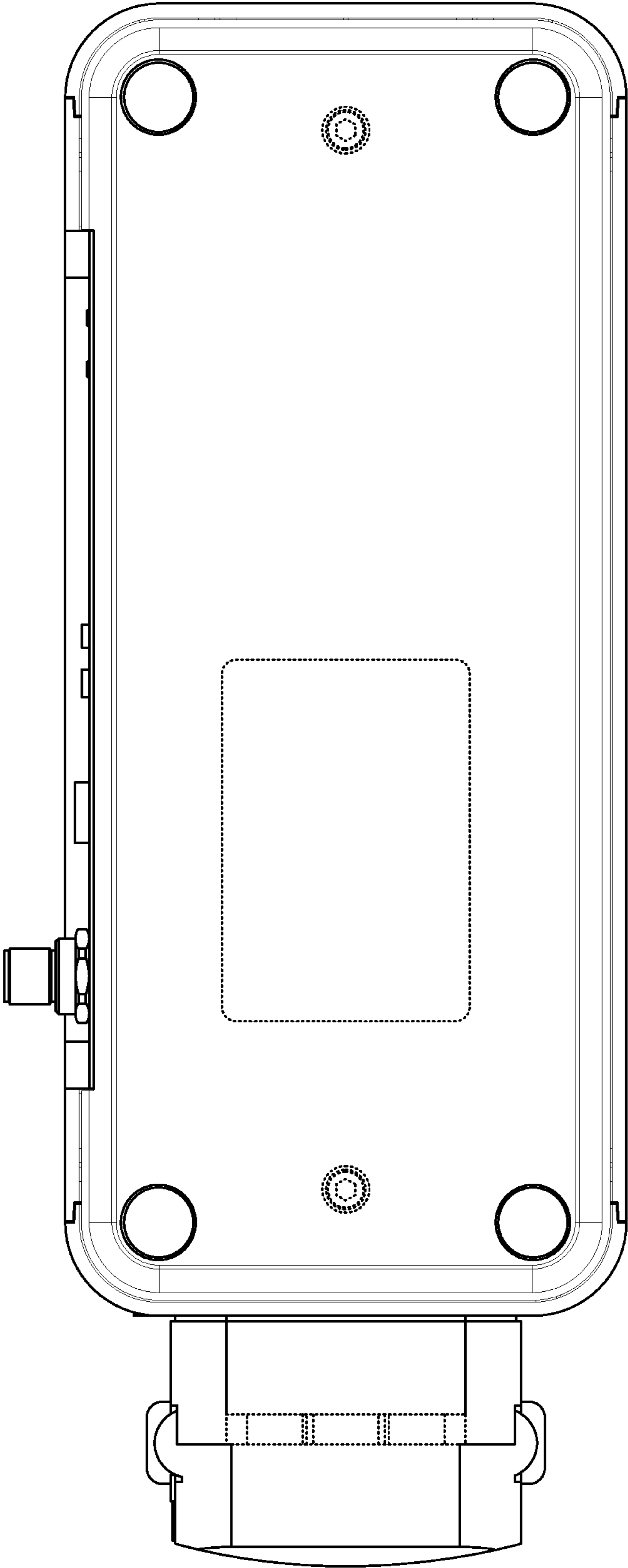

FIG. 7