



US00D714222S

(12) **United States Design Patent**
Huang

(10) **Patent No.:** **US D714,222 S**

(45) **Date of Patent:** **** Sep. 30, 2014**

(54) **CAR USB CHARGER**

(56) **References Cited**

(71) Applicant: **Oxerer Technologies Co., Ltd.**, Taipei (TW)

U.S. PATENT DOCUMENTS

(72) Inventor: **Po-Chin Huang**, Taipei (TW)

5,116,248	A	*	5/1992	Hiers et al.	439/669
D330,887	S	*	11/1992	Wharton	D13/144
D398,287	S	*	9/1998	Luminosu	D13/144
5,964,623	A	*	10/1999	Maher et al.	439/668
6,612,875	B1	*	9/2003	Liao	439/675
D620,441	S	*	7/2010	Hou	D13/144
D622,218	S	*	8/2010	Tseng et al.	D13/144
D655,246	S	*	3/2012	Fitch et al.	D13/144
D684,930	S	*	6/2013	Wang	D13/144

(73) Assignee: **Oxerer Technologies Co., Ltd.**, Taipei (TW)

(**) Term: **14 Years**

* cited by examiner

(21) Appl. No.: **29/481,696**

Primary Examiner — Derrick Holland

(22) Filed: **Feb. 10, 2014**

(74) *Attorney, Agent, or Firm* — Rosenberg, Klein & Lee

(30) **Foreign Application Priority Data**

(57) **CLAIM**

Aug. 12, 2013 (TW) 102305463

The ornamental design for a car USB charger, as shown and described.

(51) **LOC (10) Cl.** **13-03**

DESCRIPTION

(52) **U.S. Cl.**
USPC **D13/144**

FIG. 1 is a front, bottom, and left side perspective view of a car USB charger showing my new design;
FIG. 2 is a top plan view thereof;
FIG. 3 is a bottom plan view thereof;
FIG. 4 is a left side elevational view thereof;
FIG. 5 is a right side elevational view thereof;
FIG. 6 is a front elevational view thereof; and,
FIG. 7 is a rear elevational view thereof.

(58) **Field of Classification Search**
USPC D13/144, 101, 107, 108, 110, 118, 119,
D13/133, 184, 199; D14/155, 432, 434,
D14/435.1, 356, 480.1, 480.7; 320/107,
320/108, 109, 110, 111, 112, 113, 114,
320/115; 439/300, 620.01, 638, 668, 669,
439/675, 825; 363/146

See application file for complete search history.

1 Claim, 7 Drawing Sheets

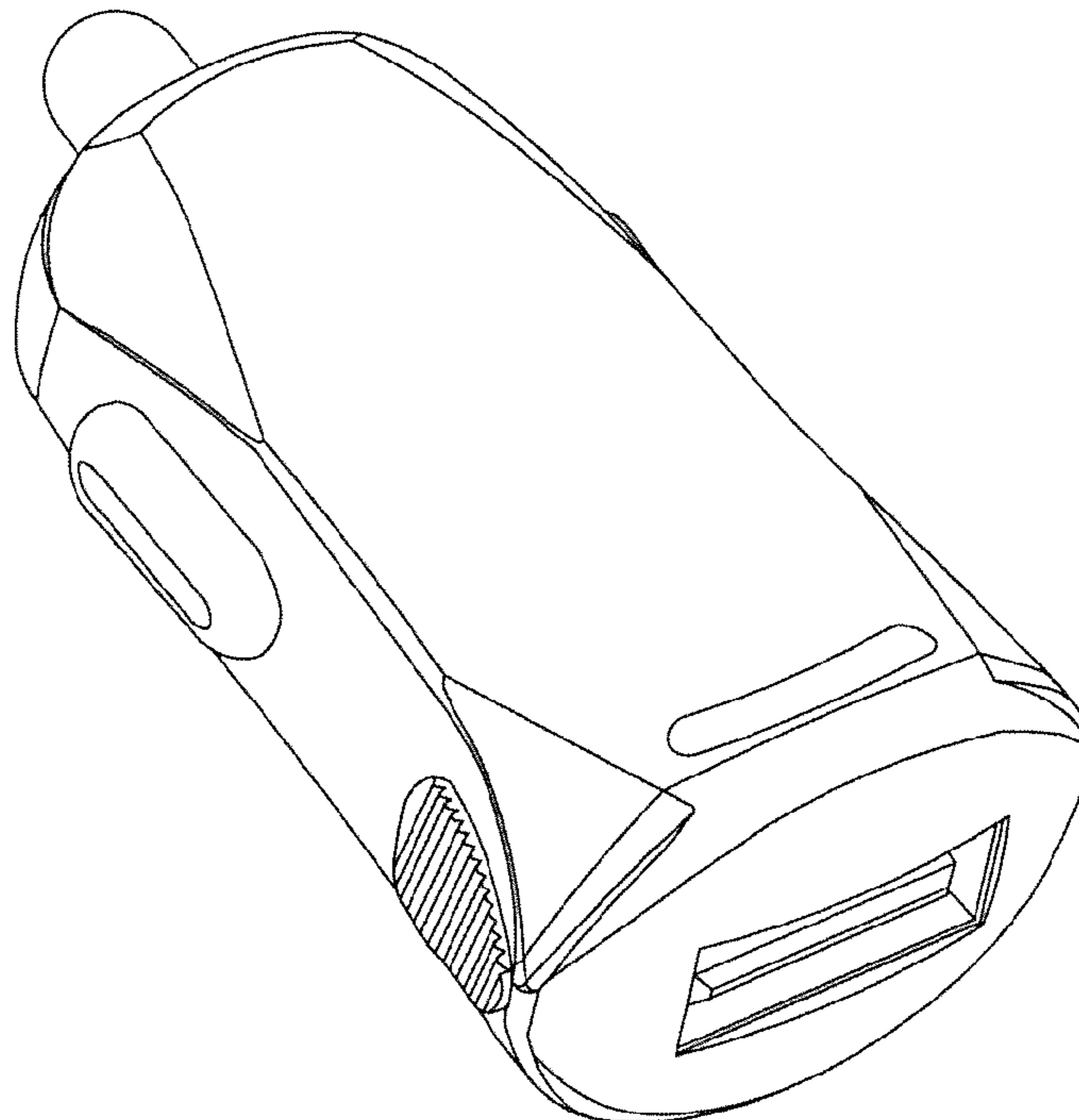

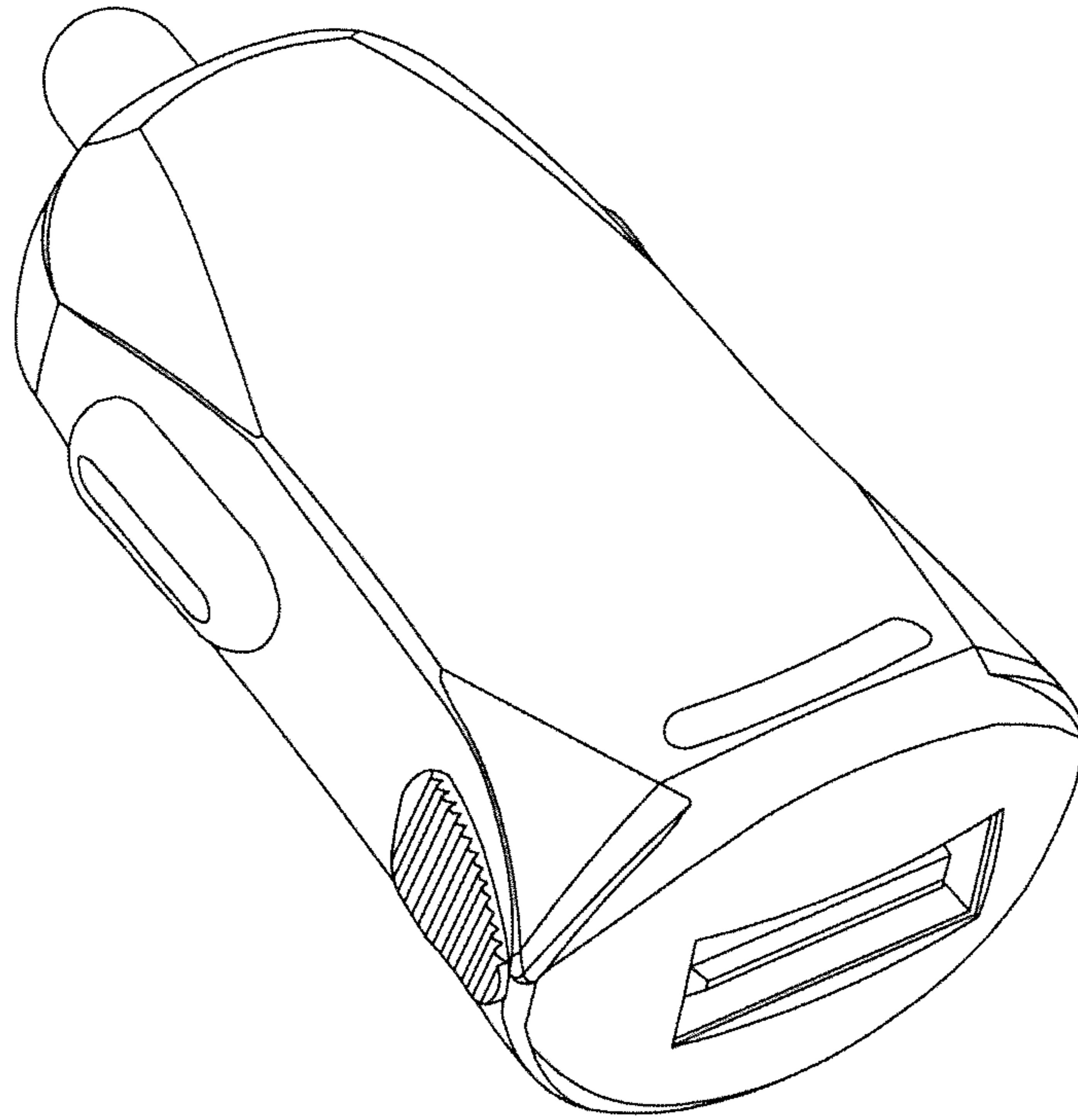

FIG. 1

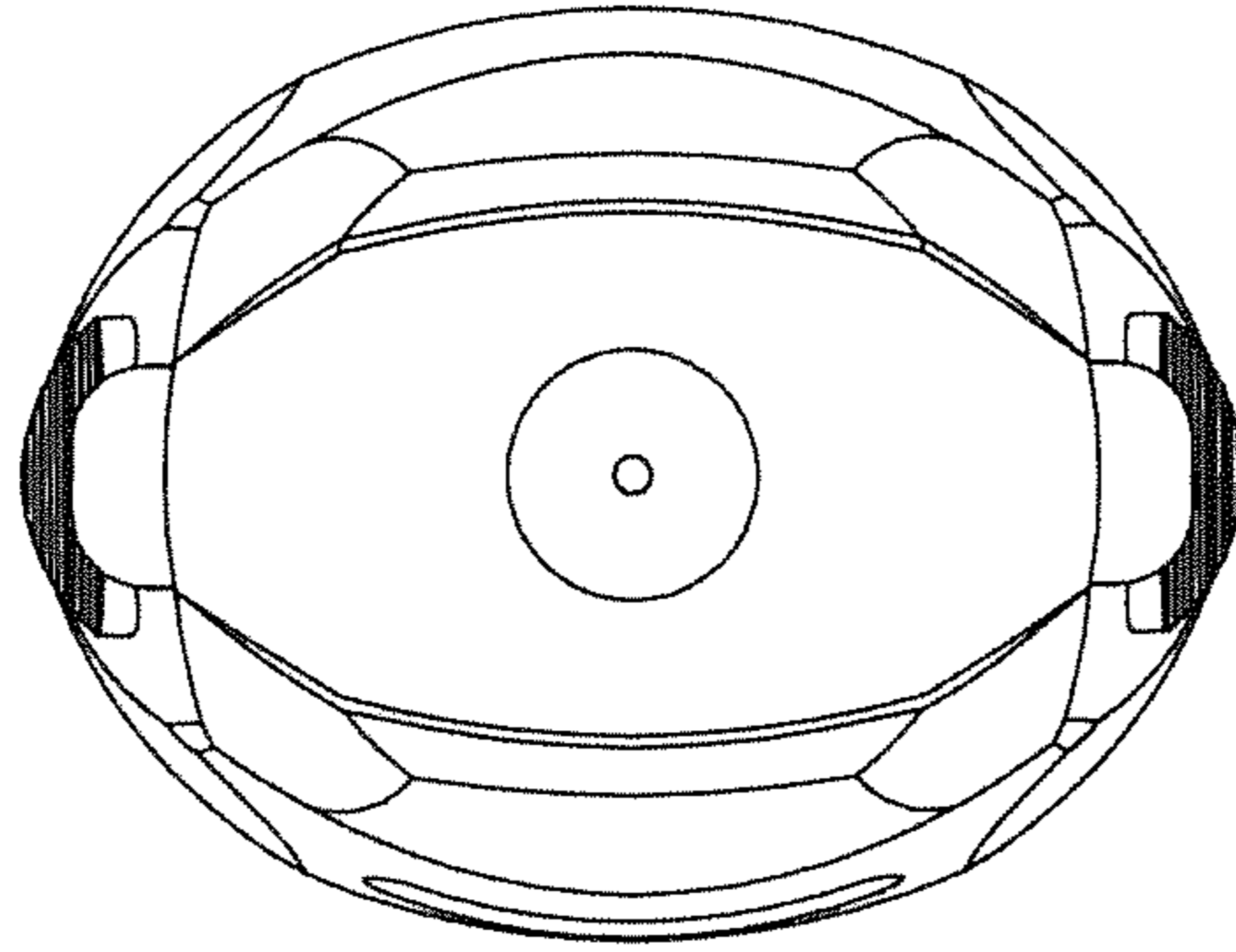

FIG. 2

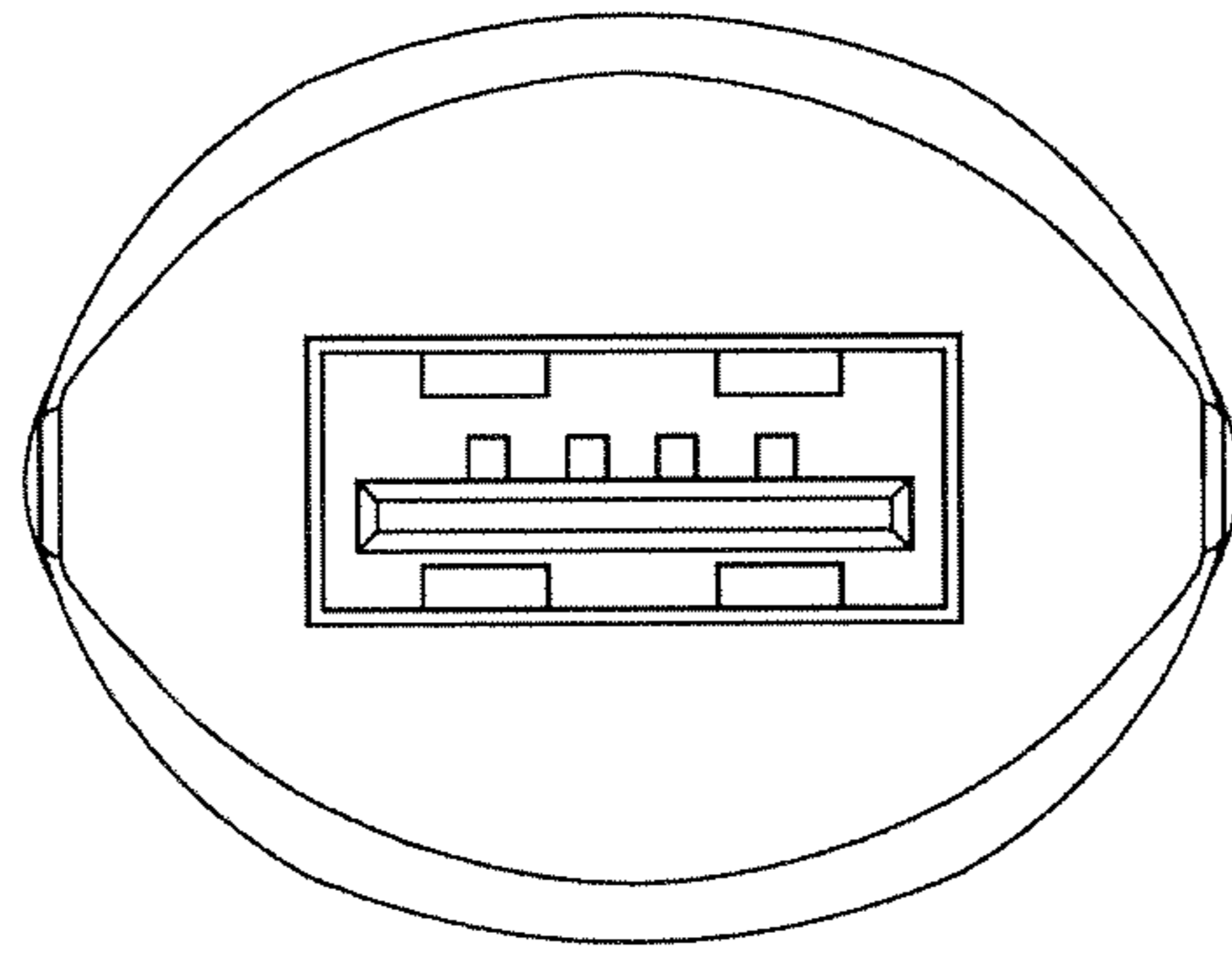

FIG. 3

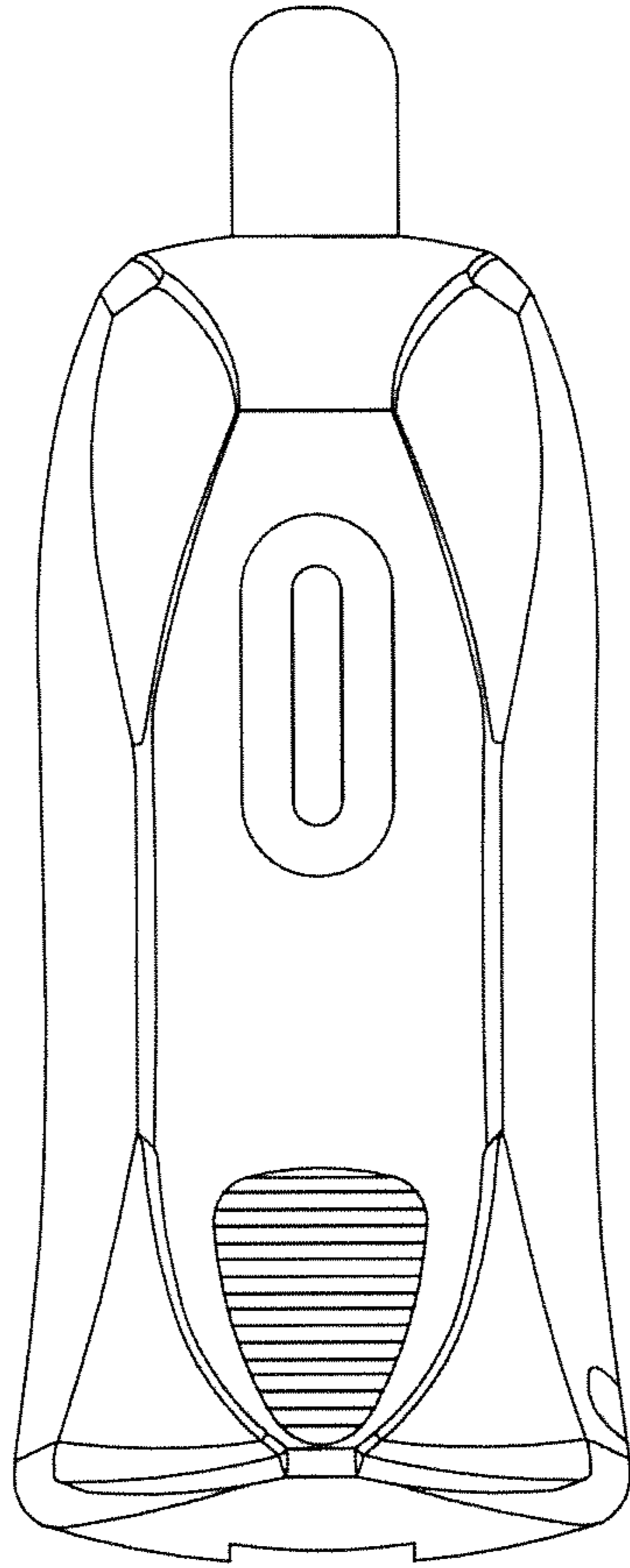

FIG. 4

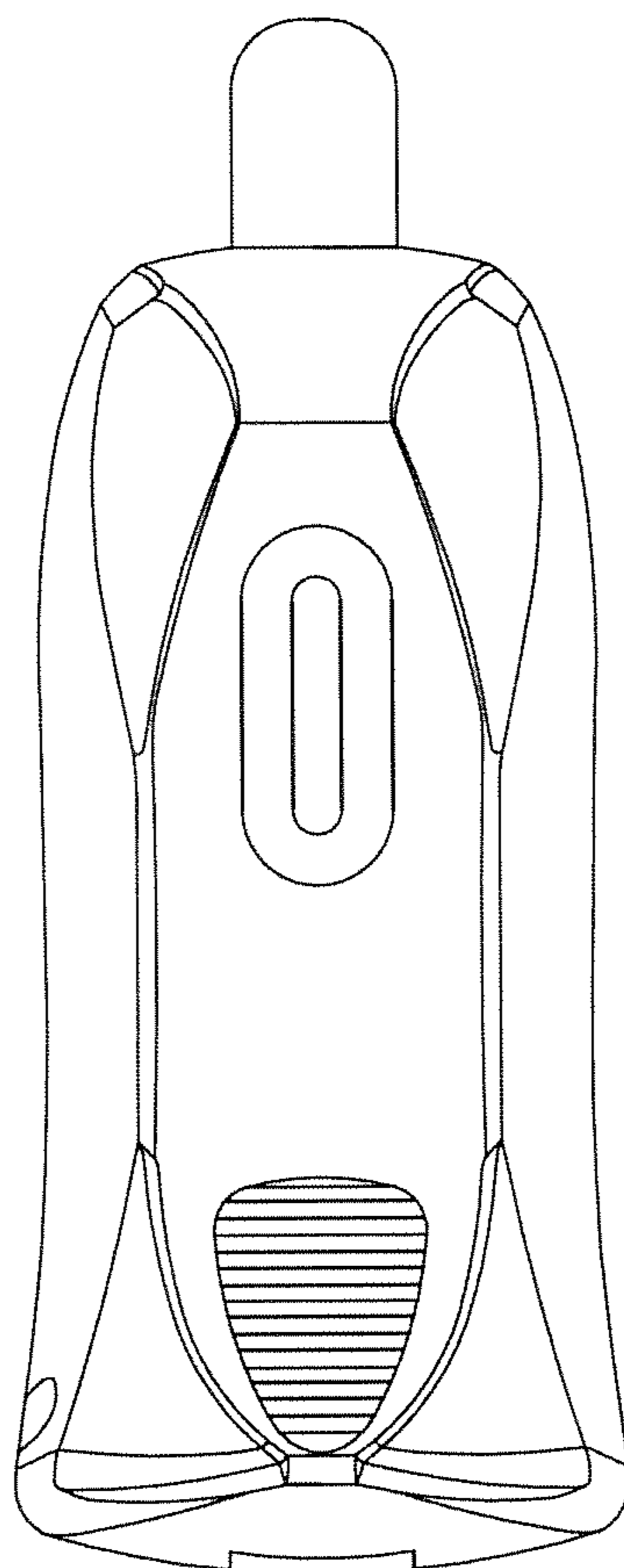

FIG. 5

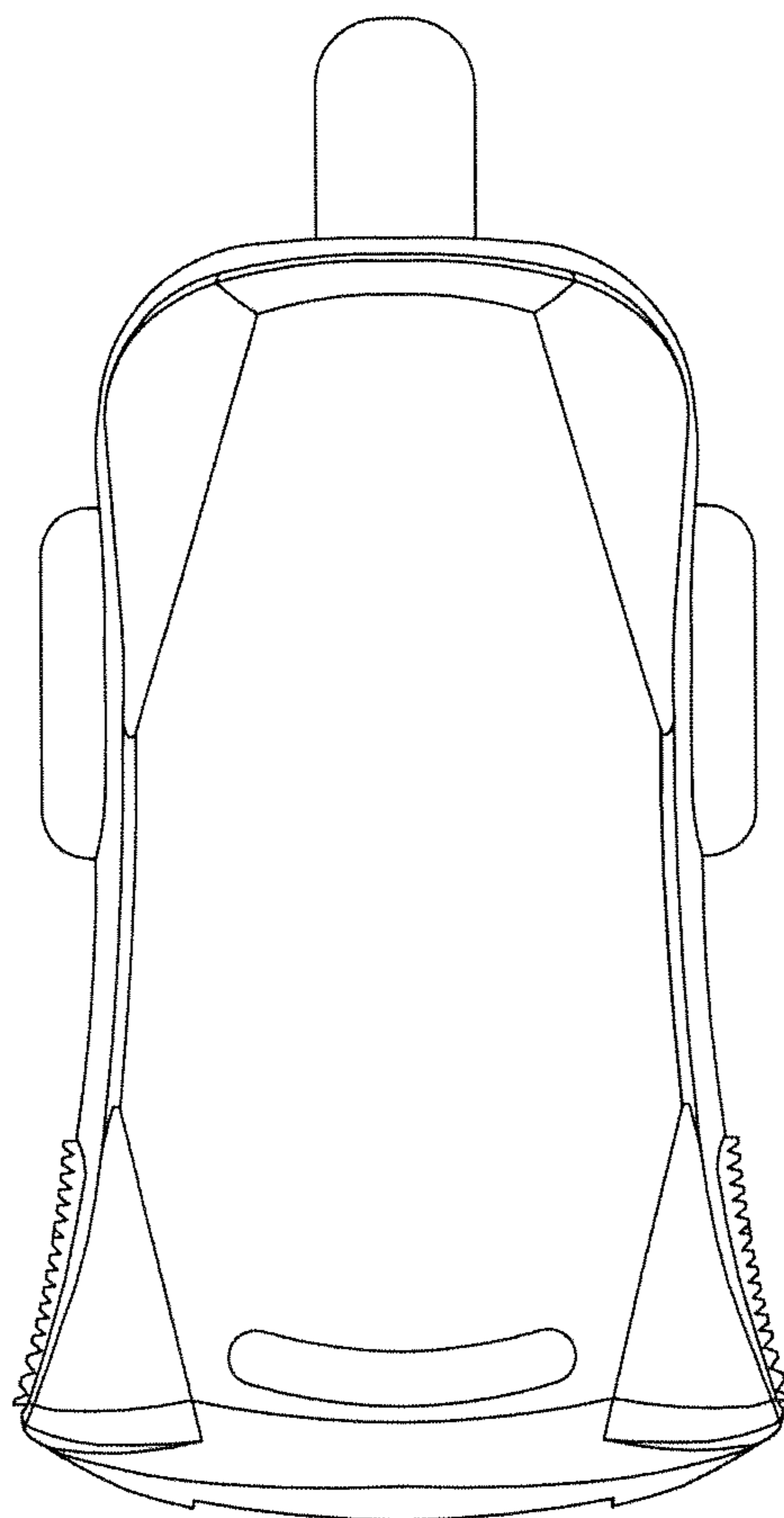

FIG. 6

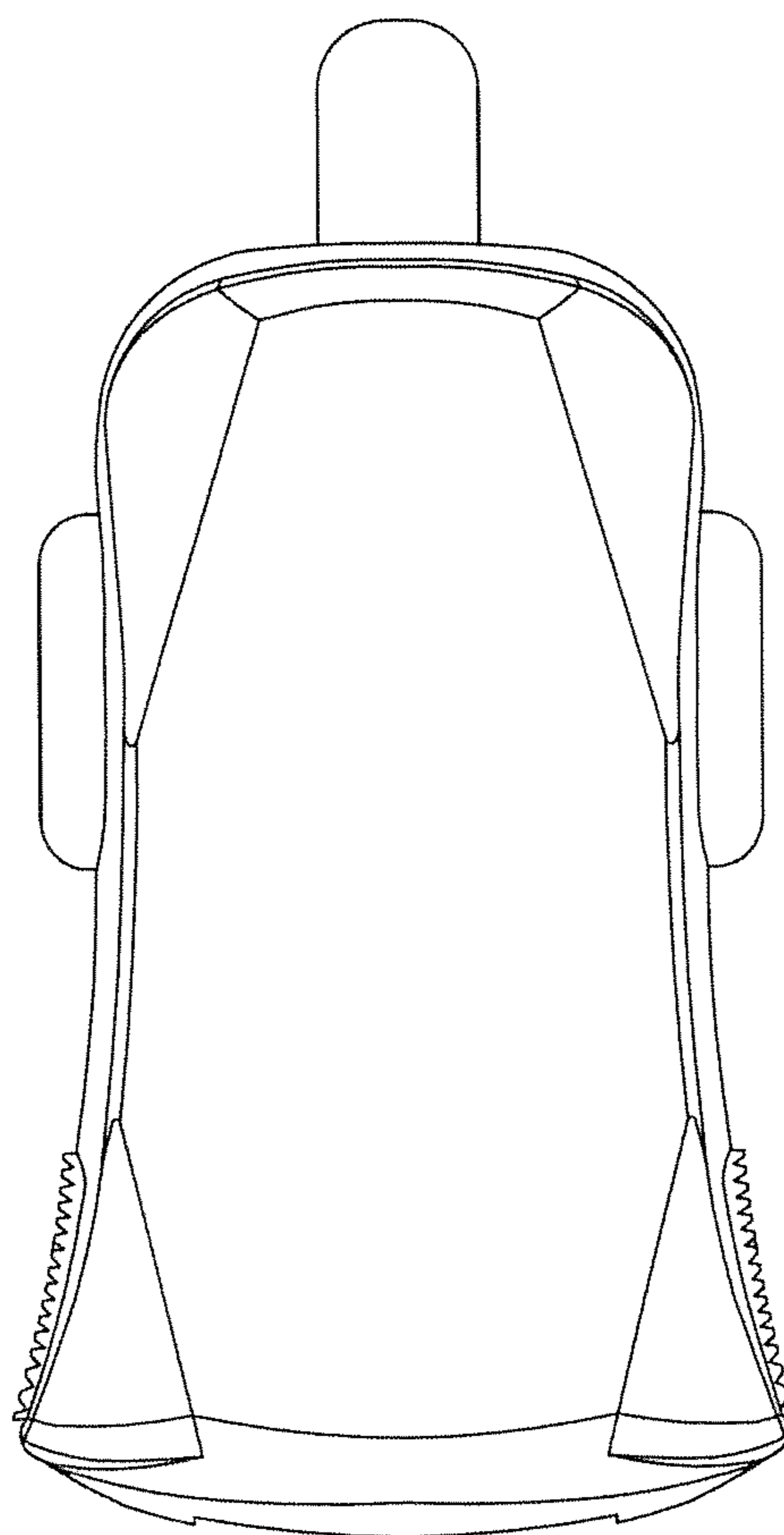

FIG. 7