



US00D714160S

(12) **United States Design Patent**  
**Park**

(10) **Patent No.:** **US D714,160 S**

(45) **Date of Patent:** **\*\* Sep. 30, 2014**

(54) **COSMETIC CONTAINER**

(71) Applicant: **Amorepacific Corporation**, Seoul (KR)

(72) Inventor: **Kyung Mi Park**, Seoul (KR)

(73) Assignee: **Amorepacific Corporation**, Seoul (KR)

(\*\*) Term: **14 Years**

(21) Appl. No.: **29/462,197**

(22) Filed: **Jul. 31, 2013**

(30) **Foreign Application Priority Data**

Feb. 1, 2013 (KR) ..... 30-2013-0005712

(51) **LOC (10) Cl.** ..... **09-01**

(52) **U.S. Cl.**  
USPC ..... **D9/688**

(58) **Field of Classification Search**

USPC ..... D9/682-694, 500-505, 519, 544-546,  
D9/549-558, 434-436, 439, 445, 448,  
D9/454; 215/379, 382; 220/376, 377, 662,  
220/665, 669; 222/153.11, 153.12, 153.13,  
222/153.14, 173, 182, 183, 321.1, 321.6,  
222/321.7, 321.8, 325-327, 372, 378, 382,  
222/383.1, 402.11, 402.13

See application file for complete search history.

(56) **References Cited**

**U.S. PATENT DOCUMENTS**

D200,609 S \* 3/1965 Fahlstrom ..... D9/448  
D215,698 S \* 10/1969 Jordan et al. .... D9/688  
D218,553 S \* 9/1970 Nigro ..... D9/688  
D385,793 S \* 11/1997 Marsal ..... D9/503  
D402,542 S \* 12/1998 Meshberg ..... D9/688  
D580,778 S \* 11/2008 Konckier ..... D9/694  
D584,638 S \* 1/2009 Castelnovo-Tedesco .... D9/686

D599,675 S \* 9/2009 Premo ..... D9/687  
D613,604 S \* 4/2010 Rowland et al. .... D9/504  
D621,277 S \* 8/2010 Yeo ..... D9/686  
D641,250 S \* 7/2011 Daniels et al. .... D9/666  
8,308,029 B2 \* 11/2012 Ki ..... 222/309  
D688,138 S \* 8/2013 Kim ..... D9/690  
D698,662 S \* 2/2014 Kim ..... D9/689  
D703,052 S \* 4/2014 Park ..... D9/503  
2009/0302062 A1 \* 12/2009 Maddy ..... 222/183

**FOREIGN PATENT DOCUMENTS**

KR 300387082.0000 \* 7/2005  
KR 300420006.0000 \* 7/2006  
KR 300422986.0000 \* 8/2006  
KR 300429311.0001 \* 11/2006  
KR 300542291.0000 \* 10/2009  
KR 300542294.0000 \* 10/2009  
KR 300289290.0004 \* 11/2009  
KR 300591535.0000 \* 3/2011  
KR 300620583.0000 \* 11/2011

\* cited by examiner

*Primary Examiner* — Catherine Tuttle

(74) *Attorney, Agent, or Firm* — Ohlandt, Greeley, Ruggiero & Perle, L.L.P.

(57) **CLAIM**

The ornamental design for a cosmetic container, as shown and described.

**DESCRIPTION**

FIG. 1 is a top and front perspective view of the cosmetic container showing my new design;  
FIG. 2 is a front elevation view thereof;  
FIG. 3 is a rear elevation view thereof;  
FIG. 4 is a left side elevation view thereof;  
FIG. 5 is a right side elevation view thereof;  
FIG. 6 is a top plan view thereof; and,  
FIG. 7 is a bottom plan view thereof.

**1 Claim, 7 Drawing Sheets**

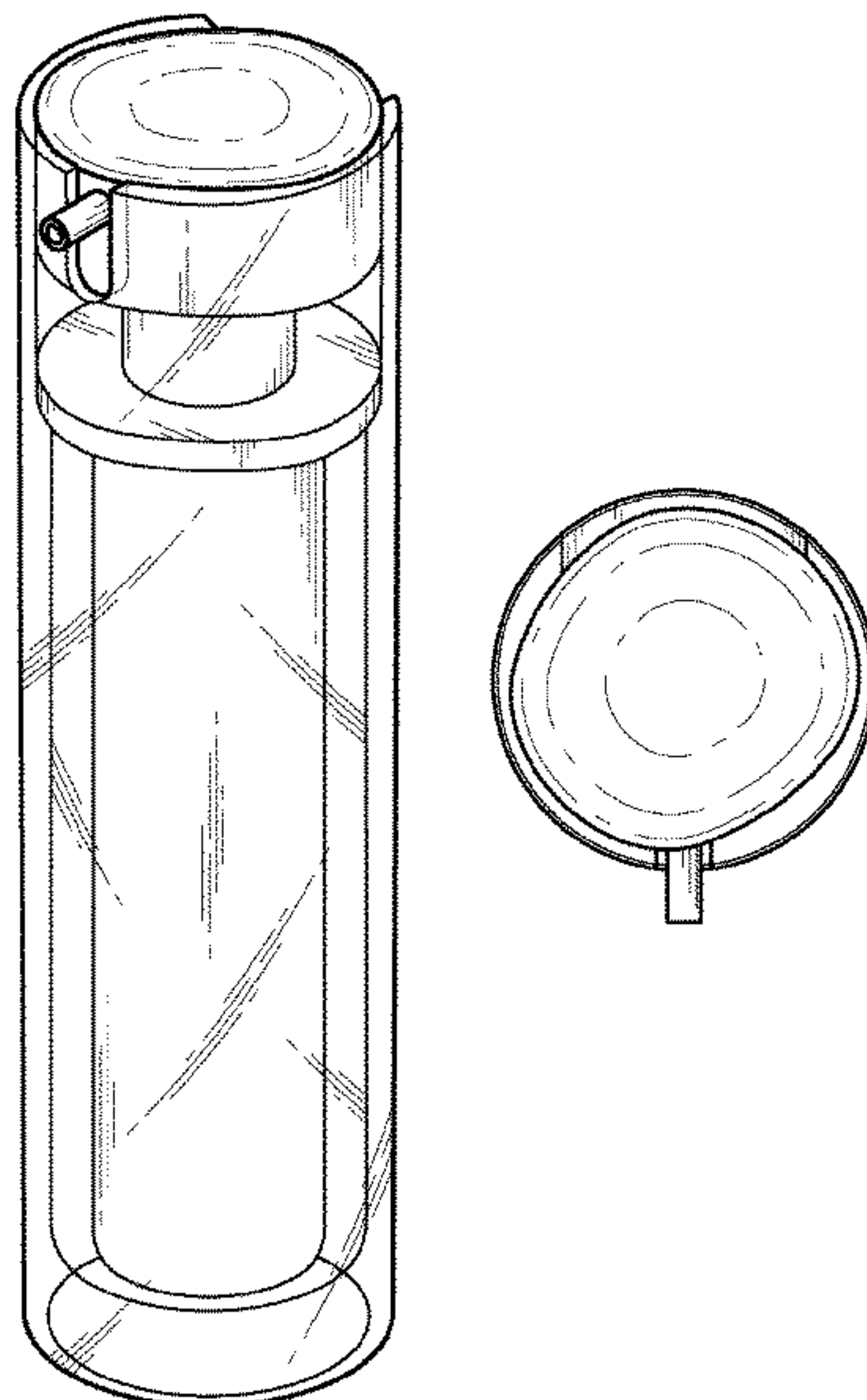

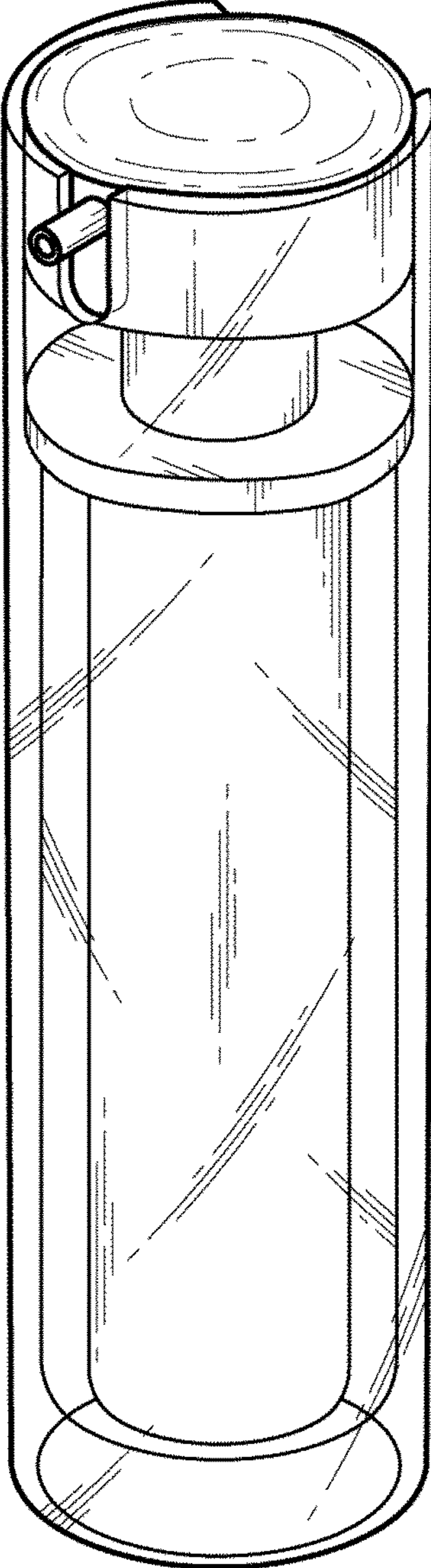

Fig. 1

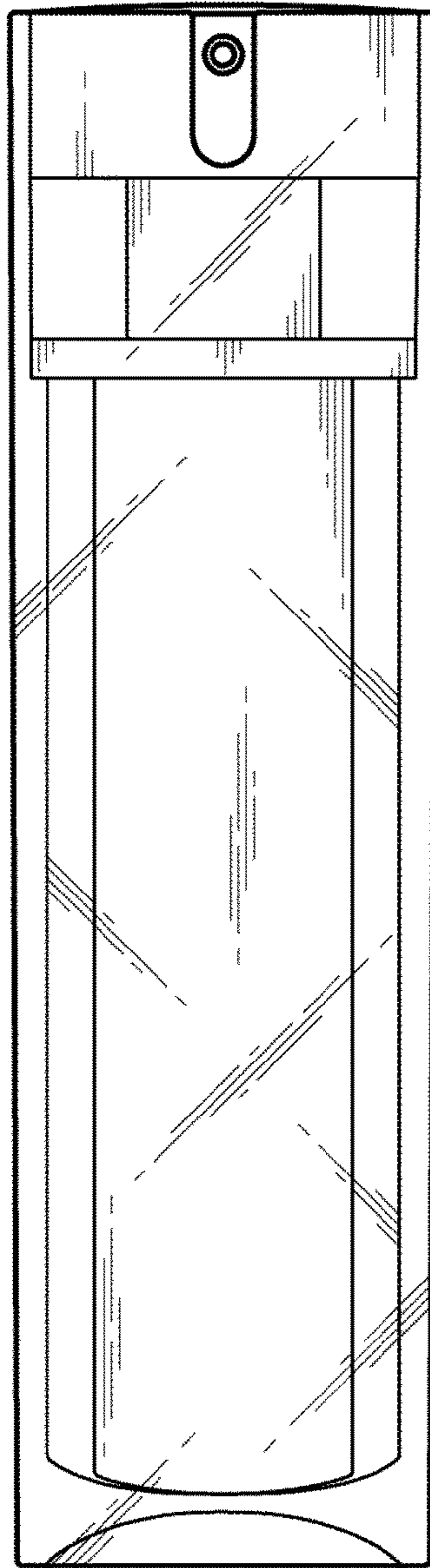

Fig. 2

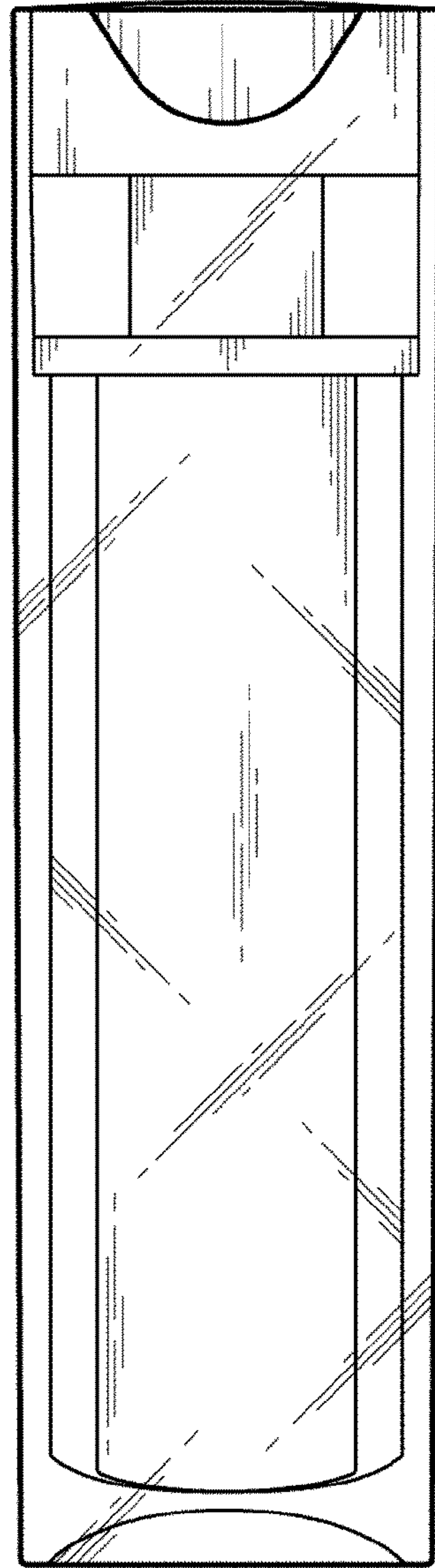

Fig. 3



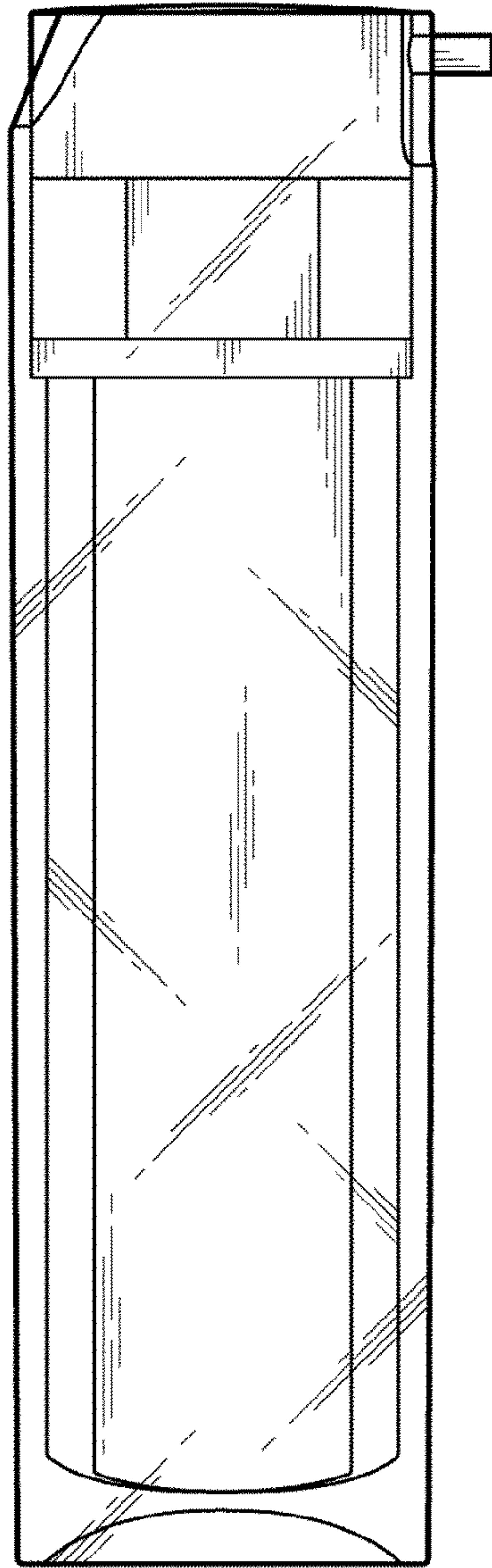

Fig. 4

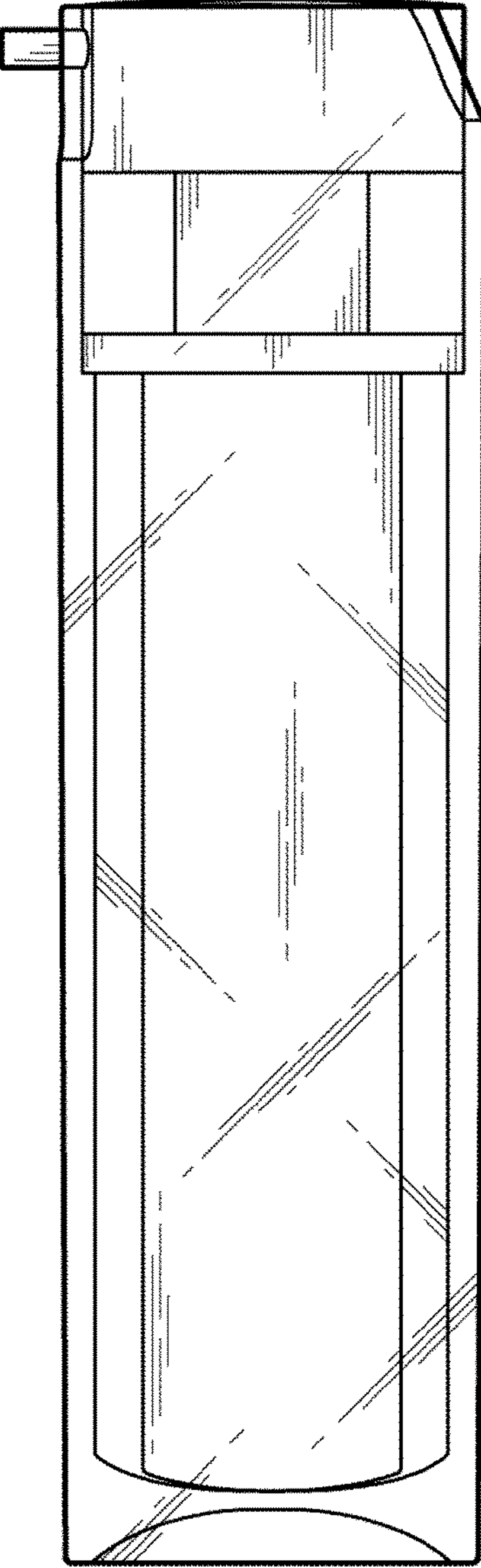

Fig. 5

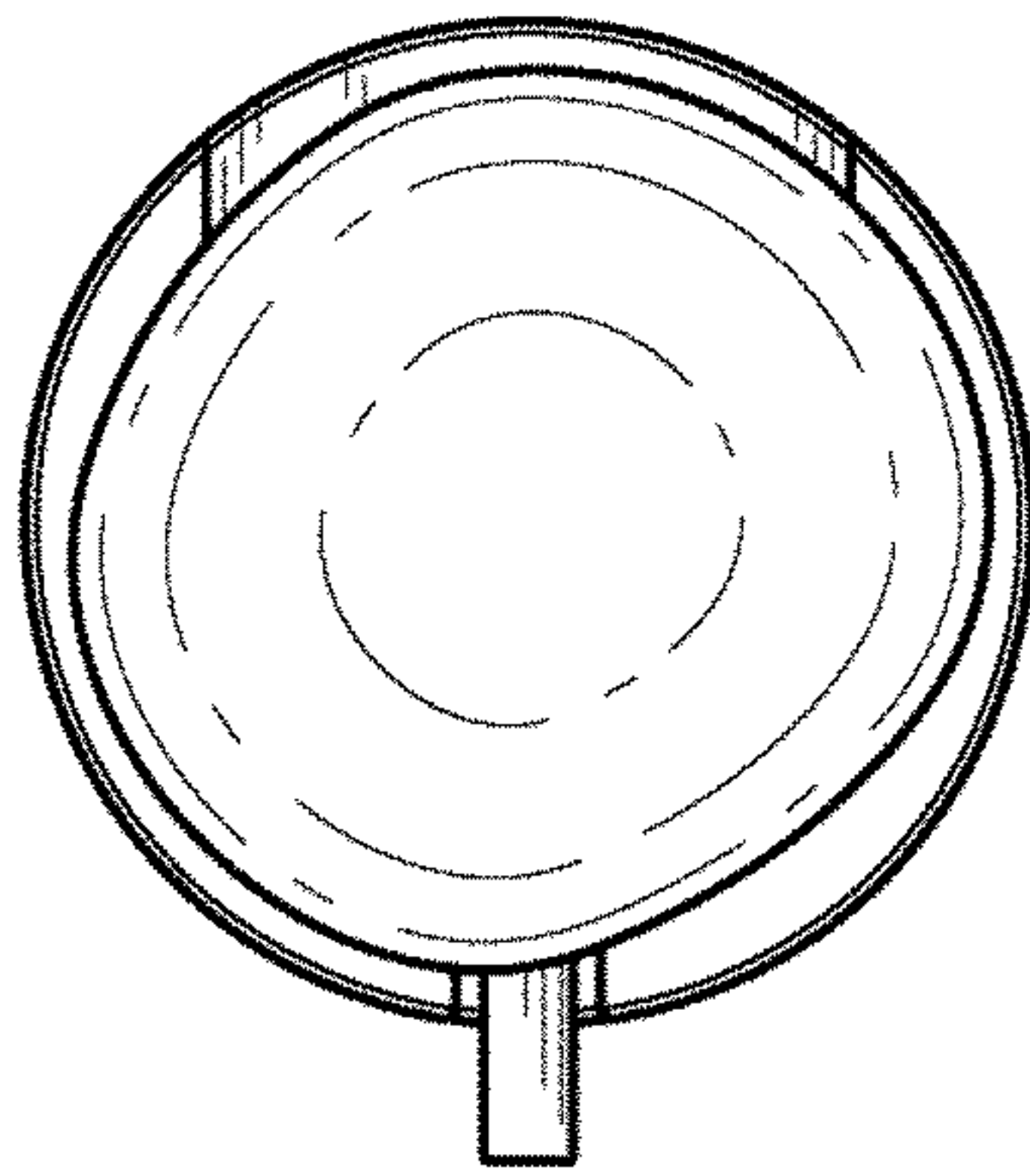

Fig. 6

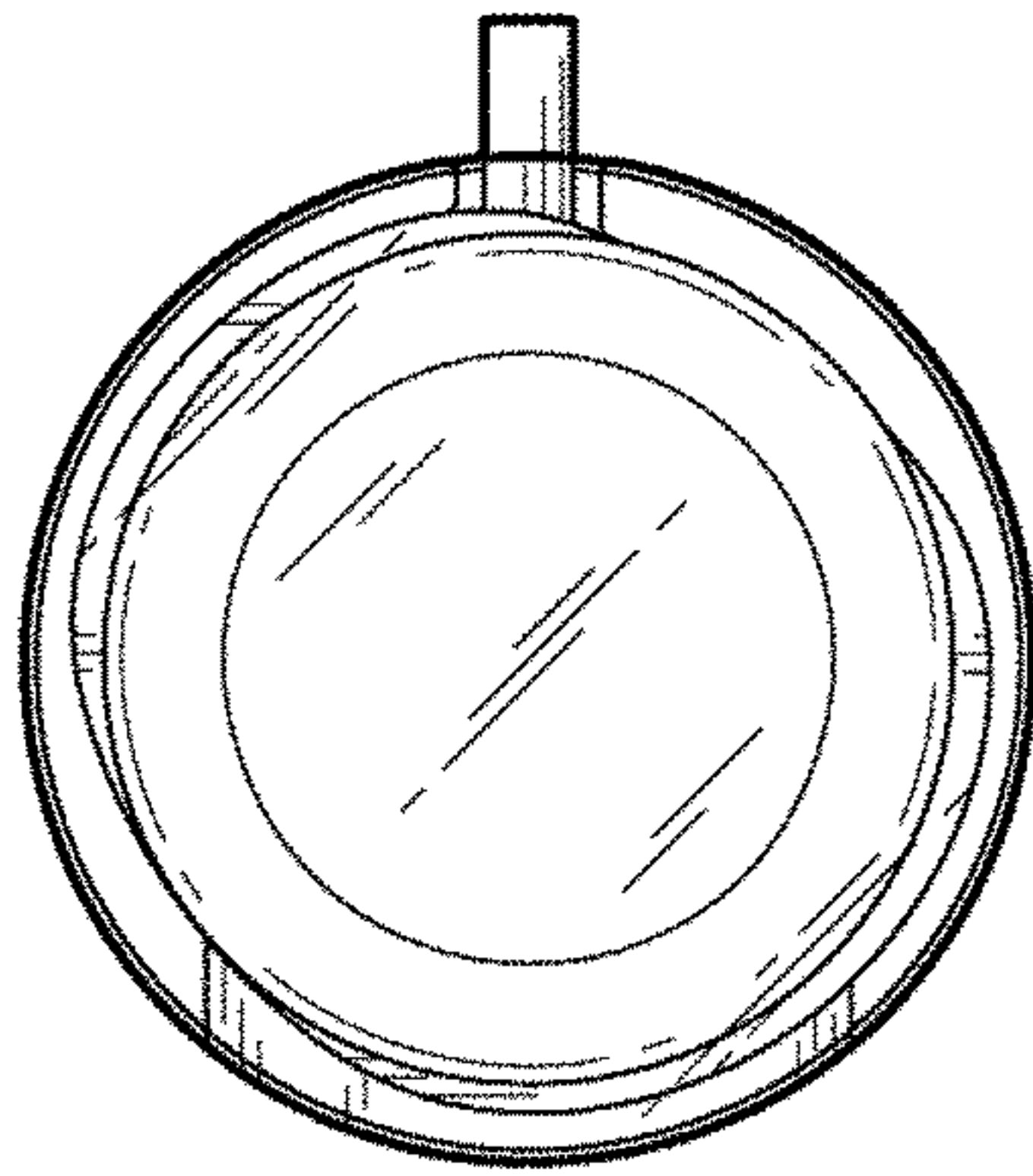

Fig. 7