



US00D714063S

(12) **United States Design Patent**
Ke

(10) **Patent No.:** **US D714,063 S**

(45) **Date of Patent:** **** Sep. 30, 2014**

(54) **LUGGAGE HANDLE WITH TABLET PC SUPPORT**

(71) Applicant: **Shanghai Damao Luggage Co., Ltd.**,
Shanghai (CN)

(72) Inventor: **Huizi Ke**, Shanghai (CN)

(73) Assignee: **Shanghai Damao Luggage Co., Ltd.**,
Shanghai (CN)

(**) Term: **14 Years**

(21) Appl. No.: **29/471,921**

(22) Filed: **Nov. 6, 2013**

(51) **LOC (10) Cl.** **03-01**

(52) **U.S. Cl.**
USPC **D3/318**

(58) **Field of Classification Search**
CPC A45C 13/262; A45C 2013/267; A45C
2013/265; A45C 13/26; A45C 13/22; A45C
13/28

USPC D3/318, 319, 273, 276, 279, 282-287,
D3/289, 290, 321, 902; D8/302, 306, 316,
D8/317; 190/18 A, 100, 103, 104,
190/107-117, 119, 125; 16/18 R, 113.1,
16/114.1, 45

See application file for complete search history.

(56) **References Cited**

U.S. PATENT DOCUMENTS

3,115,228 A * 12/1963 Louik et al. 16/409
3,562,849 A * 2/1971 Brayshaw 16/445

D351,702 S * 10/1994 Breen D34/10
5,762,169 A * 6/1998 Deliman et al. 190/101
D422,450 S * 4/2000 Conti D7/394
6,397,436 B1 * 6/2002 Wang 16/445
D460,265 S * 7/2002 Chang D3/318
D528,302 S * 9/2006 Moon D3/318
D553,364 S * 10/2007 Moon D3/318
D572,905 S * 7/2008 Wu D3/318
D583,153 S * 12/2008 Wu D3/318
D591,511 S * 5/2009 Wu D3/318
D607,641 S * 1/2010 Chen D3/318
D637,398 S * 5/2011 Jiang D3/318
D677,896 S * 3/2013 Wu D3/318
2008/0196988 A1 * 8/2008 Tong 190/102
2010/0187062 A1 * 7/2010 Sweeney et al. 190/1

* cited by examiner

Primary Examiner — Deanna L Pratt

Assistant Examiner — Lilyana Bekic

(74) *Attorney, Agent, or Firm* — Brown & Michaels, PC

(57) **CLAIM**

The ornamental design for a luggage handle with tablet PC support, as shown and described.

DESCRIPTION

FIG. 1 is a perspective view of the luggage handle with tablet PC support.

FIG. 2 is a right side view of the luggage handle.

FIG. 3 is a left side view of the luggage handle, showing the opposite side from FIG. 2.

FIG. 4 is a top view of the luggage handle.

FIG. 5 is a bottom view of the luggage handle.

FIG. 6 is a front view of the luggage handle; and,

FIG. 7 is a back view of the luggage handle.

1 Claim, 2 Drawing Sheets

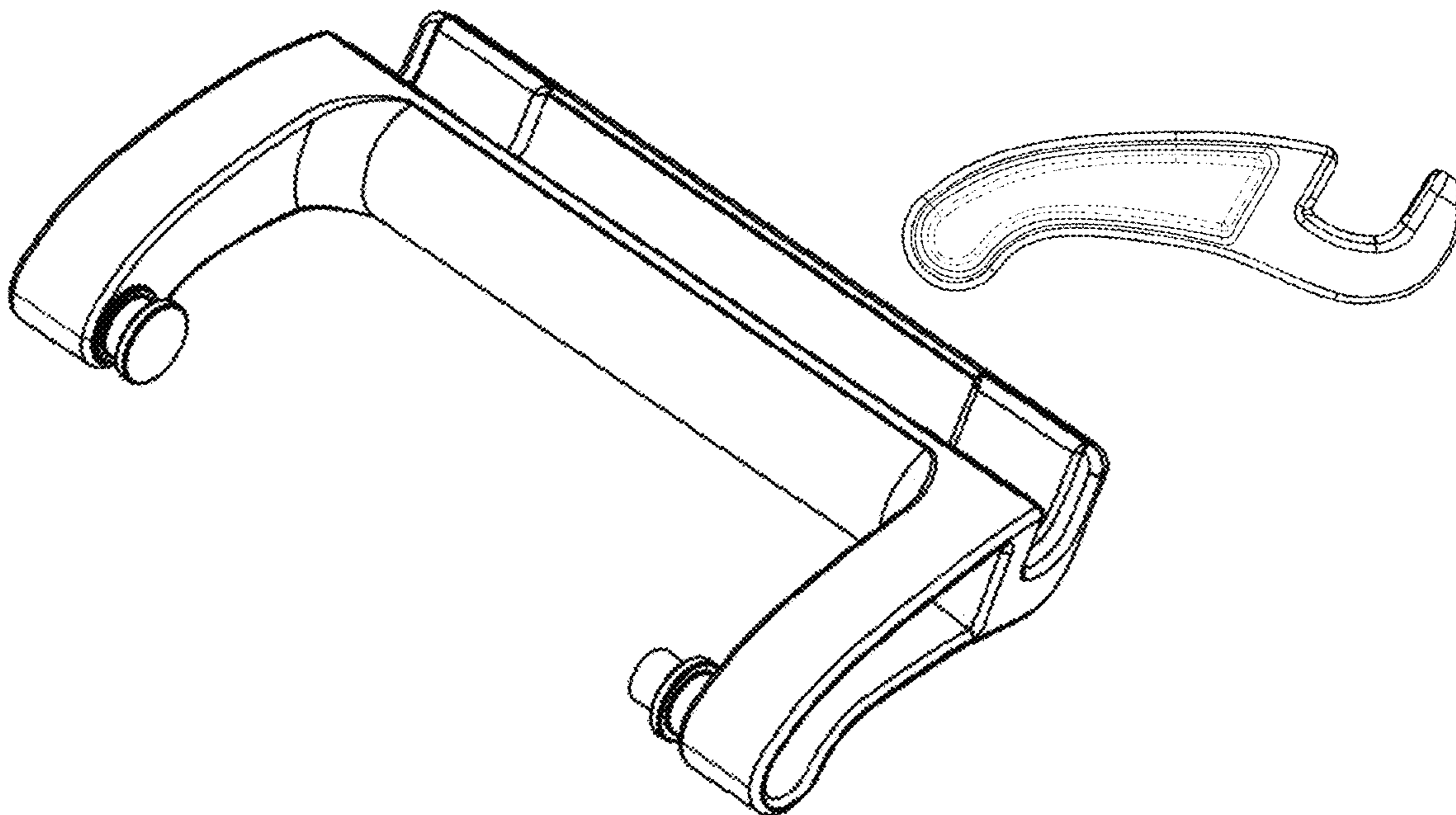

Fig.1

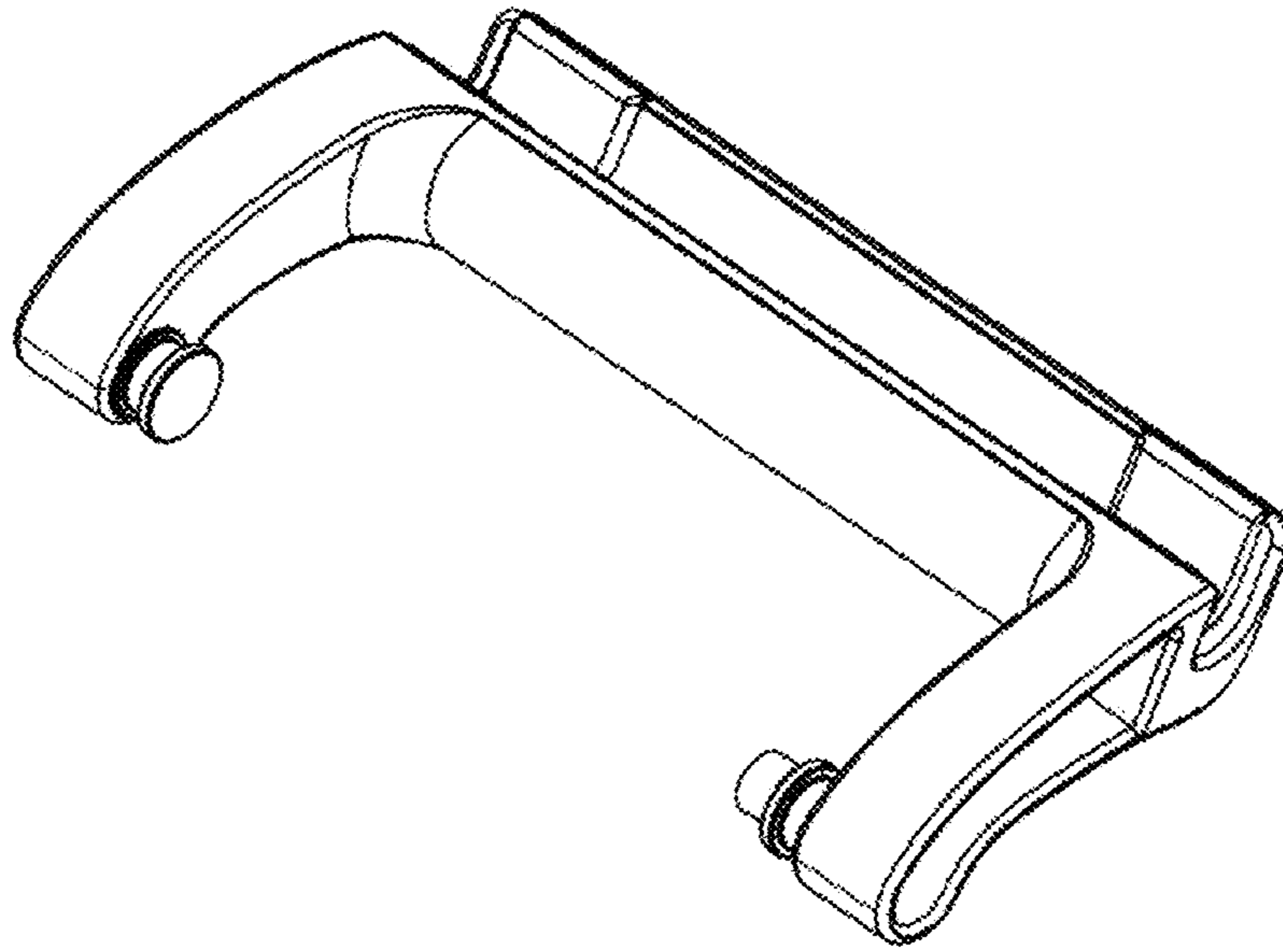

Fig.2

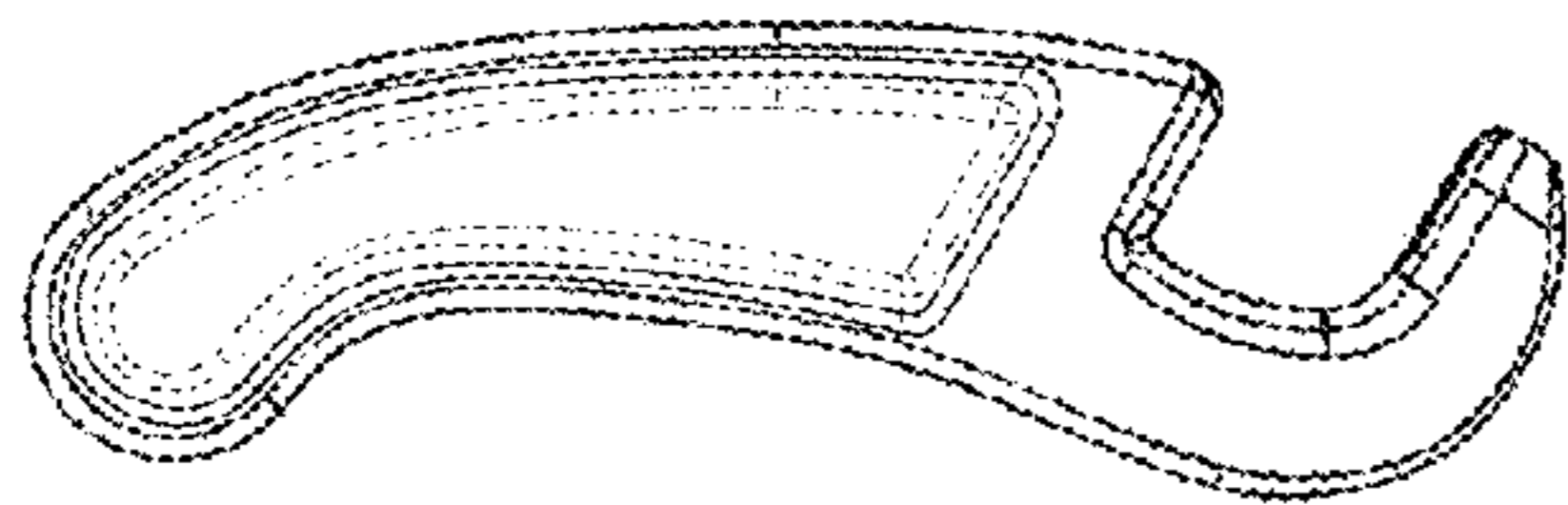

Fig.3

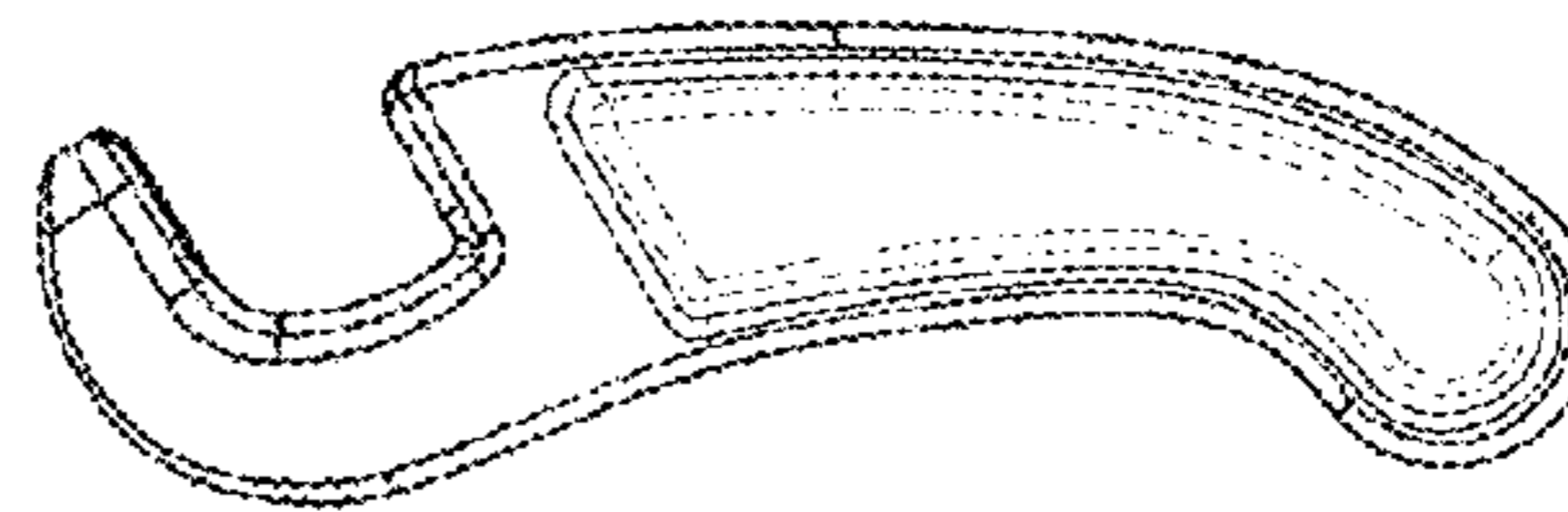

Fig.4

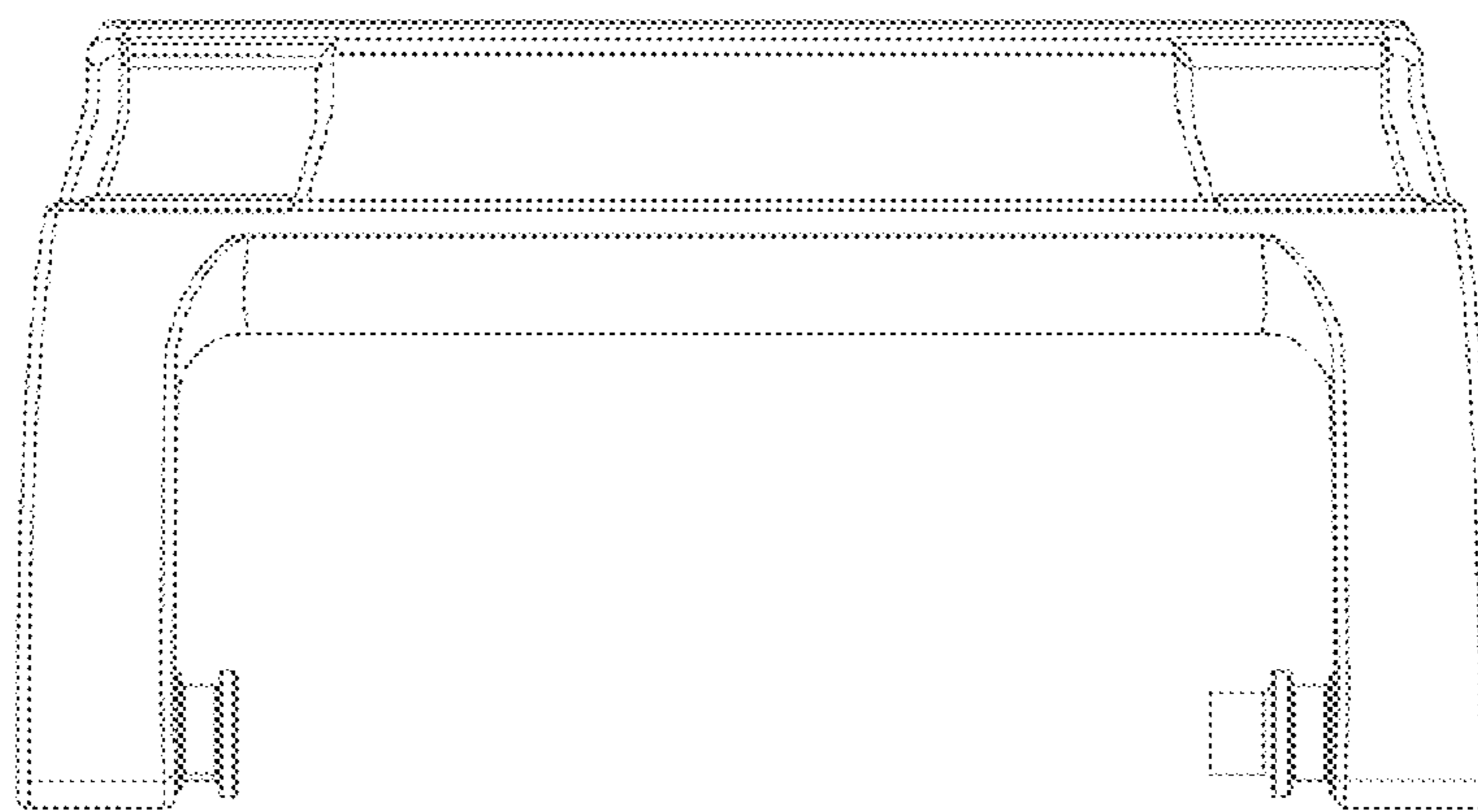

Fig.5

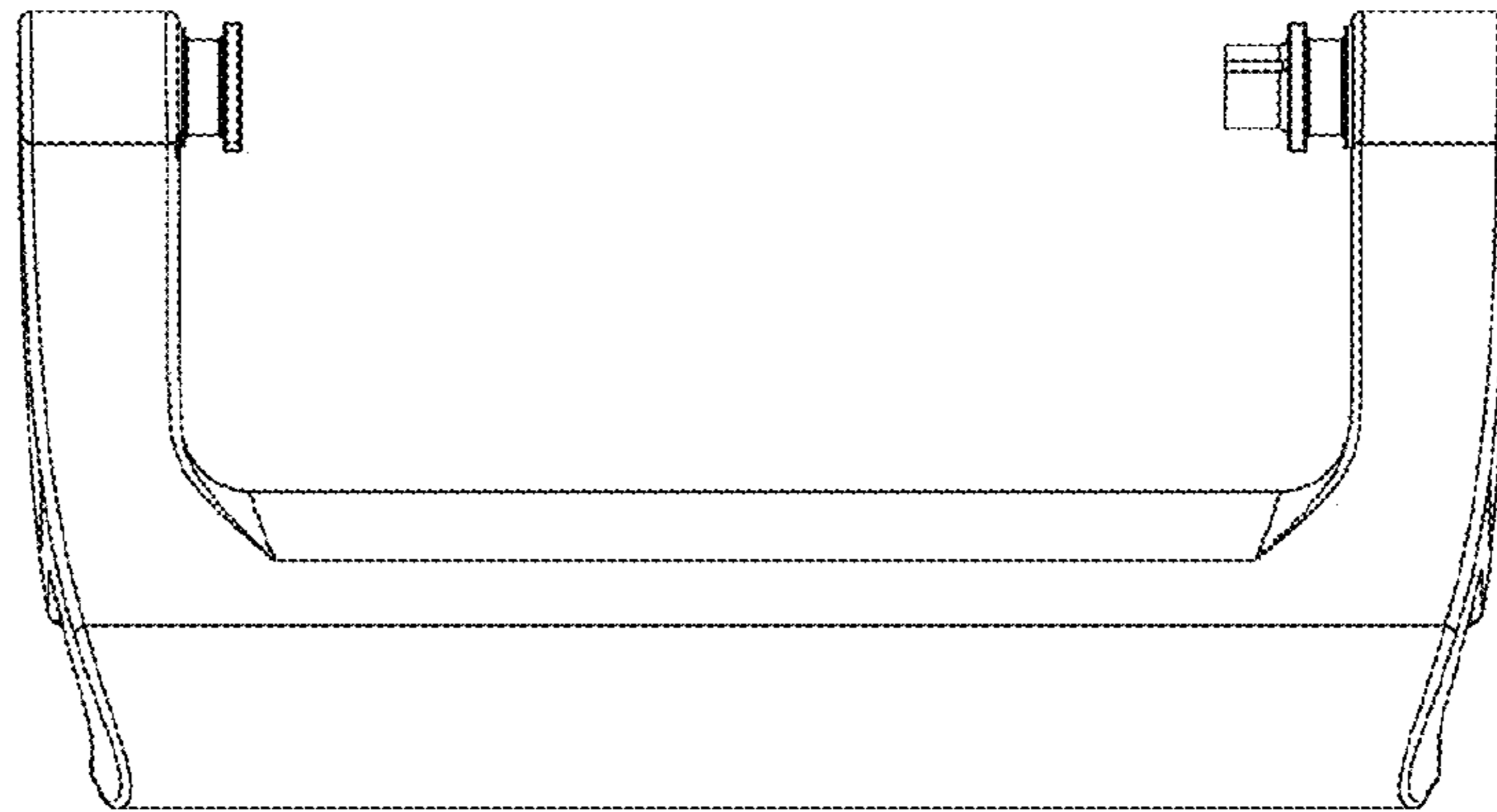

Fig.6

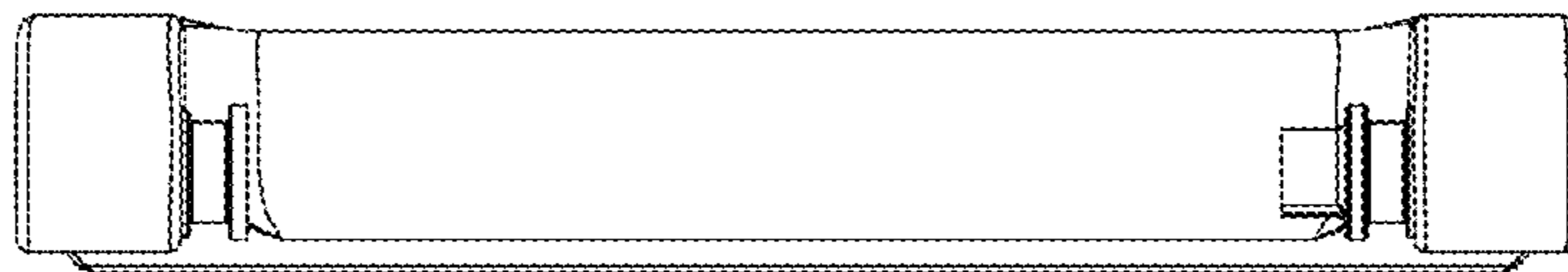

Fig.7

