



US00D713929S

(12) **United States Design Patent**  
**Zajić**

(10) **Patent No.:** **US D713,929 S**

(45) **Date of Patent:** **\*\* Sep. 23, 2014**

(54) **WATER AERATOR**

(71) Applicant: **Toring Turbine d.o.o.**, Koper (SI)

(72) Inventor: **Alfred Zajić**, Koper (SI)

(73) Assignee: **Toring Turbine, d.o.o.**, Koper (SI)

(\*\*) Term: **14 Years**

(21) Appl. No.: **29/456,541**

(22) Filed: **May 31, 2013**

(30) **Foreign Application Priority Data**

Apr. 22, 2013 (EM) ..... 002224550-0001

(51) **LOC (10) Cl.** ..... **23-01**

(52) **U.S. Cl.**  
USPC ..... **D23/207**

(58) **Field of Classification Search**  
CPC ..... B01F 3/04  
USPC ..... D23/207, 213; 210/629, 220, 758;  
261/30; 99/323.1

See application file for complete search history.

(56) **References Cited**

**U.S. PATENT DOCUMENTS**

3,066,921	A *	12/1962	Thommel et al.	.....	261/30
3,796,414	A *	3/1974	Winton	.....	261/29
3,904,393	A *	9/1975	Morse	.....	210/167.23
4,267,052	A *	5/1981	Chang	.....	210/629
4,280,911	A *	7/1981	Durda et al.	.....	210/629
4,732,682	A *	3/1988	Rymal	.....	210/620
5,595,104	A *	1/1997	Delaplaine	.....	99/323.1
7,172,177	B2 *	2/2007	Durda	.....	261/28
8,561,970	B1 *	10/2013	Mills et al.	.....	261/30
8,646,757	B1 *	2/2014	McGrew, Jr.	.....	261/83

\* cited by examiner

*Primary Examiner* — Robin V Webster

(74) *Attorney, Agent, or Firm* — Bryant J. Keller; Kirton McConkie

(57) **CLAIM**

The ornamental design for a water aerator, as shown and described.

**DESCRIPTION**

FIG. 1 is a front, right side perspective view showing a representative embodiment of my new design comprising an attachment, wherein the front, left side perspective view is a mirror image thereof;

FIG. 2 is a front elevation view of a representative embodiment thereof;

FIG. 3 is a back elevation view of a representative embodiment thereof;

FIG. 4 is a left side elevation view of a representative embodiment thereof;

FIG. 5 is a right side elevation view of a representative embodiment thereof;

FIG. 6 is a top side elevation view of a representative embodiment thereof;

FIG. 7 is a bottom side elevation view of a representative embodiment thereof;

FIG. 8 is a front, right side perspective view showing the representative embodiment of FIG. 1 without the attachment, wherein the front, left side perspective view is a mirror image thereof;

FIG. 9 is a front elevation view of a representative embodiment thereof;

FIG. 10 is a back elevation view of a representative embodiment thereof;

FIG. 11 is a left side elevation view of a representative embodiment thereof;

FIG. 12 is a right side elevation view of a representative embodiment thereof;

FIG. 13 is a top side elevation view of a representative embodiment thereof; and,

FIG. 14 is a bottom side elevation view of a representative embodiment thereof.

**1 Claim, 8 Drawing Sheets**

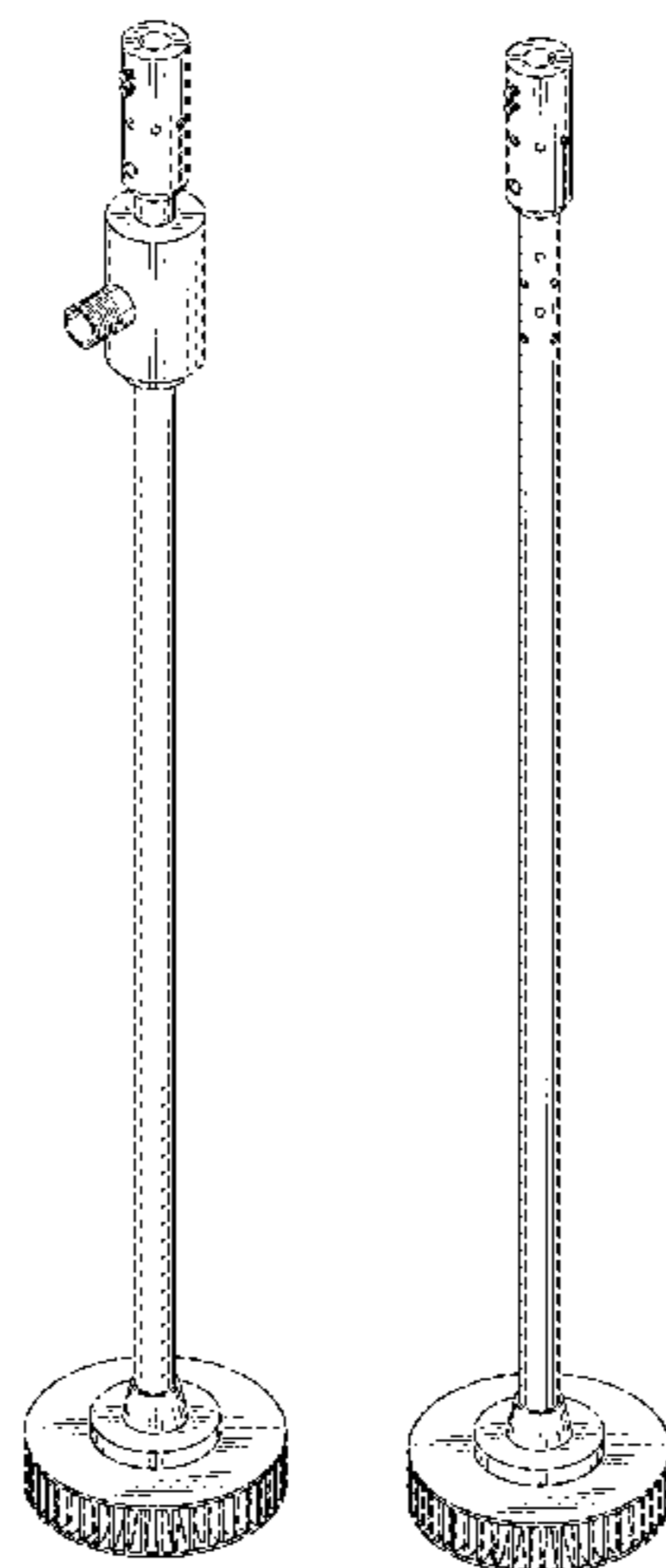

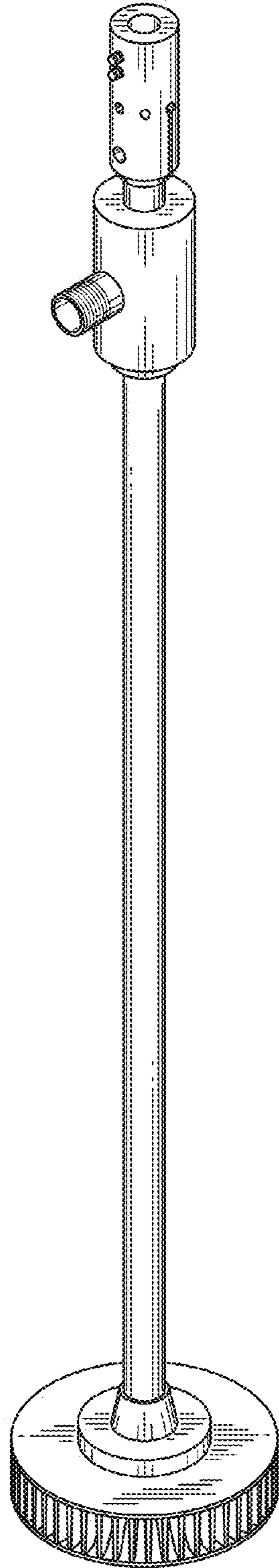

FIG. 1

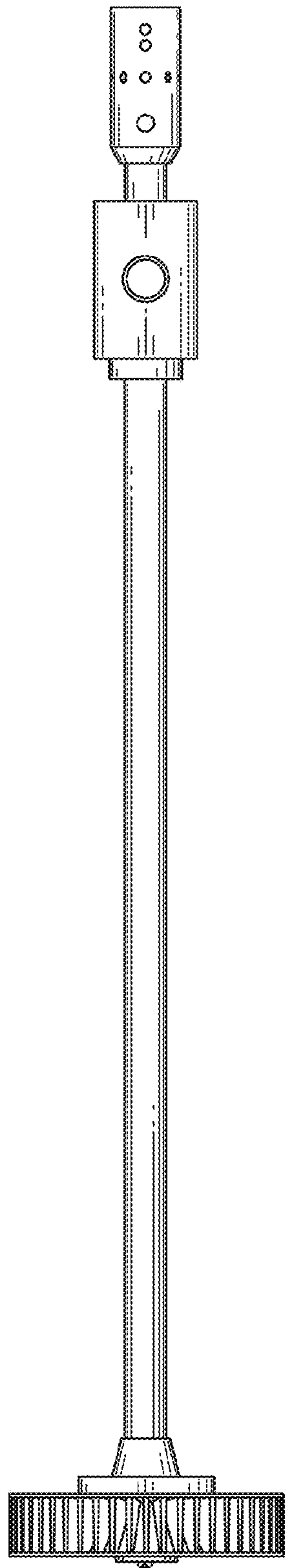

FIG. 2

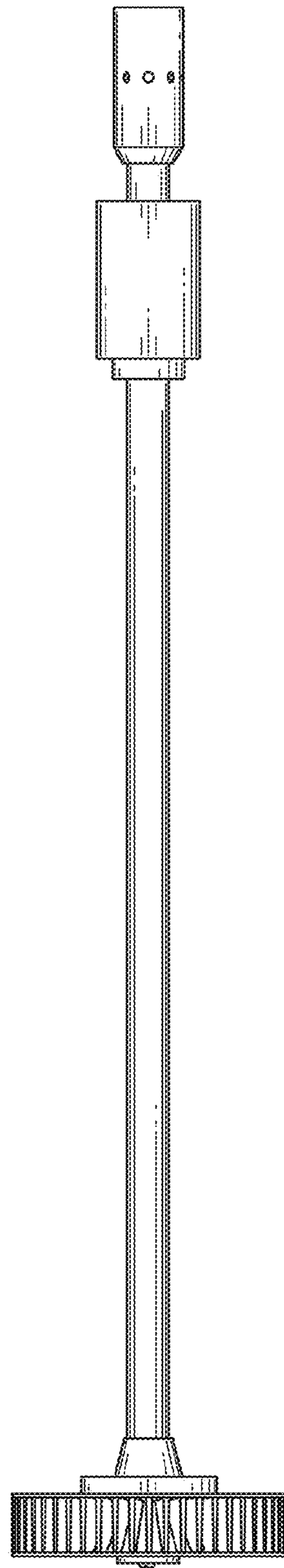

FIG. 3

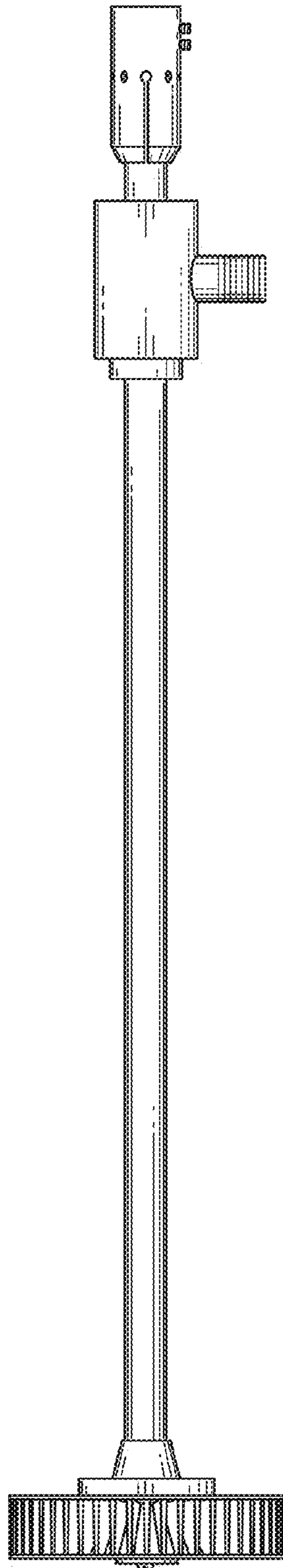

FIG. 4

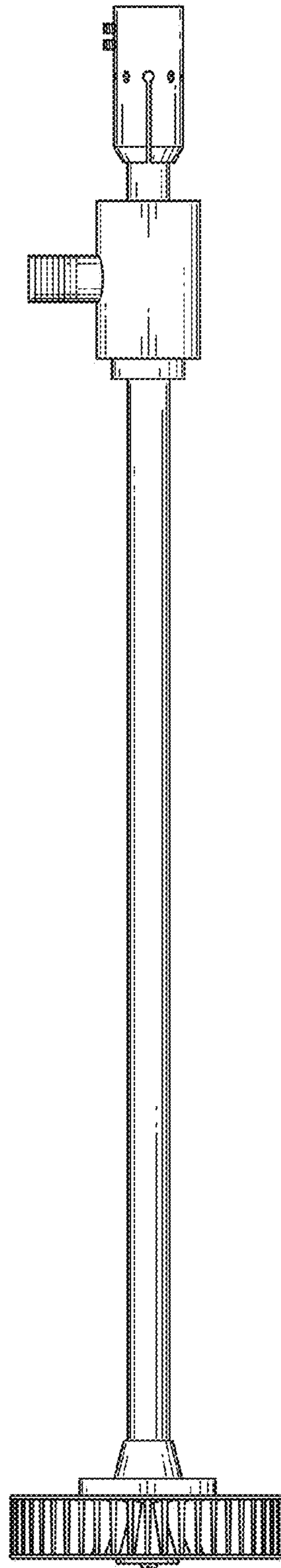

FIG. 5

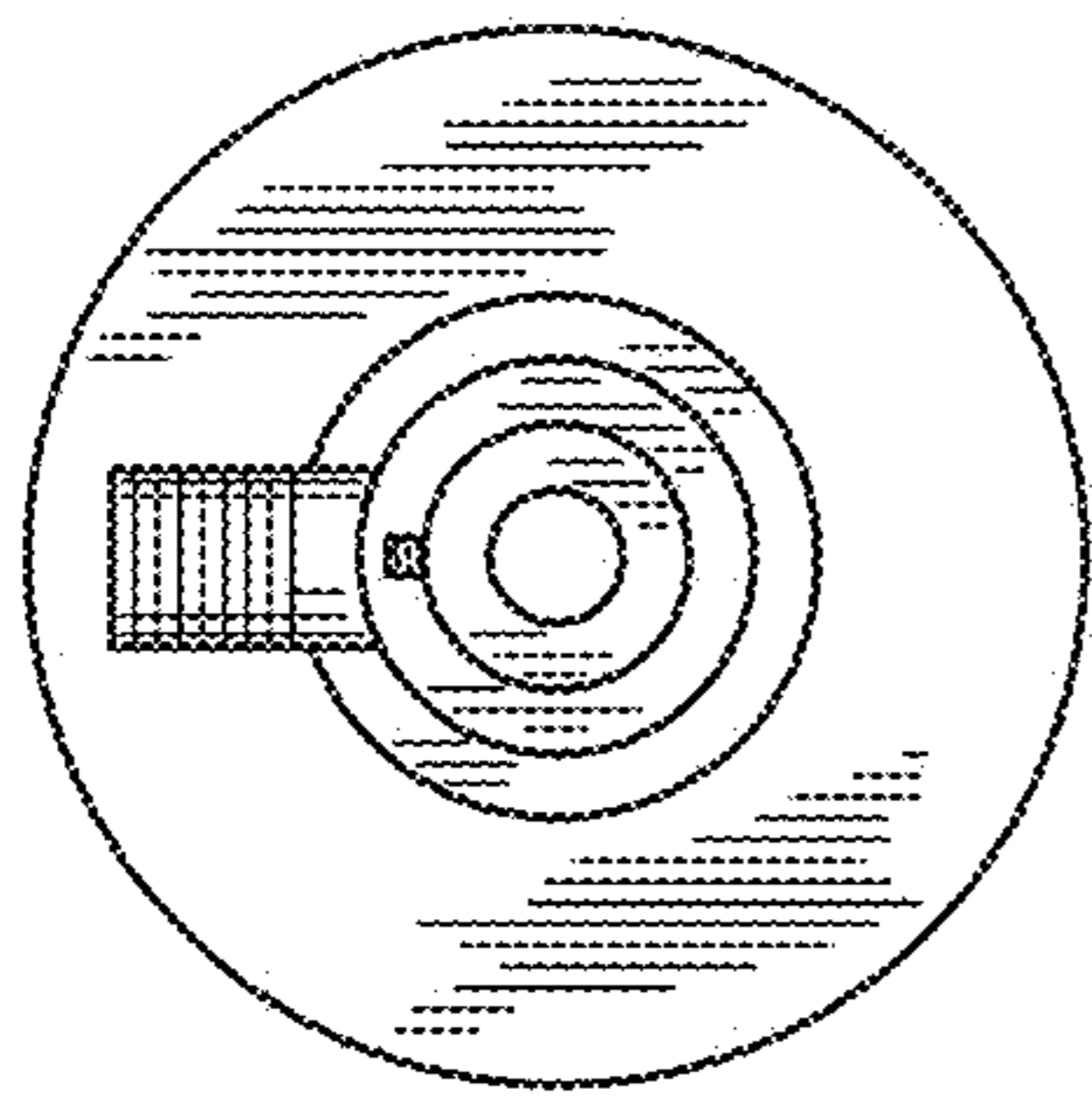

FIG. 6

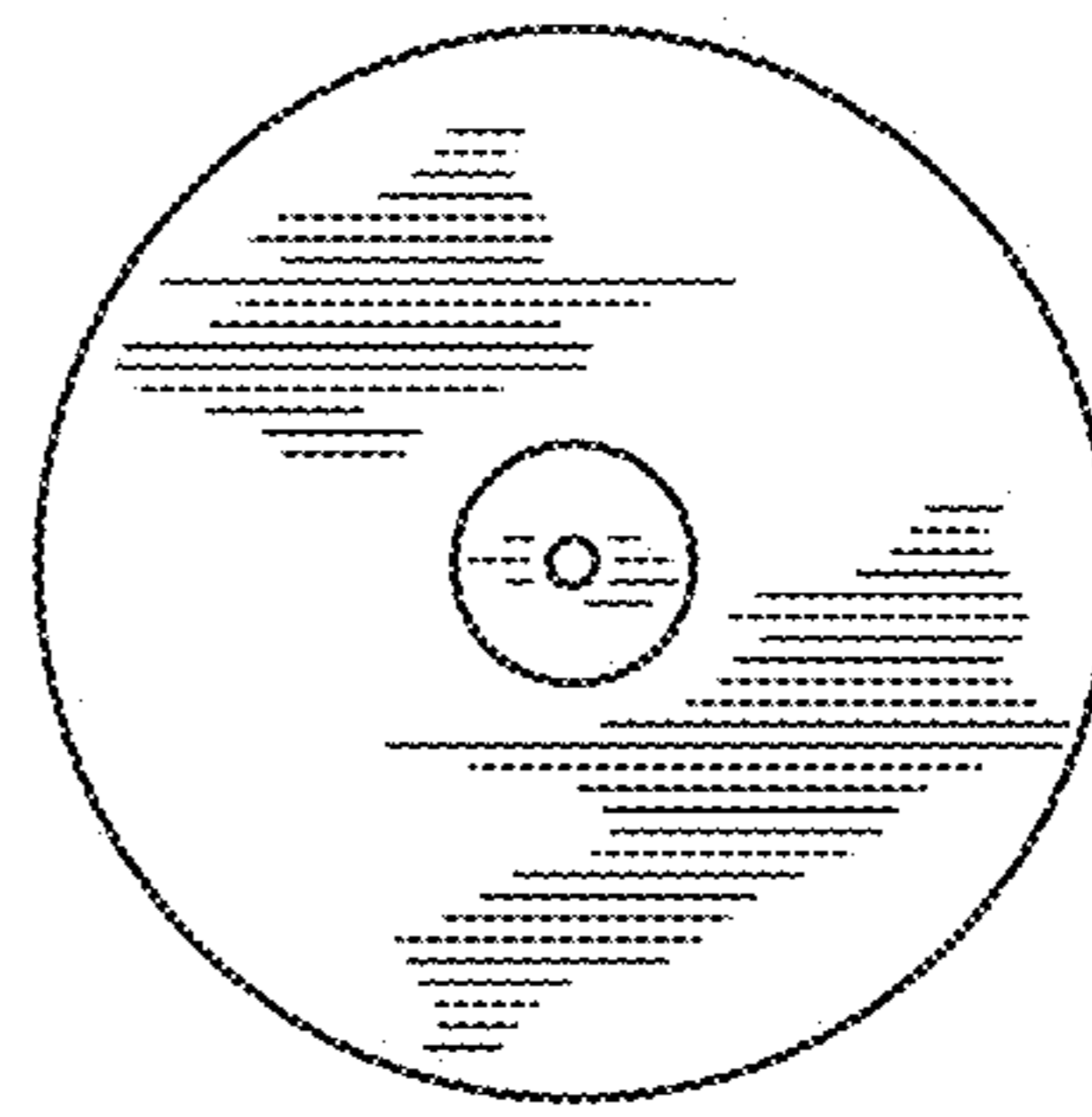

FIG. 7

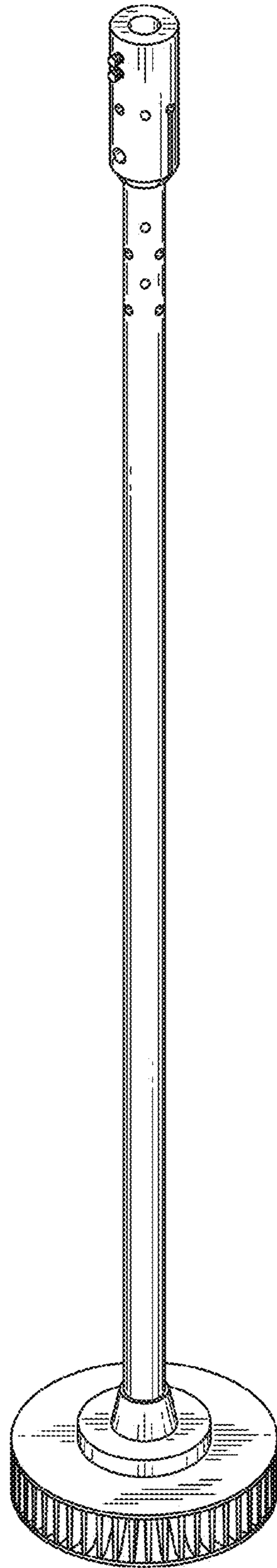

FIG. 8

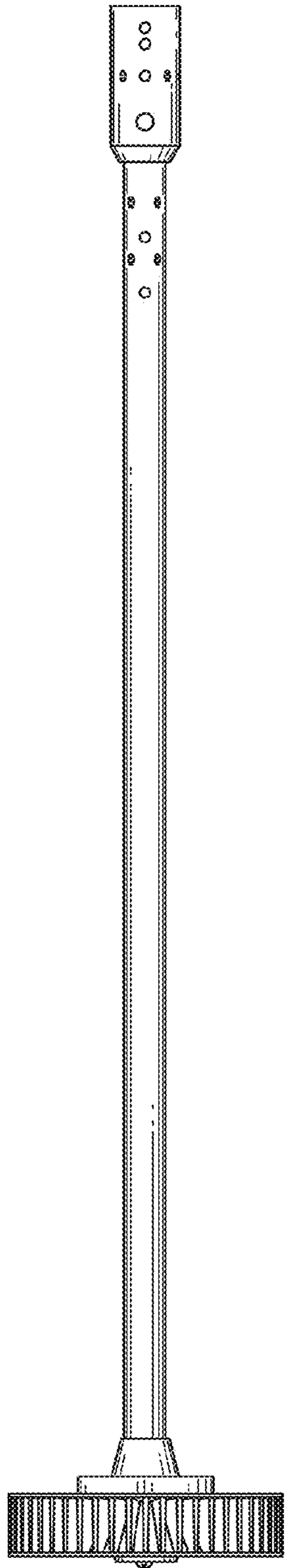

FIG. 9

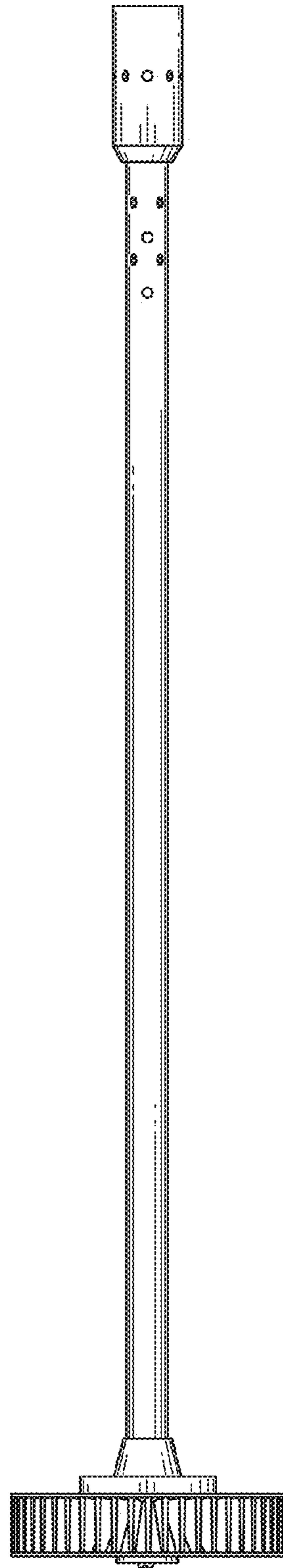

FIG. 10

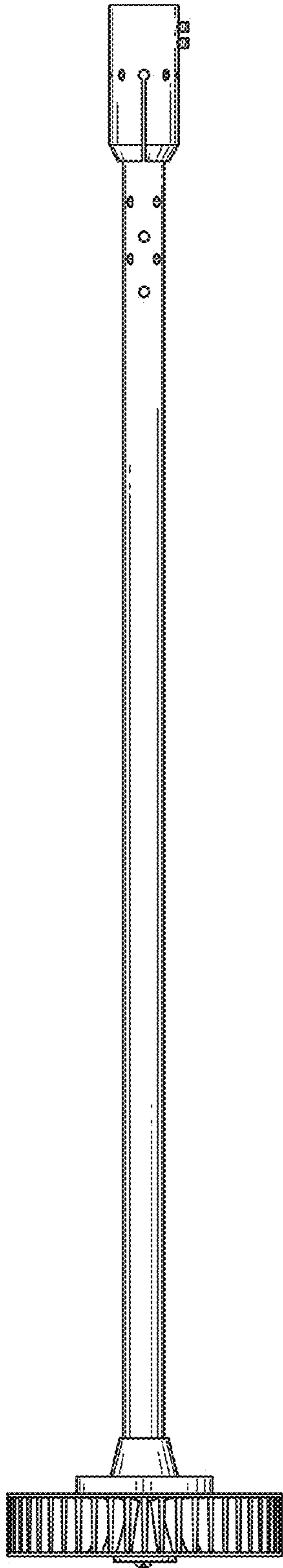

FIG. 11

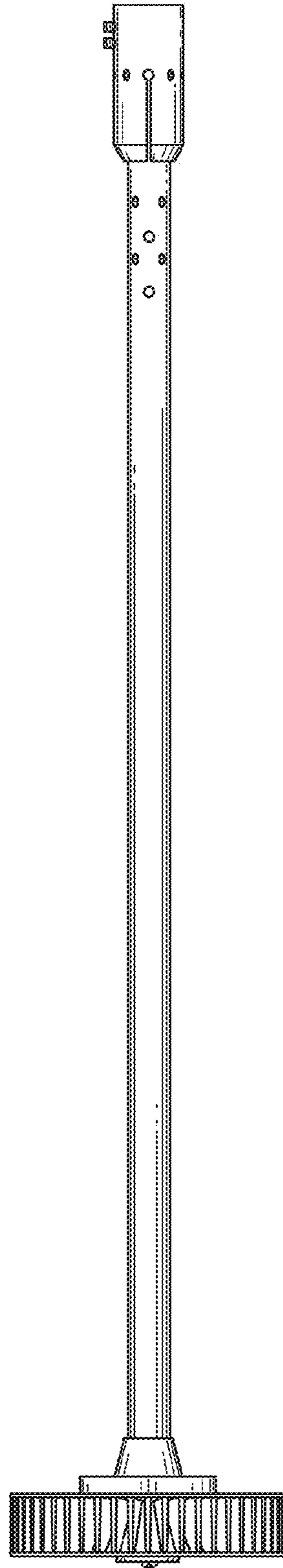

FIG. 12



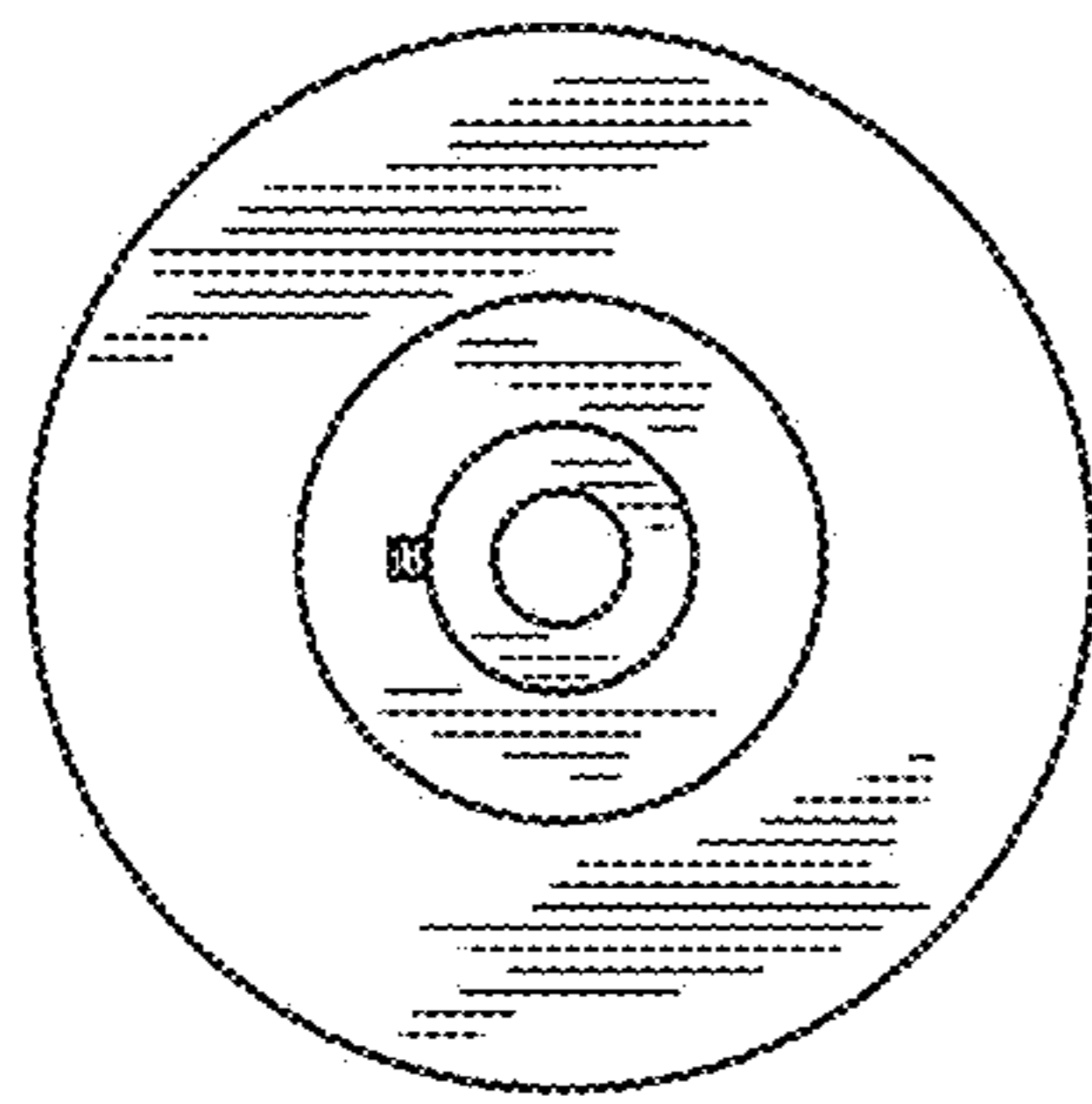

FIG. 13

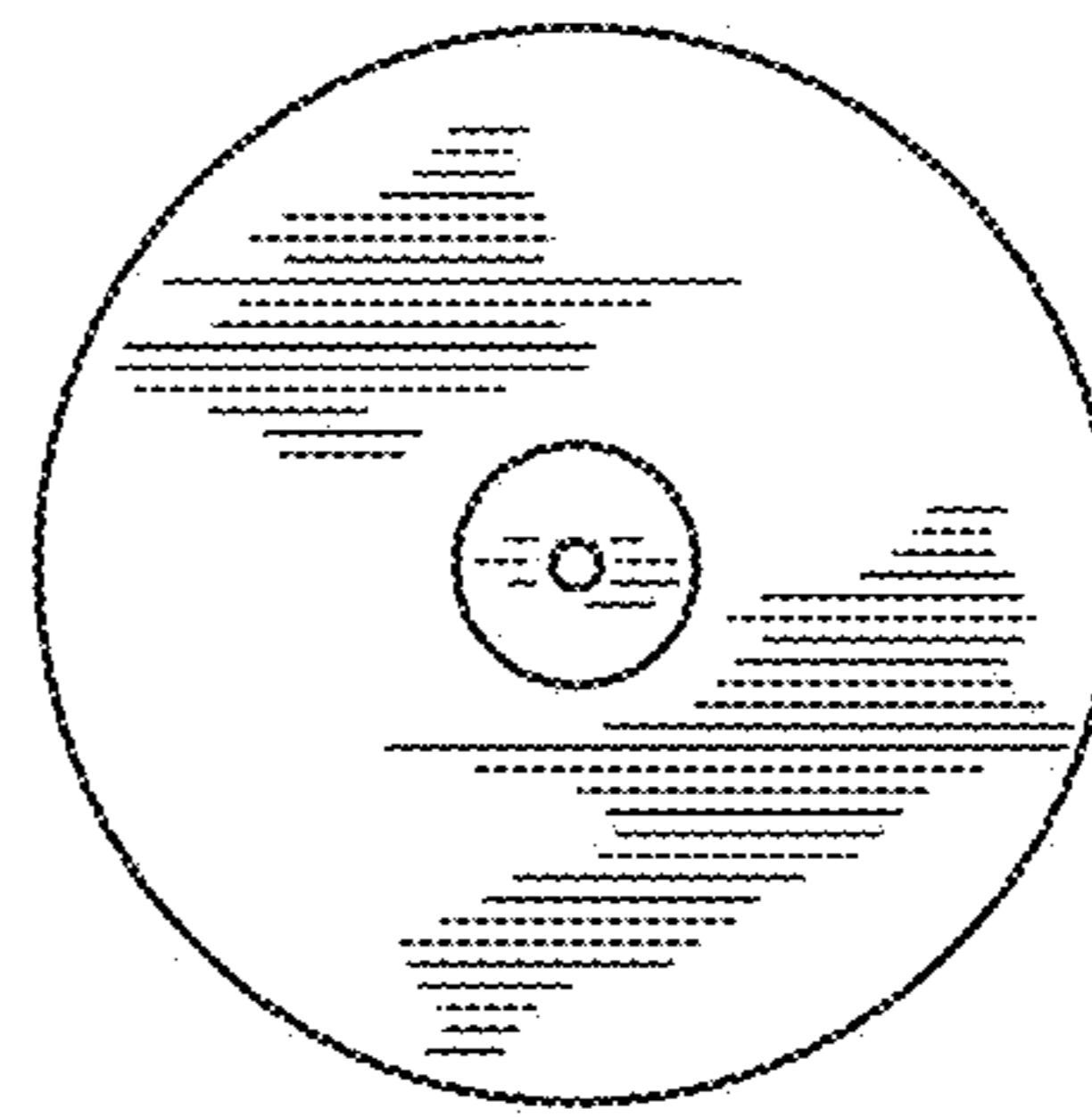

FIG. 14