



US00D713879S

(12) **United States Design Patent**  
**Shibata**

(10) **Patent No.:** **US D713,879 S**

(45) **Date of Patent:** **\*\* Sep. 23, 2014**

(54) **BALLPOINT PEN**

(71) Applicant: **Pentel Kabushiki Kaisha**, Tokyo (JP)

(72) Inventor: **Tomoaki Shibata**, Tokyo (JP)

(73) Assignee: **Pentel Kabushiki Kaisha** (JP)

(\*\*) Term: **14 Years**

(21) Appl. No.: **29/453,482**

(22) Filed: **Apr. 30, 2013**

(30) **Foreign Application Priority Data**

Nov. 6, 2012 (JP) ..... 2012-026991

(51) **LOC (10) Cl.** ..... **19-06**

(52) **U.S. Cl.**  
USPC ..... **D19/168**

(58) **Field of Classification Search**  
USPC ..... D14/411; D19/115-186, 194, 912, 914,  
D19/923; 24/11 R, 11 F, 11 P; 401/52, 99,  
401/109, 192, 195, 196  
See application file for complete search history.

(56) **References Cited**

**U.S. PATENT DOCUMENTS**

D162,805 S *	4/1951	Ferber	.....	D19/48
D358,844 S *	5/1995	Ito	.....	D19/57
D454,590 S *	3/2002	Sakuno	.....	D19/57
D484,538 S *	12/2003	Daida et al.	.....	D19/43
D490,107 S *	5/2004	Wong	.....	D19/50
D490,108 S *	5/2004	Moon	.....	D19/50
D499,139 S *	11/2004	Oka	.....	D19/47
D502,503 S *	3/2005	Kimura	.....	D19/36
D553,191 S *	10/2007	Qiu	.....	D19/50
D562,387 S *	2/2008	Qiu et al.	.....	D19/44
D562,895 S *	2/2008	Shibata	.....	D19/50
D569,431 S *	5/2008	Qiu et al.	.....	D19/51
D575,820 S *	8/2008	Hamilton et al.	.....	D19/50
D576,677 S *	9/2008	Jeon	.....	D19/50

D594,059 S *	6/2009	Shibata	.....	D19/48
D608,392 S *	1/2010	Shibata	.....	D19/50
D609,744 S *	2/2010	Rathod	.....	D19/48
D611,535 S *	3/2010	Shimizu	.....	D19/48
D641,783 S *	7/2011	Lira-Nunez et al.	.....	D19/48
D642,620 S *	8/2011	Allemeier	.....	D19/50
D648,790 S *	11/2011	Nakazawa	.....	D19/50
D659,760 S *	5/2012	Zhang	.....	D19/51
D667,881 S *	9/2012	Li	.....	D19/48
D690,359 S *	9/2013	Mao	.....	D19/170
D695,828 S *	12/2013	Kim	.....	D19/933

**FOREIGN PATENT DOCUMENTS**

EM	0007521420001	4/2007
JP	1244023	6/2005

**OTHER PUBLICATIONS**

Russian Office Action mailed Oct. 29, 2013 issued in Russian Appln. No. 2013501588.

\* cited by examiner

*Primary Examiner* — Elizabeth Albert

(74) *Attorney, Agent, or Firm* — Adams & Wilks

(57) **CLAIM**

The ornamental design for a ballpoint pen, as shown and described.

**DESCRIPTION**

FIG. 1 is a perspective view of the front, top and left side view of a ballpoint pen showing my new design;  
FIG. 2 is a front view thereof;  
FIG. 3 is a rear view thereof;  
FIG. 4 is a bottom view thereof, a top view being a mirror image thereof;  
FIG. 5 is a left side view thereof;  
FIG. 6 is a right side view thereof;  
FIG. 7 is a front view without cap thereof; and,  
FIG. 8 is a bottom view without cap thereof.

**1 Claim, 4 Drawing Sheets**

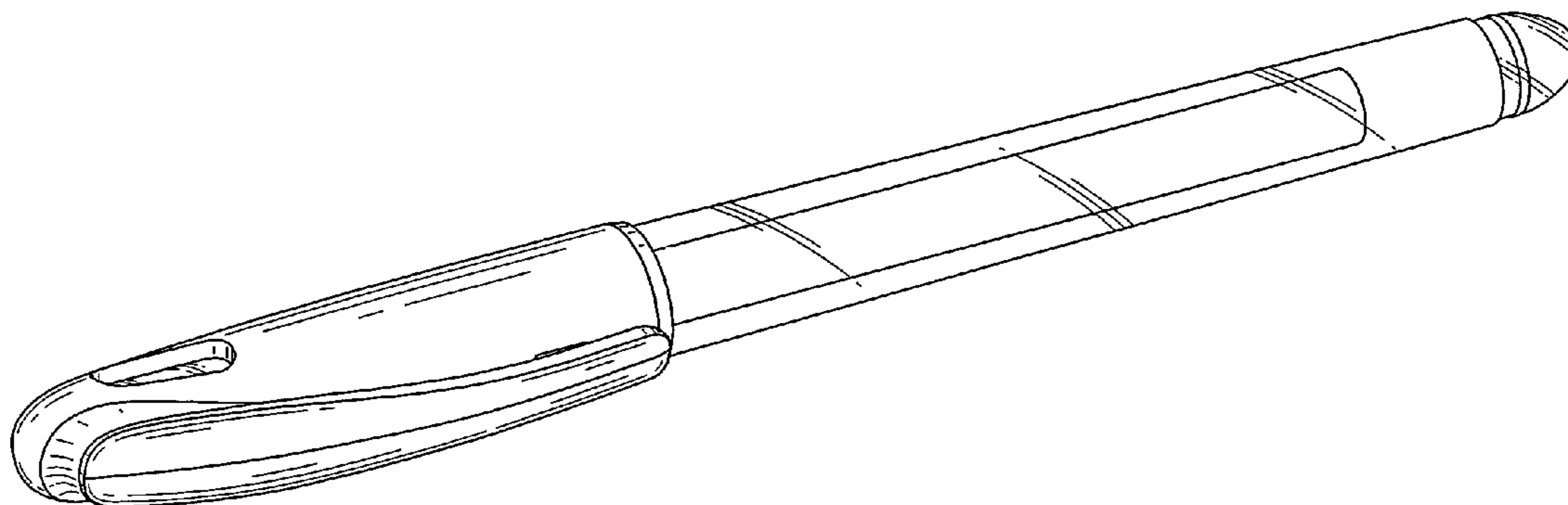

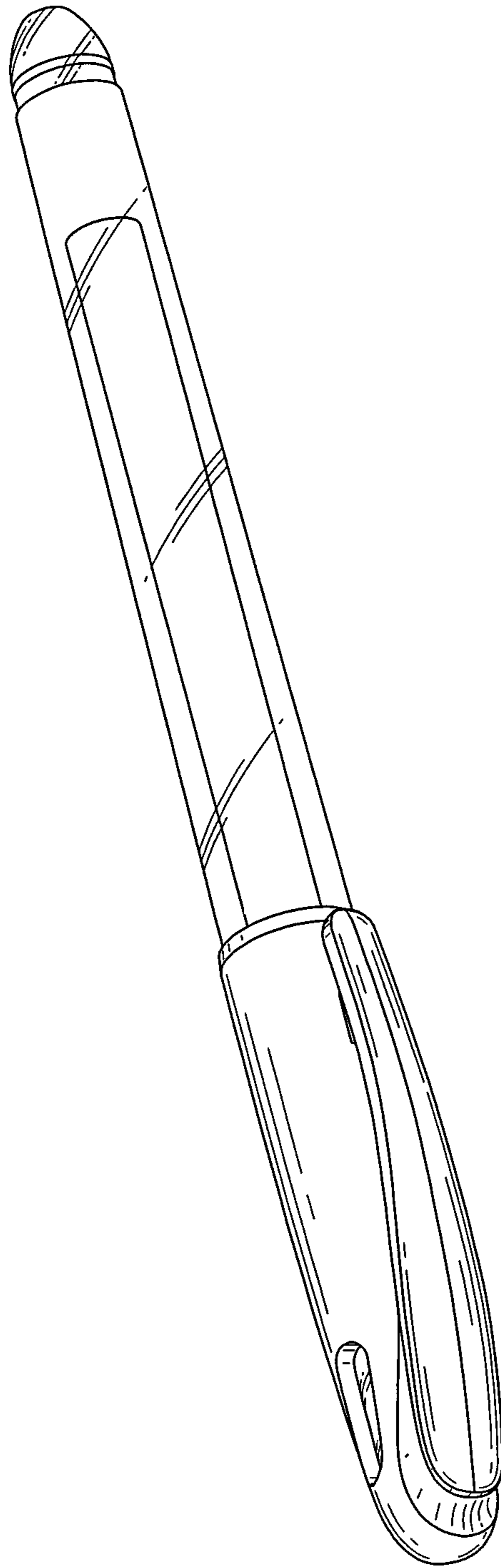

FIG. 1

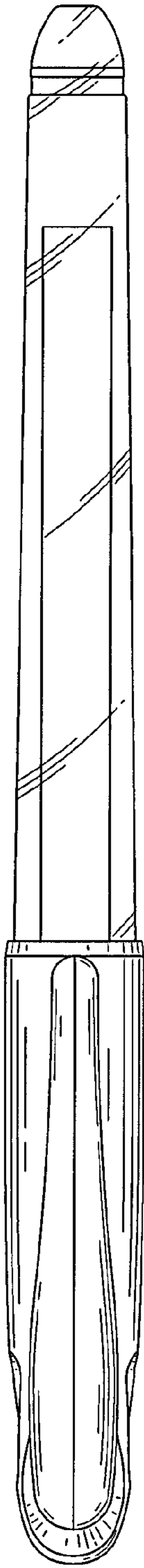

FIG. 2

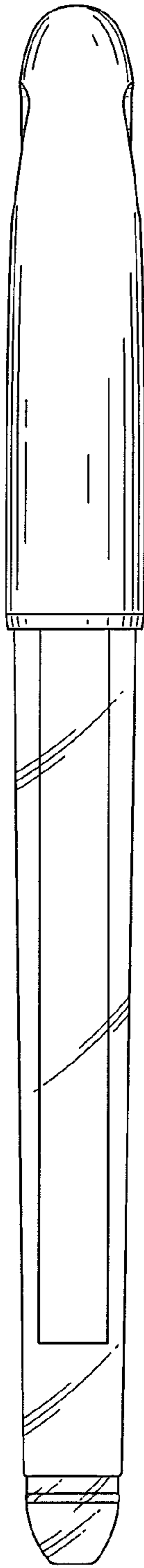

FIG. 3

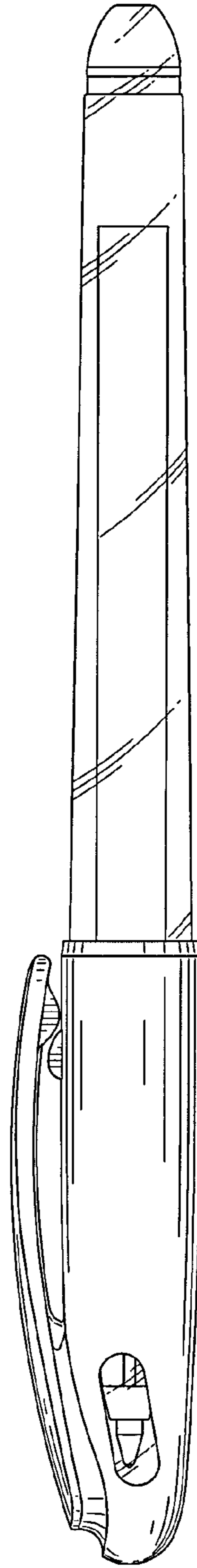

FIG. 4

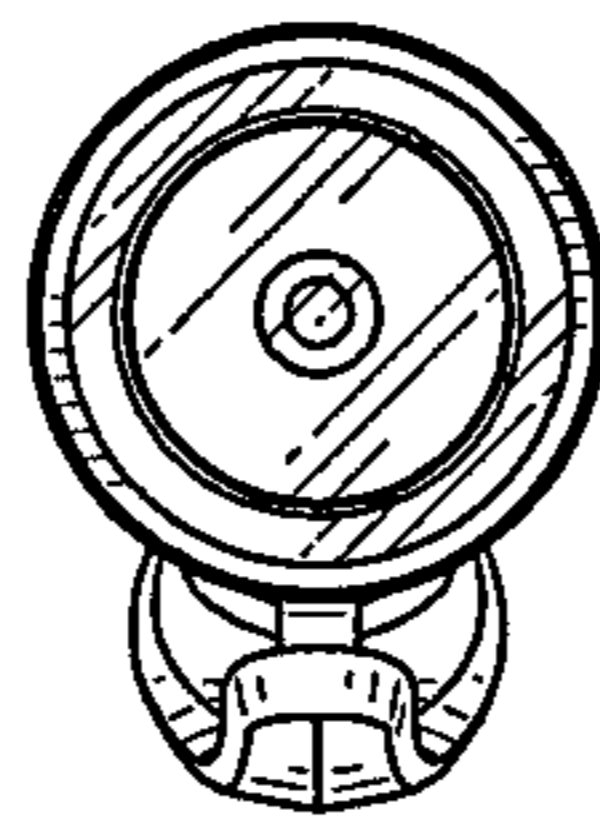

FIG. 6

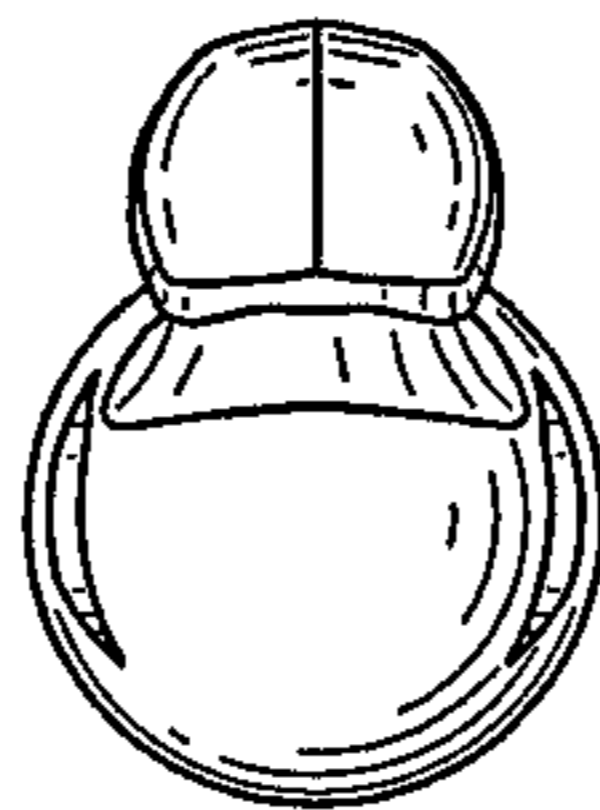

FIG. 5

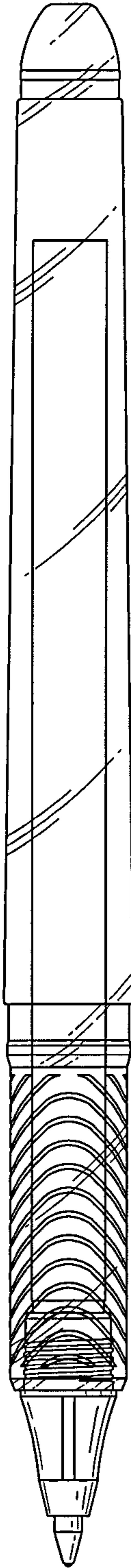

FIG. 7

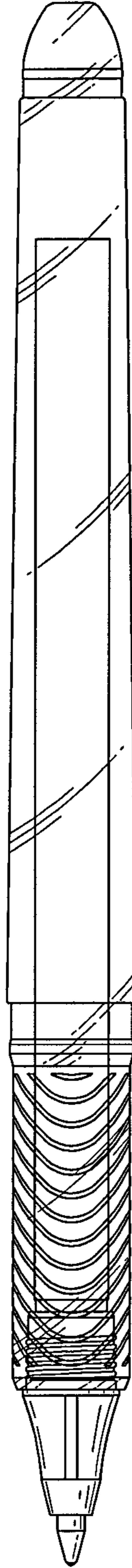

FIG. 8