



US00D713868S

(12) **United States Design Patent**
Yang et al.

(10) **Patent No.:** **US D713,868 S**

(45) **Date of Patent:** **** Sep. 23, 2014**

(54) **WIRELESS IP CAMERA**

(71) Applicant: **Amaryllo International B.V.**, Hsinchu County (TW)

(72) Inventors: **Chao-Tung Yang**, Hsinchu County (TW); **Shu-Hua Liu**, Hsinchu County (TW); **Ling-Ling Wu**, Hsinchu County (TW)

(73) Assignee: **Amaryllo International B.V.**, Hsinchu County (TW)

(**) Term: **14 Years**

(21) Appl. No.: **29/458,411**

(22) Filed: **Jun. 19, 2013**

(51) **LOC (10) Cl.** **16-01**

(52) **U.S. Cl.**
USPC **D16/202**

(58) **Field of Classification Search**

CPC G03B 17/02; G03B 19/04; G03B 17/56;
G03B 17/04; G03B 15/03; H04N 5/2251;
H04N 5/2252; H04N 5/2253; H04N 5/2254;
H04N 2007/145; H04N 7/141; H04N 7/142;
H04N 7/147; H04N 7/148; H04N 7/15;
H04N 7/152
USPC D16/200, 202–205, 208, 218, 219;
D14/209.1; 348/14.01–14.06, 143,
348/148, 373–376; 396/427, 535, 539–541

See application file for complete search history.

(56) **References Cited**

U.S. PATENT DOCUMENTS

D113,220	S	*	2/1939	Crumrine	D16/218
D118,296	S	*	12/1939	Tuomey	D16/205
D332,460	S	*	1/1993	Mohri	D16/219
D377,940	S	*	2/1997	Totsch	D16/202
D441,386	S	*	5/2001	Yamazaki	D16/203
D504,904	S	*	5/2005	Nagai et al.	D16/203
D531,199	S	*	10/2006	Matsuda	D16/202
D616,480	S	*	5/2010	Ookawa et al.	D16/218
D684,560	S	*	6/2013	Lee et al.	D14/209.1
2013/0242181	A1	*	9/2013	Phoon et al.	348/374

* cited by examiner

Primary Examiner — Adir Aronovich

Assistant Examiner — Ramzi Almatrahi

(74) *Attorney, Agent, or Firm* — Chun-Ming Shih

(57) **CLAIM**

The ornamental design for a wireless IP camera, as shown and described.

DESCRIPTION

FIG. 1 is a front and right perspective view of a wireless IP camera showing our new design;
FIG. 2 is a front elevation view thereof;
FIG. 3 is a rear elevation view thereof;
FIG. 4 is a left side elevation view thereof;
FIG. 5 is a right side elevation view thereof;
FIG. 6 is a top plan view thereof;
FIG. 7 is a bottom plan view thereof; and,
FIG. 8 is a rear and right perspective view thereof.

1 Claim, 5 Drawing Sheets

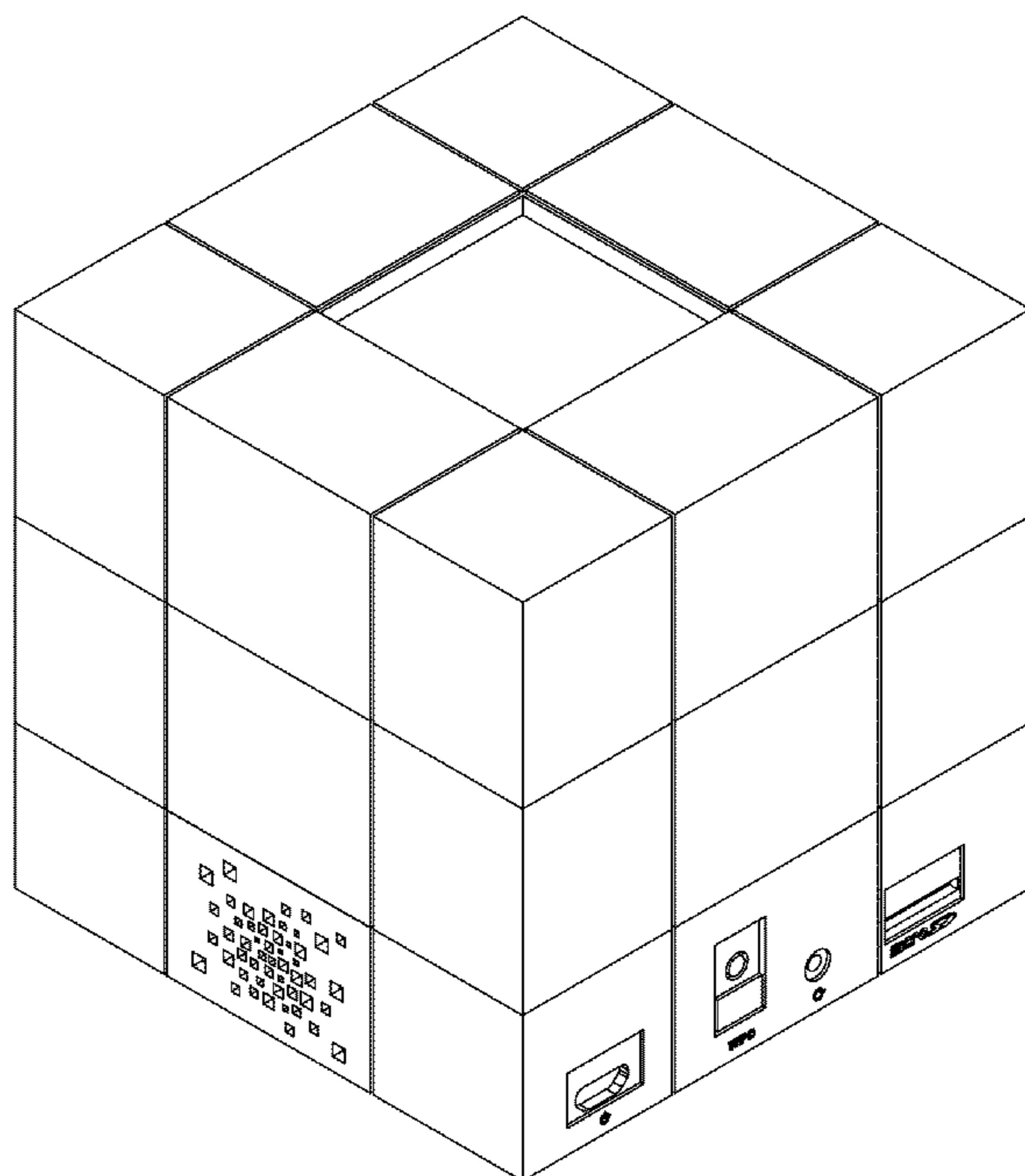
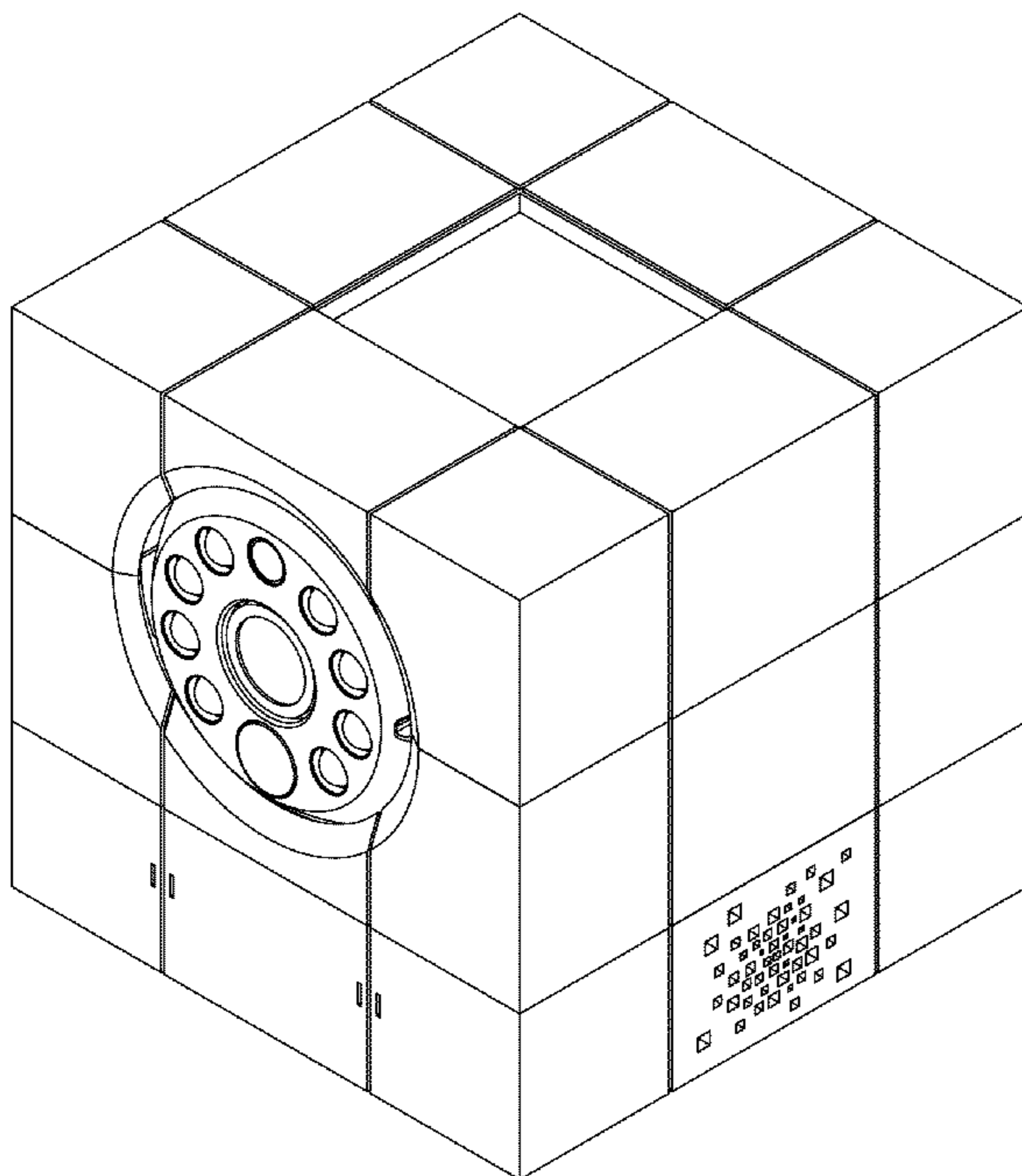

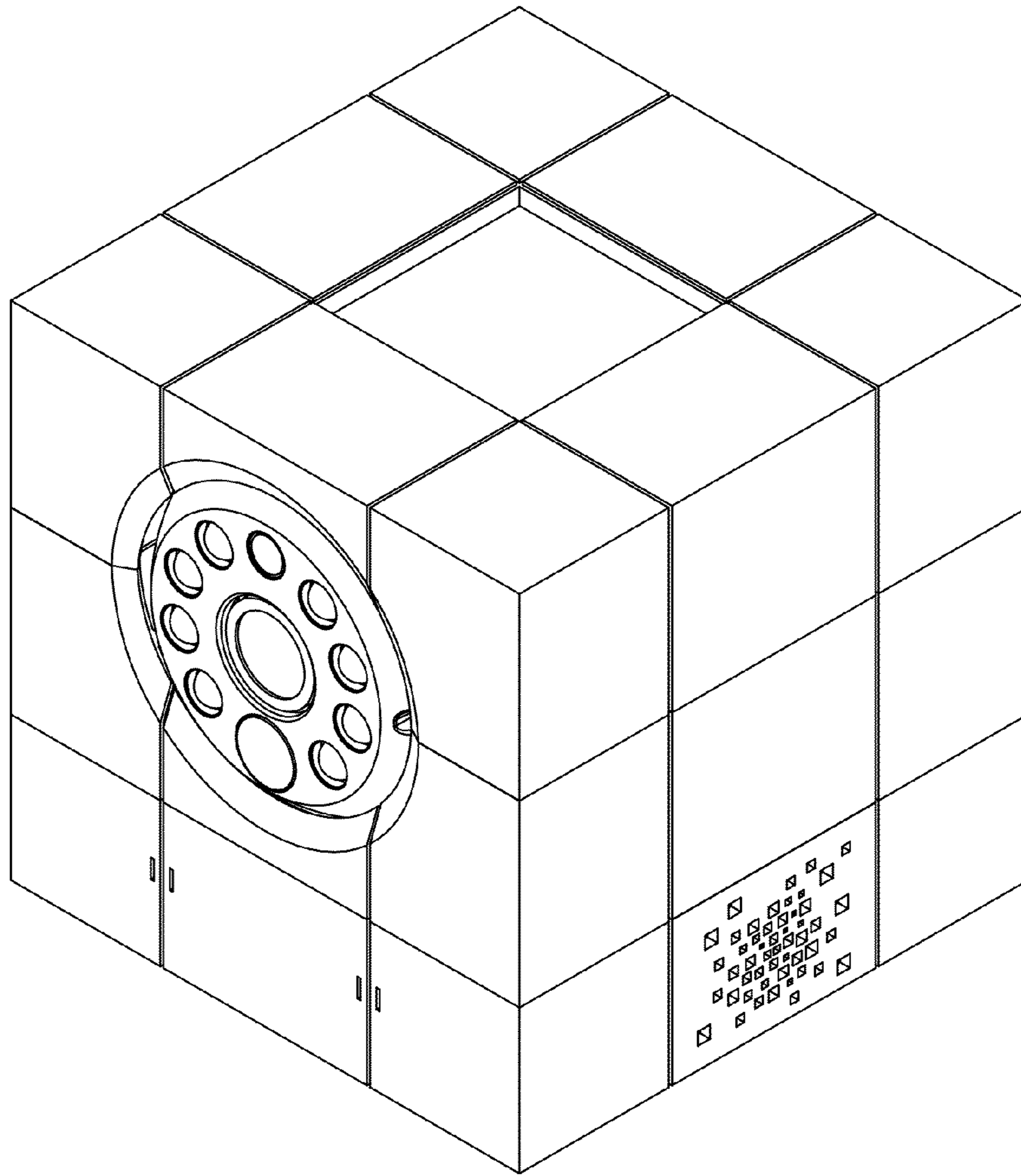

FIG. 1

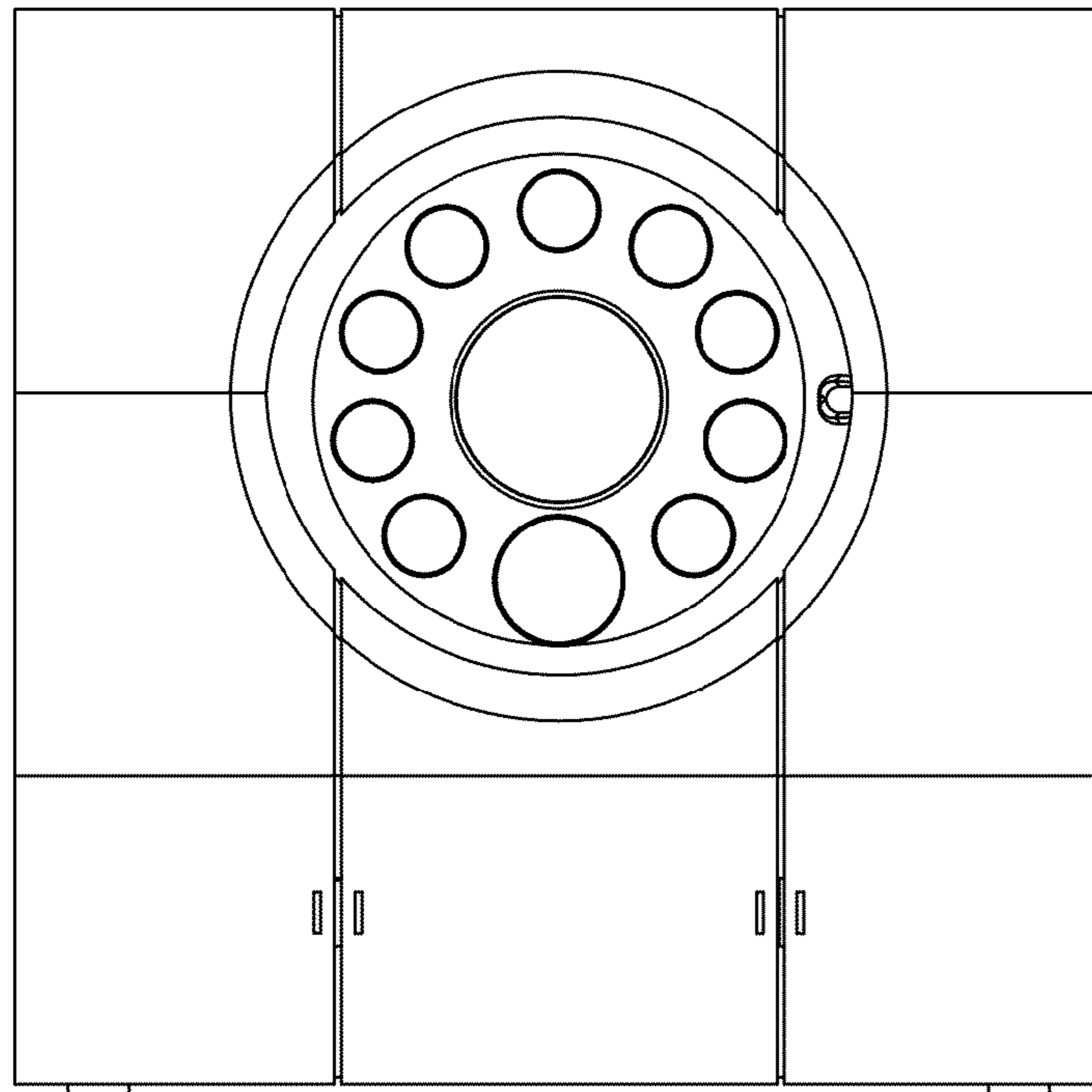

FIG. 2

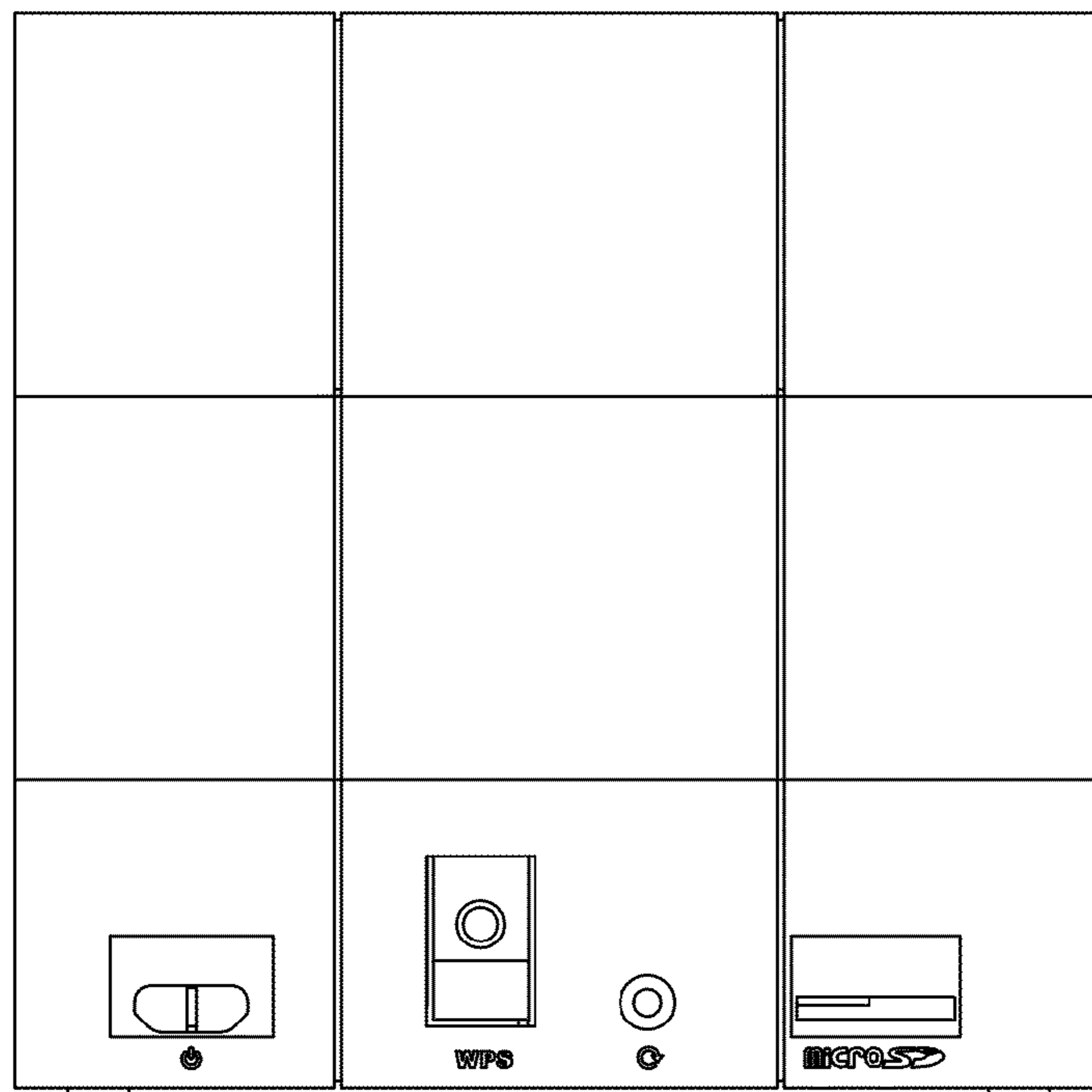

FIG. 3

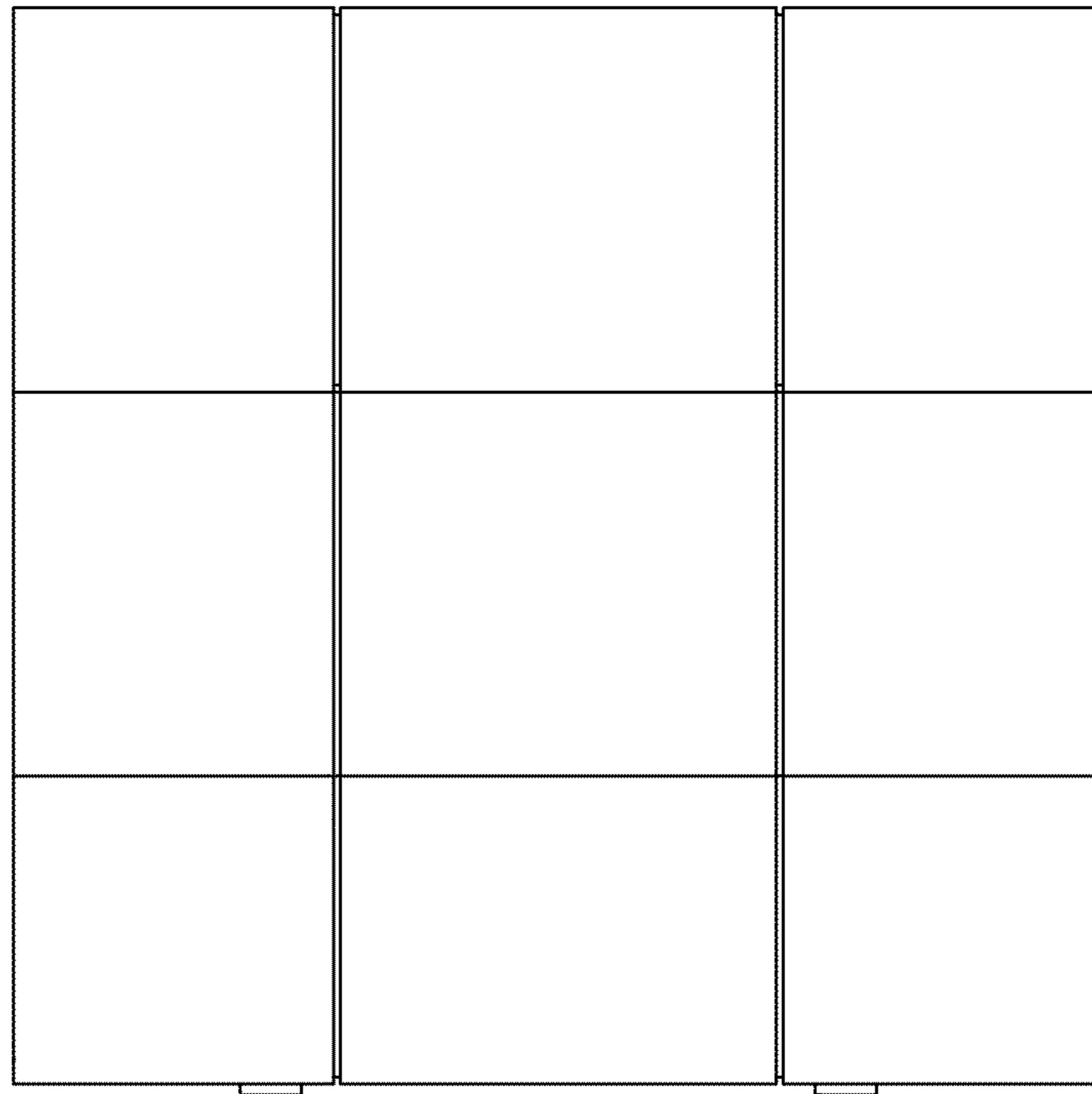

FIG. 4

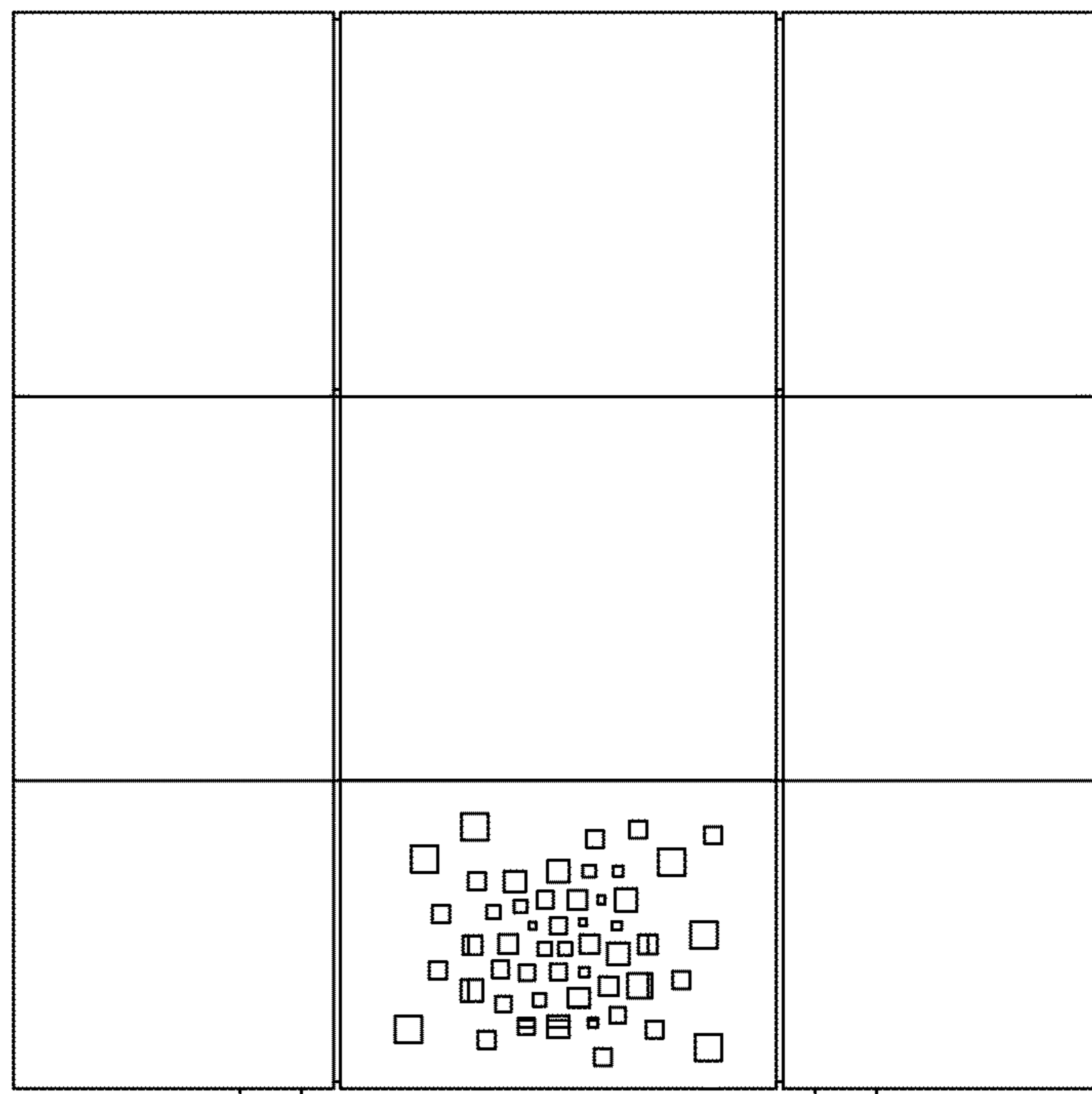

FIG. 5

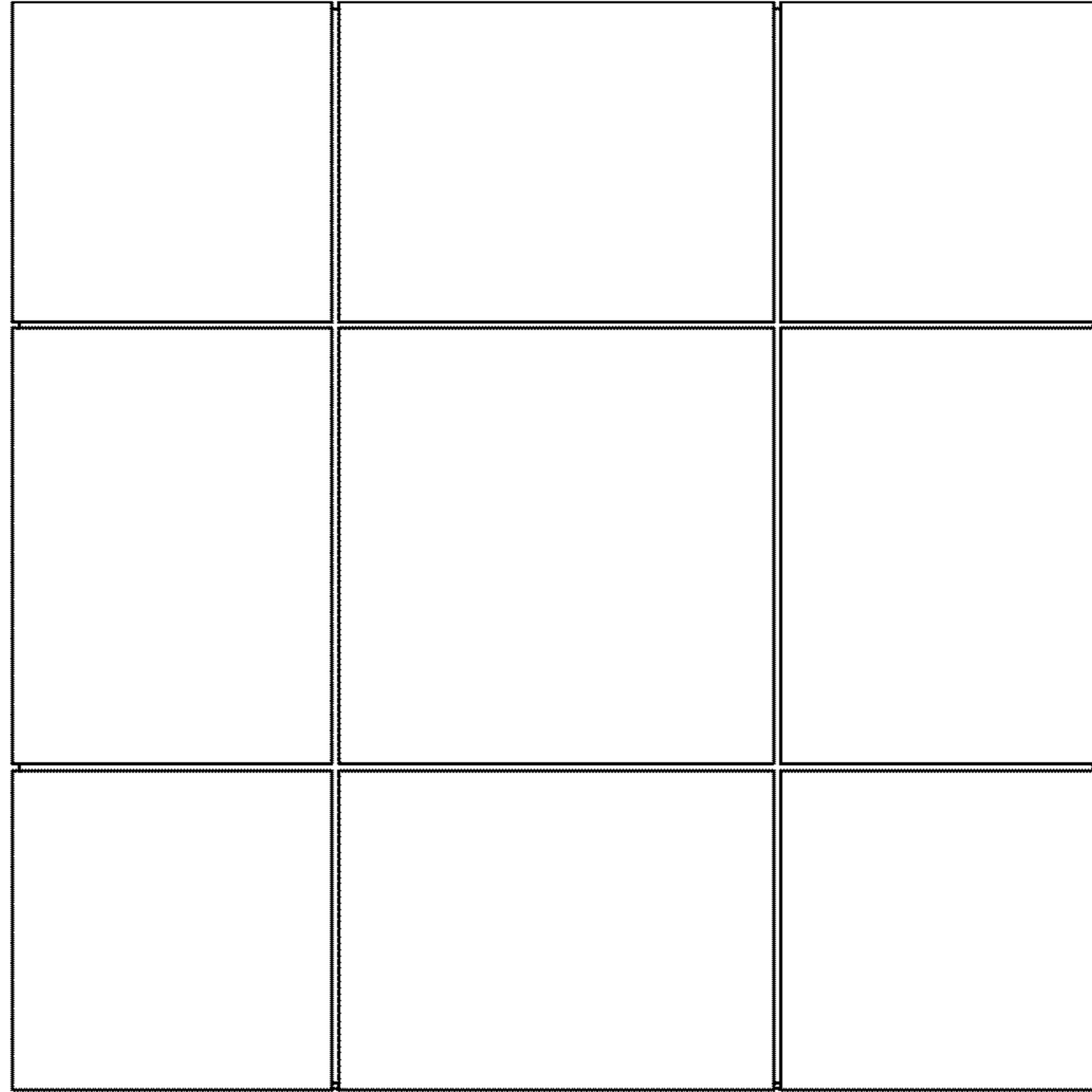

FIG. 6

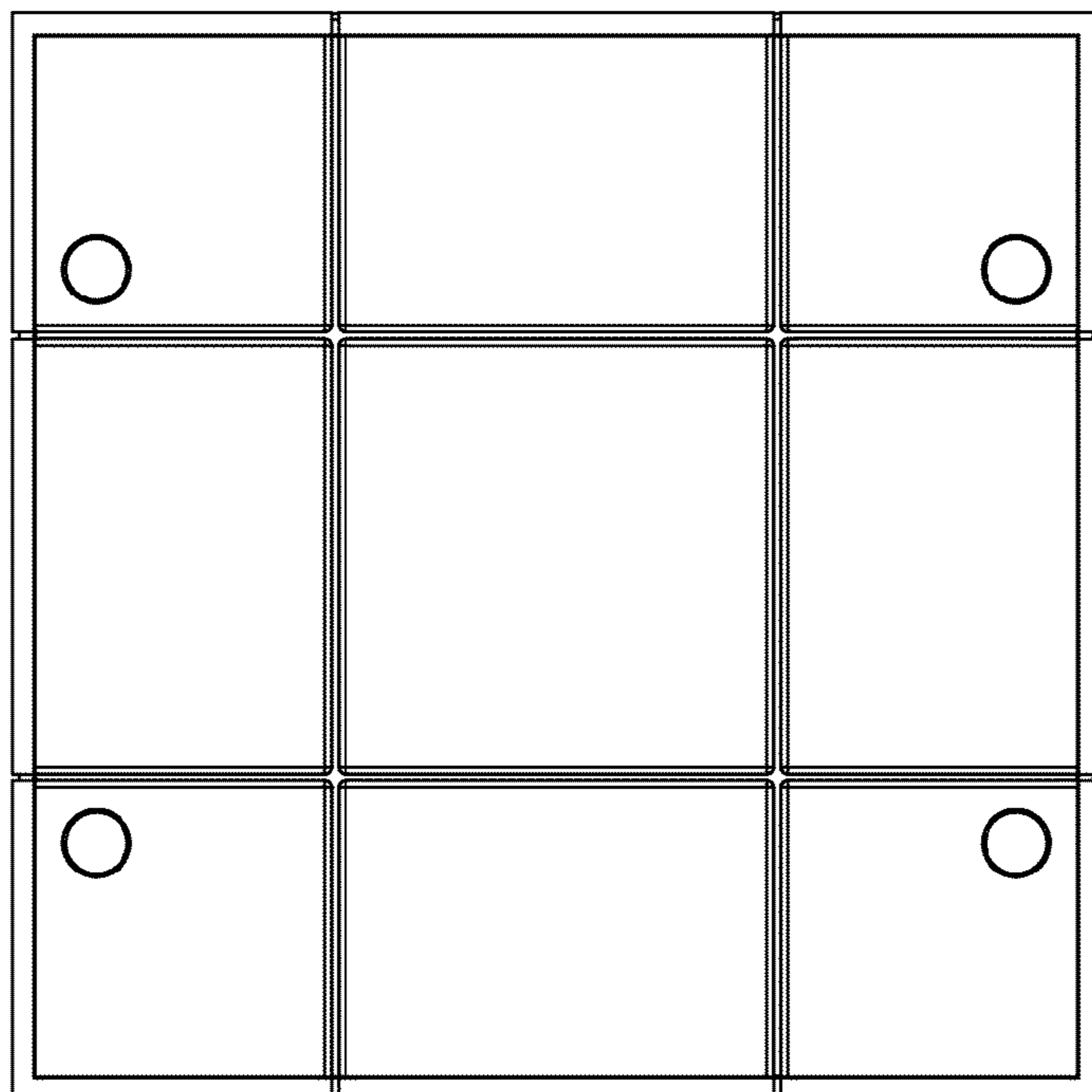

FIG. 7

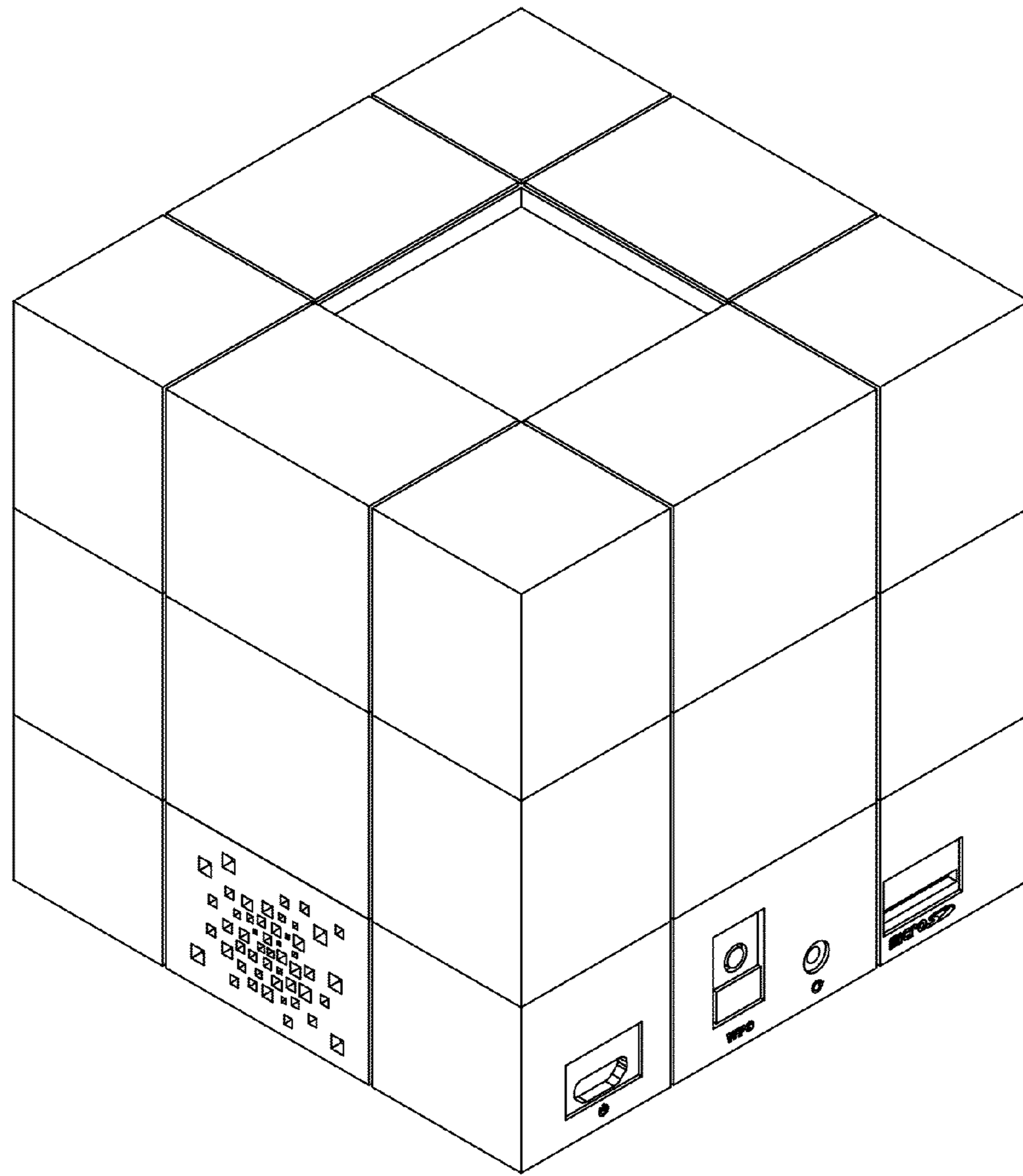

FIG. 8