



US00D713862S

(12) **United States Design Patent**
Lee et al.

(10) **Patent No.:** **US D713,862 S**
(45) **Date of Patent:** **** Sep. 23, 2014**

(54) **REFRIGERATOR**

(71) Applicant: **LG Electronics Inc.**, Seoul (KR)

(72) Inventors: **Hangbok Lee**, Gyeonggi-do (KR);
Kiwan Nahm, Seoul (KR); **Gilsu Jung**,
Seoul (KR); **Hyokku Kwon**, Seoul
(KR); **Kyutae Park**, Gyeonggi-do (KR)

(73) Assignee: **LG Electronics Inc.**, Seoul (KR)

(**) Term: **14 Years**

(21) Appl. No.: **29/457,651**

(22) Filed: **Jun. 12, 2013**

(30) **Foreign Application Priority Data**

Dec. 17, 2012 (KR) 30-2012-0060792

(51) **LOC (10) Cl.** **15-07**

(52) **U.S. Cl.**
USPC **D15/86**

(58) **Field of Classification Search**
USPC D15/79-91; 62/440-449, 3.1, 3.6, 3.64,
62/246-255, 337; 312/138.1, 139.2, 236,
312/400-408, 352

See application file for complete search history.

(56) **References Cited**

U.S. PATENT DOCUMENTS

D629,021 S * 12/2010 Cho et al. D15/85
D655,321 S * 3/2012 Lee et al. D15/86

D658,215 S * 4/2012 Seo et al. D15/86
D672,375 S * 12/2012 Lee et al. D15/86
D674,415 S * 1/2013 Lee et al. D15/86
D678,922 S * 3/2013 Lee et al. D15/86
D680,138 S * 4/2013 Seo et al. D15/86
D681,695 S * 5/2013 Lee et al. D15/86
D684,609 S * 6/2013 Seo et al. D15/86
D692,033 S * 10/2013 Choi et al. D15/86
D700,222 S * 2/2014 Sin et al. D15/89
D702,739 S * 4/2014 Kim D15/86

* cited by examiner

Primary Examiner — Thomas Johannes

Assistant Examiner — Khawaja Anwar

(74) *Attorney, Agent, or Firm* — Morgan, Lewis & Bockius
LLP

(57) **CLAIM**

The ornamental design for a refrigerator, as shown and described.

DESCRIPTION

FIG. 1 is a perspective view of a refrigerator showing our new design;

FIG. 2 is a front view thereof;

FIG. 3 is a rear view thereof;

FIG. 4 is a left side view thereof;

FIG. 5 is a right side view thereof;

FIG. 6 is a top plan view thereof; and,

FIG. 7 is a bottom plan view thereof.

1 Claim, 7 Drawing Sheets

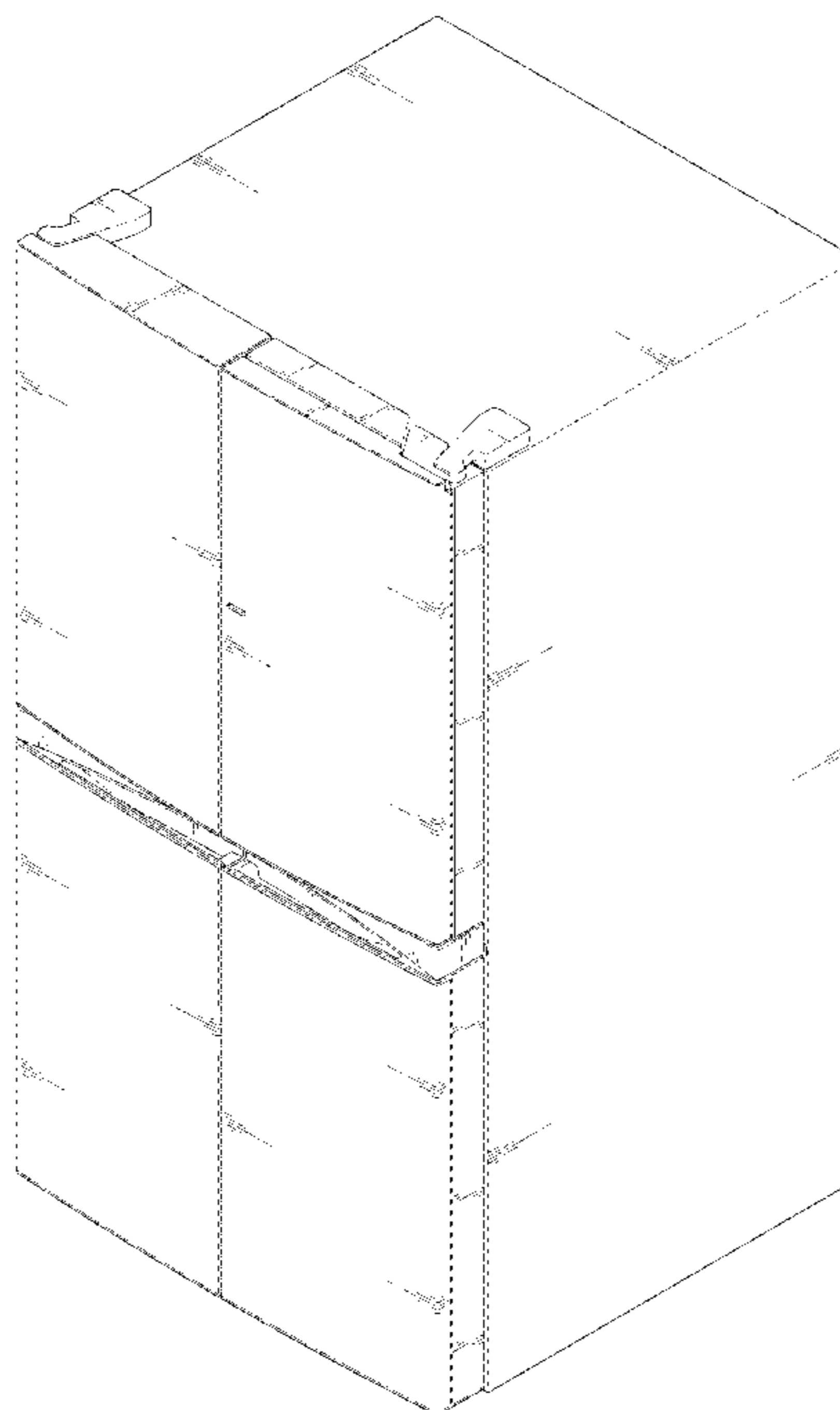

FIG. 1

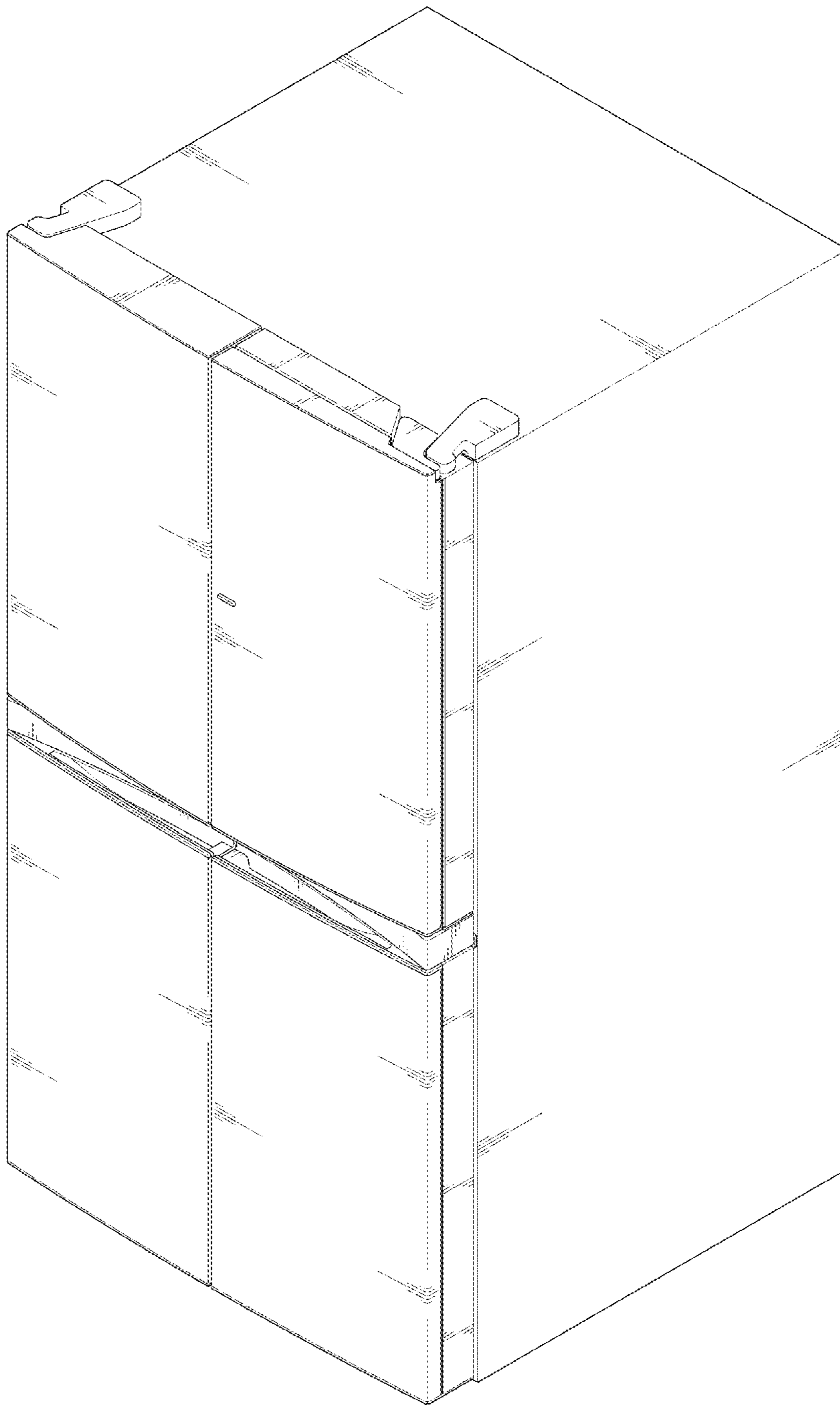

FIG. 2

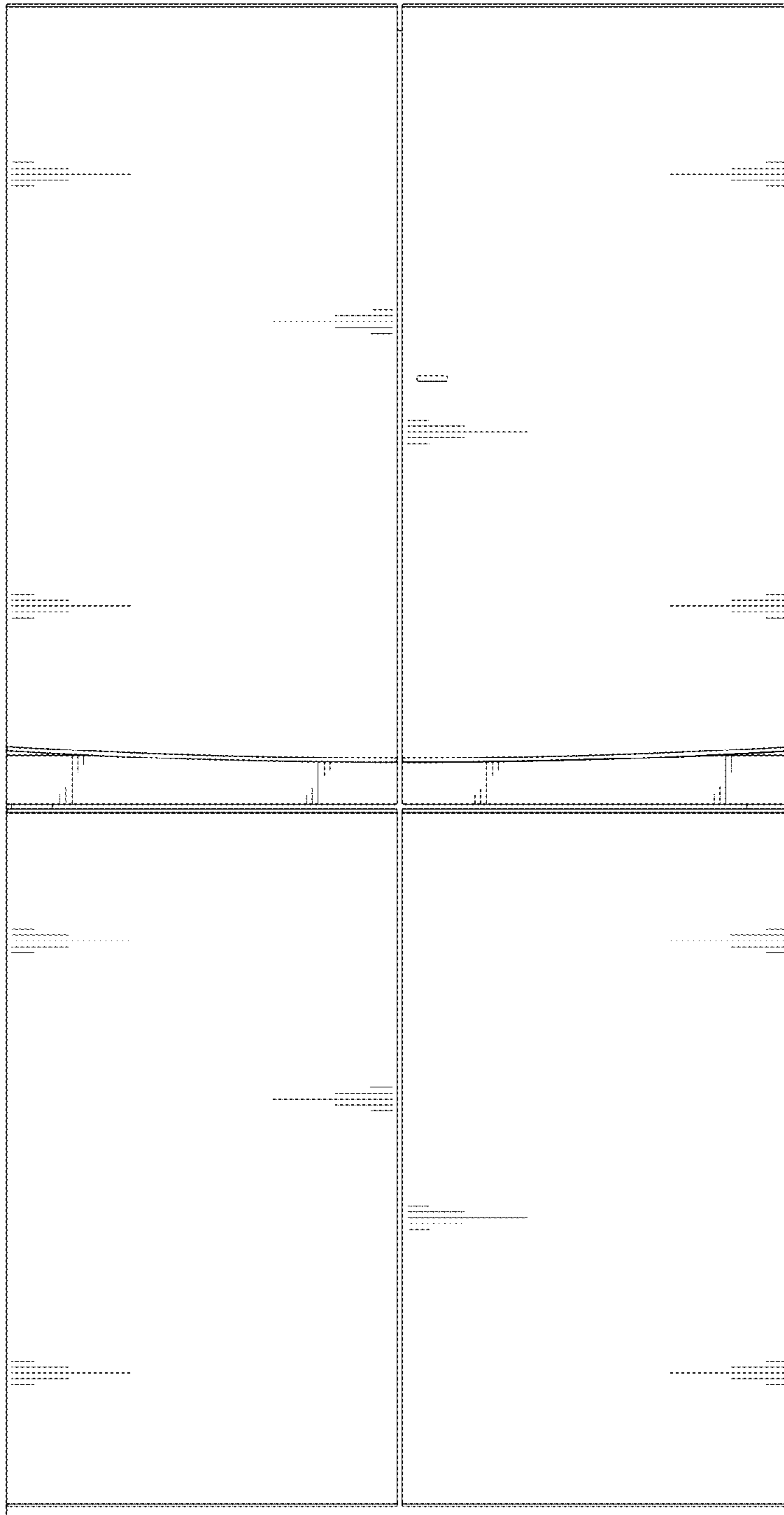

FIG. 3

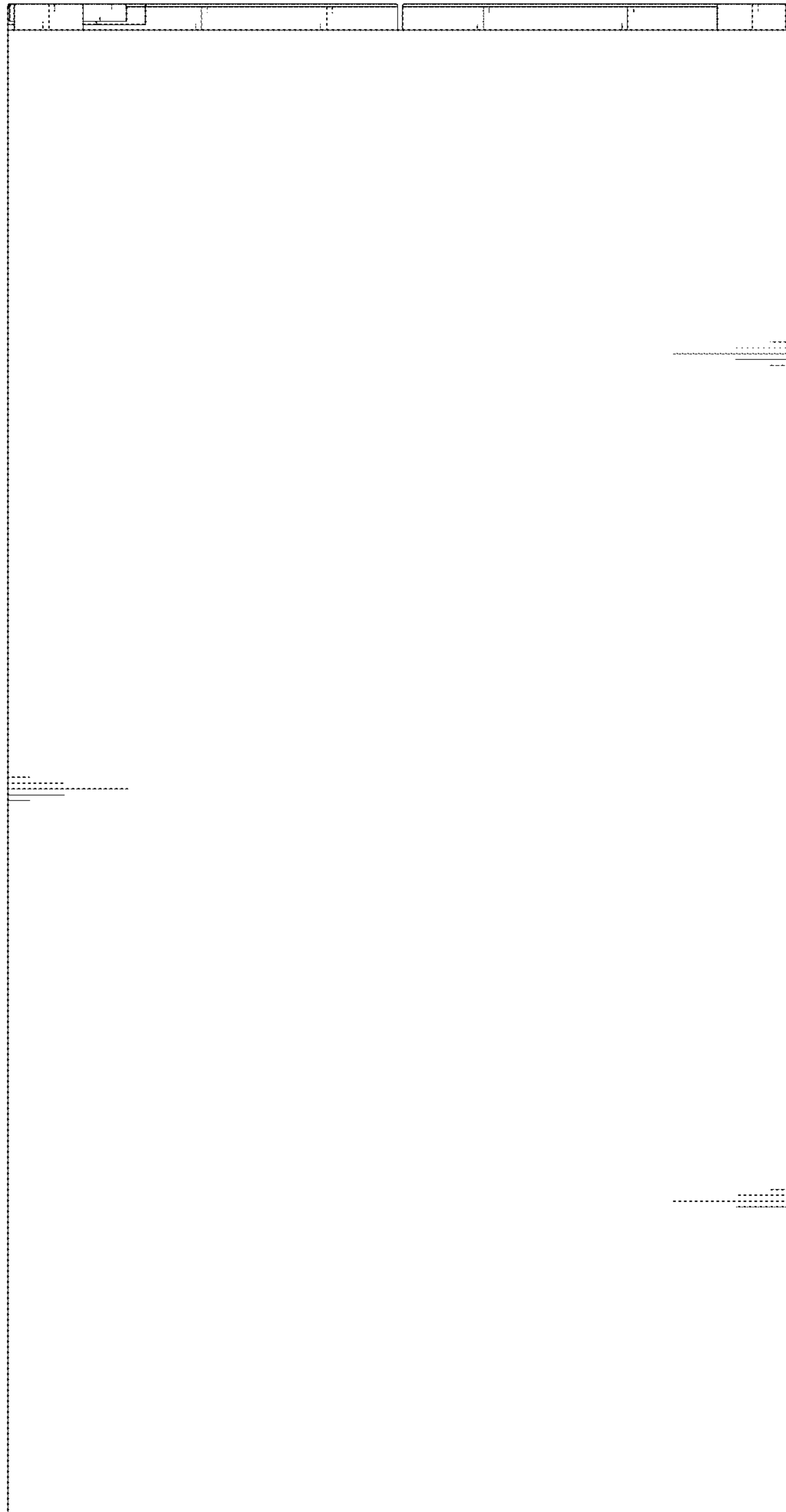

FIG. 4

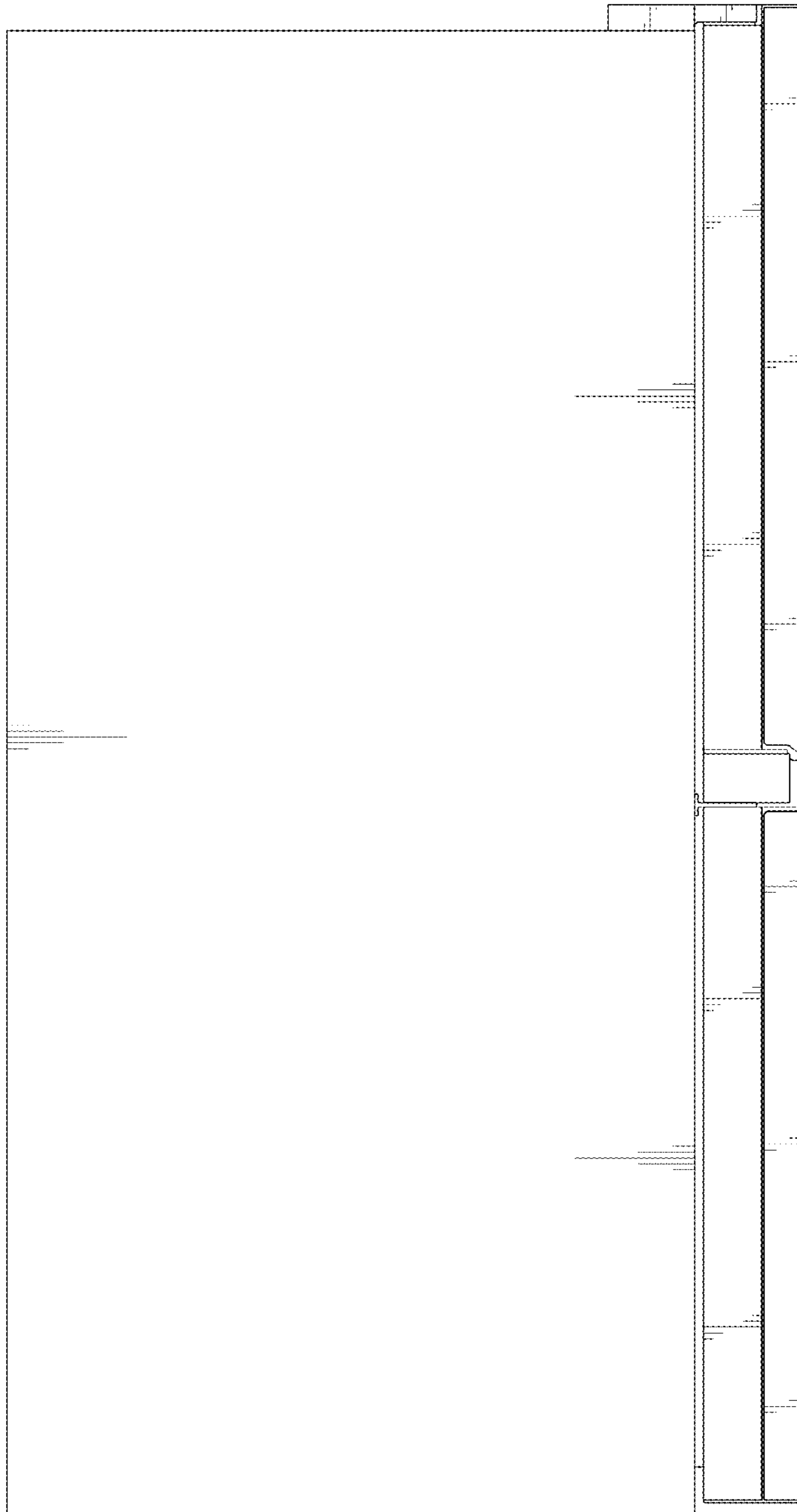

FIG. 5

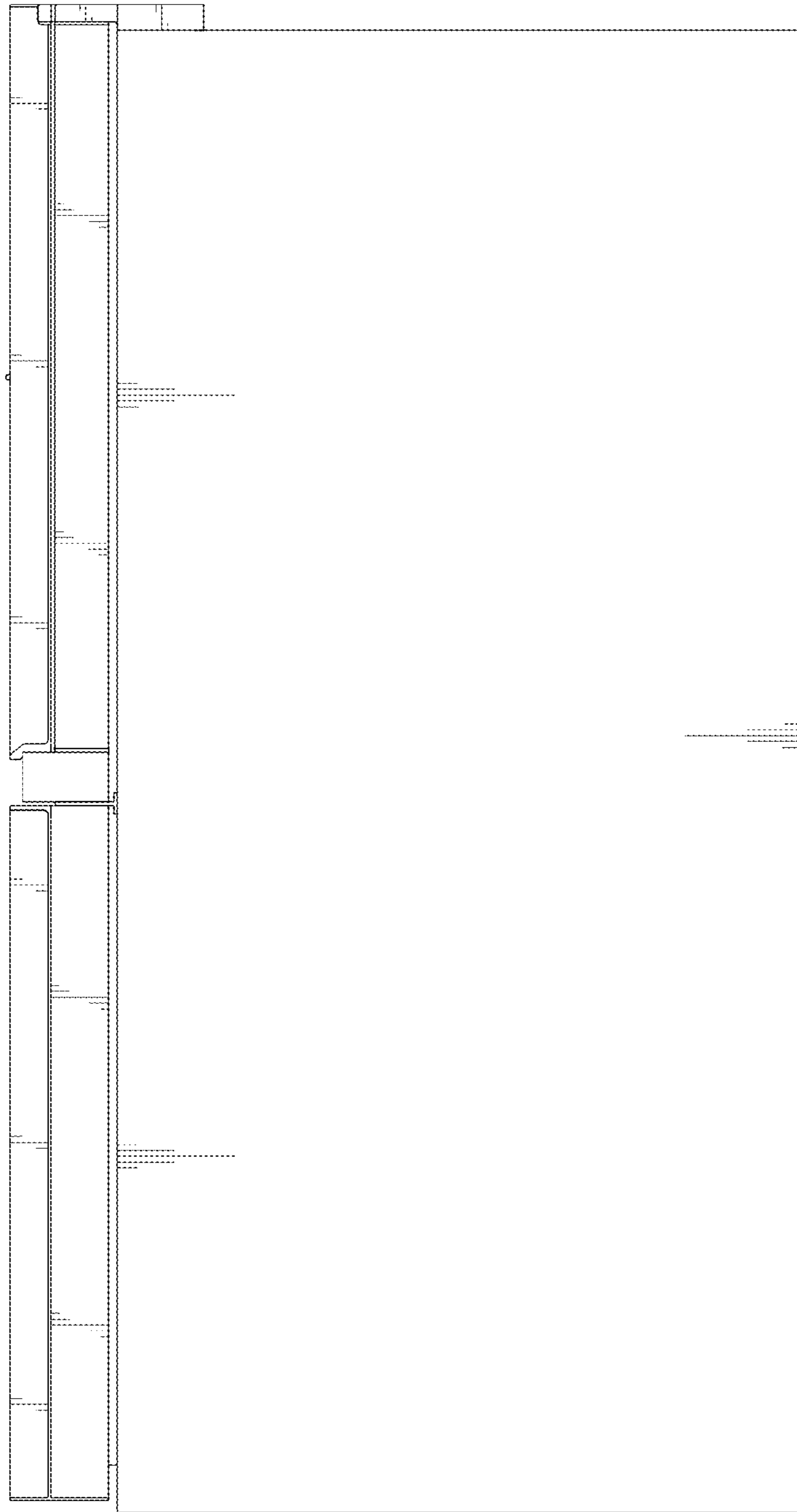

FIG. 6

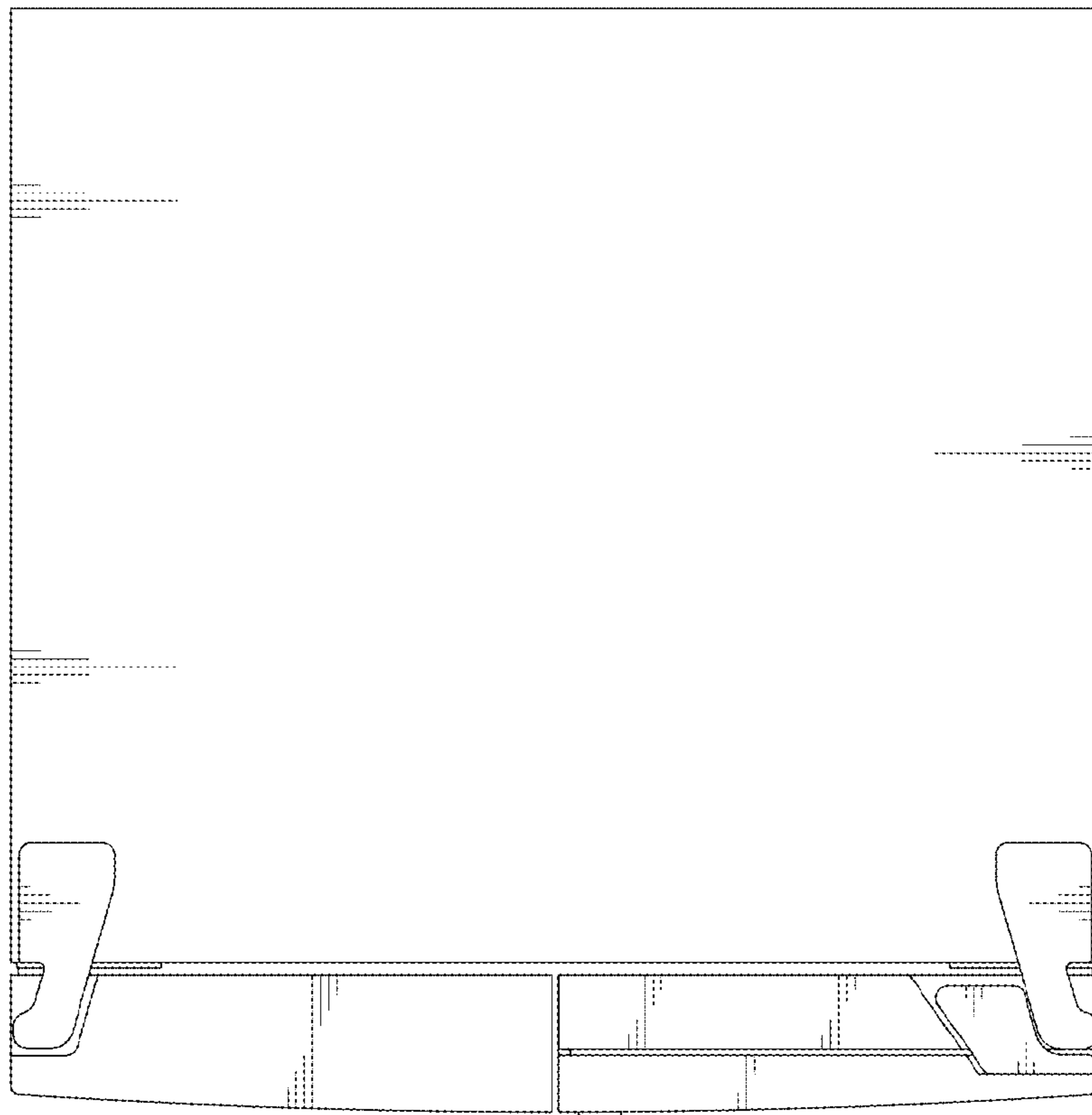

FIG. 7

