



US00D713733S

(12) **United States Design Patent**
Ford

(10) **Patent No.:** **US D713,733 S**
(45) **Date of Patent:** **** Sep. 23, 2014**

(54) **BOTTLE**

(71) Applicant: **Mark Hunter Ford**, Wilmington, NC
(US)

(72) Inventor: **Mark Hunter Ford**, Wilmington, NC
(US)

(**) Term: **14 Years**

(21) Appl. No.: **29/458,738**

(22) Filed: **Jun. 21, 2013**

(51) **LOC (10) Cl.** **09-01**

(52) **U.S. Cl.**

USPC **D9/649**; D9/548

(58) **Field of Classification Search**

USPC D7/514–515, 613, 619.2, 599; D9/600,
D9/649, 500–504, 516, 522, 544–546,
D9/548; 206/457, 527, 540; 220/890

See application file for complete search history.

(56) **References Cited**

U.S. PATENT DOCUMENTS

D172,316 S * 5/1954 Sanford D9/649
D316,960 S * 5/1991 Wilkerson D9/649

(Continued)

OTHER PUBLICATIONS

Jim Beam Brands Co.,S.C.-shaped bottle, “Jim Beam Whiskey
Decanters” webpage on <http://home.netcom.com/~dshyer/>, S.C.-
shaped bottle on p. 3 of 4, picture on p. 5, circa 1970.

(Continued)

Primary Examiner — Sandra Morris

(74) *Attorney, Agent, or Firm* — J. Bennett Mullinax, LLC

(57) **CLAIM**

The ornamental design for a bottle, as shown and described.

DESCRIPTION

FIG. 1 is a front bottom perspective view of a transparent
and/or translucent embodiment of a bottle according to the
present design;

FIG. 2 is a front perspective view of the embodiment of the
bottle as shown in FIG. 1;

FIG. 3 is a front view of the embodiment of the bottle as
shown in FIG. 1;

FIG. 4 is a back view of the embodiment of the bottle as
shown in FIG. 1;

FIG. 5 is a top view of the embodiment of the bottle as shown
in FIG. 1;

FIG. 6 is a bottom view of the embodiment of the bottle as
shown in FIG. 1;

FIG. 7 is a left side of the embodiment of the bottle as shown
in FIG. 1;

FIG. 8 is a right side of the embodiment of the bottle as shown
in FIG. 1;

FIG. 9 is a front bottom perspective view of another embodi-
ment of a bottle according to the present design;

FIG. 10 is a front perspective view of the embodiment of the
bottle as shown in FIG. 9;

FIG. 11 is a front view of the embodiment of the bottle as
shown in FIG. 9;

FIG. 12 is a back view of the embodiment of the bottle as
shown in FIG. 9;

FIG. 13 is a top view of the embodiment of the bottle as shown
in FIG. 9;

FIG. 14 is a bottom view of the embodiment of the bottle as
shown in FIG. 9;

FIG. 15 is a left side of the embodiment of the bottle as shown
in FIG. 9;

FIG. 16 is a right side of the embodiment of the bottle as
shown in FIG. 9;

FIG. 17 is a front bottom perspective view of another embodi-
ment of a bottle according to the present design;

FIG. 18 is a front perspective view of the embodiment of the
bottle as shown in FIG. 17;

FIG. 19 is a front view of the embodiment of the bottle as
shown in FIG. 17;

FIG. 20 is a back view of the embodiment of the bottle as
shown in FIG. 17;

FIG. 21 is a top view of the embodiment of the bottle as shown
in FIG. 17;

FIG. 22 is a bottom view of the embodiment of the bottle as
shown in FIG. 17;

FIG. 23 is a left side of the embodiment of the bottle as shown
in FIG. 17; and,

FIG. 24 is a right side of the embodiment of the bottle as
shown in FIG. 17.

The broken lines shown in the drawing disclosure are for
illustrative purposes only and form no part of the claimed
design.

1 Claim, 15 Drawing Sheets

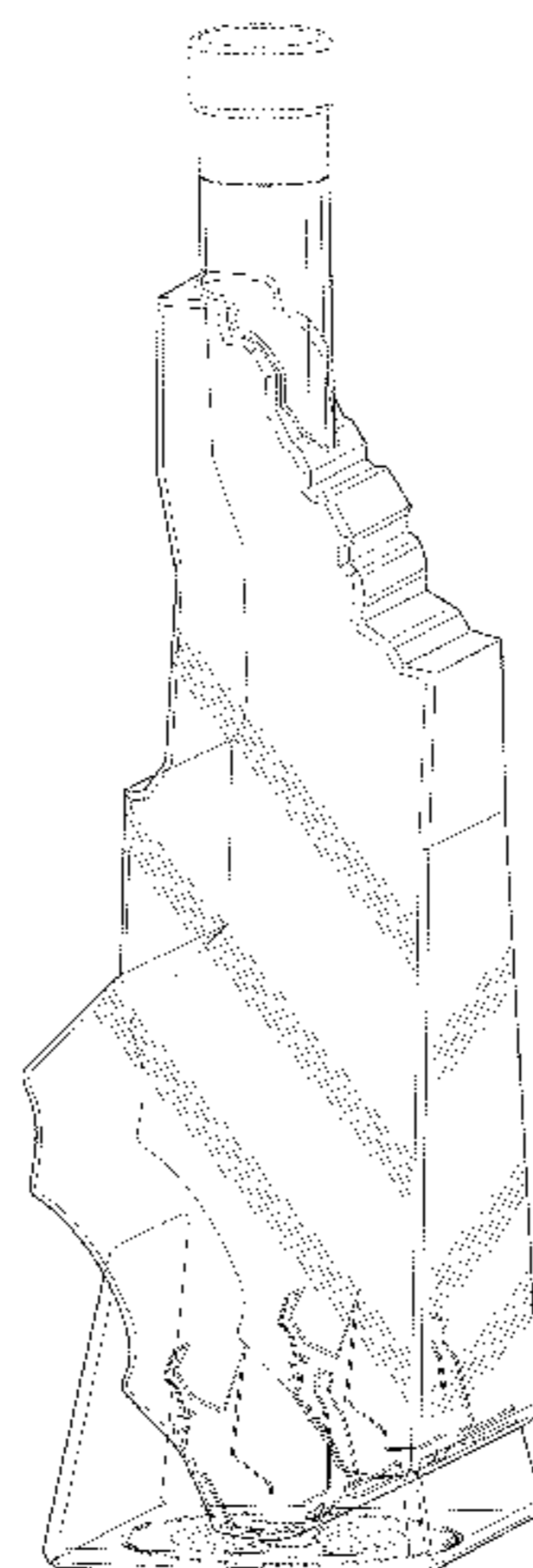

(56)

References Cited

U.S. PATENT DOCUMENTS

D334,138 S * 3/1993 Larsen D9/649
D479,124 S * 9/2003 Pope D9/649
D553,500 S * 10/2007 Bourghol D9/522
D674,700 S * 1/2013 Degener D9/649
D676,331 S 2/2013 Hartford
D676,753 S 2/2013 Badziong
D677,575 S 3/2013 Barnard et al.
D677,577 S 3/2013 Bentley
D678,775 S 3/2013 Daniele

D678,781 S 3/2013 Andreotti
D679,602 S 4/2013 Gonzalez Rodriguez
D679,605 S 4/2013 Bonadio

OTHER PUBLICATIONS

Jim Beam Brands Co., Ohio-shaped bottle, "Jason's Junk" webpage, <http://jasonsjunk.com/showcat.php?cat=27>, Ohio-shaped bottle on p. 2 of 3, picture on p. 4, circa 1966.
Republic Tequila, Texas-shaped bottle, "Republic Tequila Turns into a Big Texas Hit", <http://www.examiner.com>, bottle pictures on pp. 1 & 3, at least as early as Dec. 23, 2009.

* cited by examiner

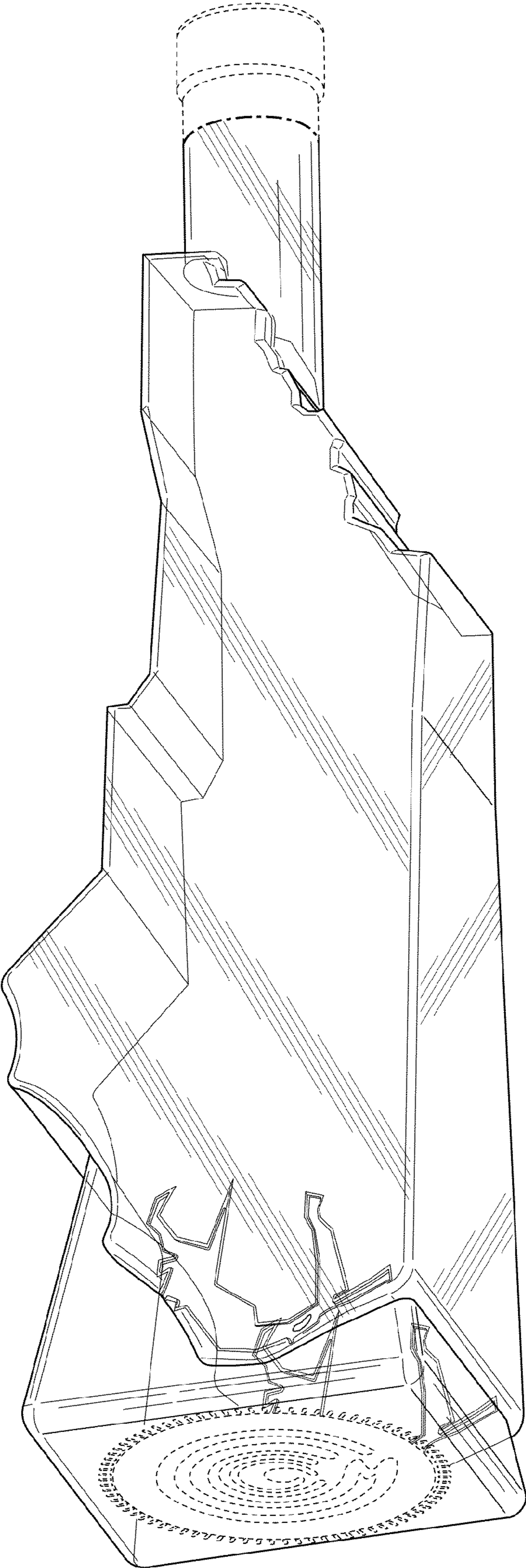

FIG. 1

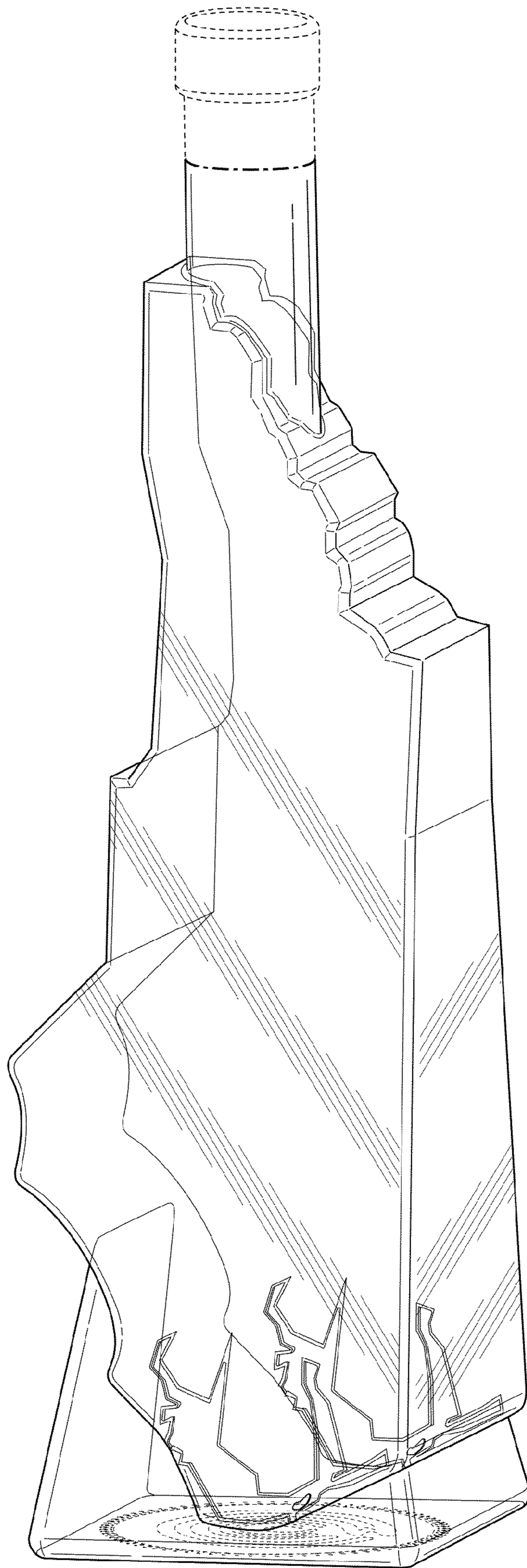

FIG. 2

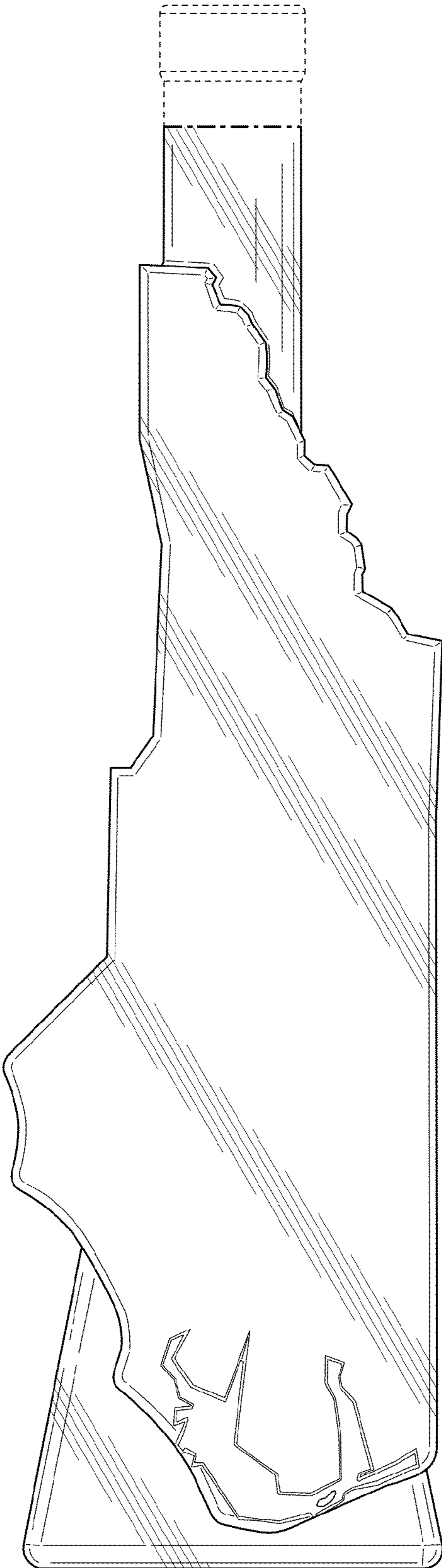

FIG. 3

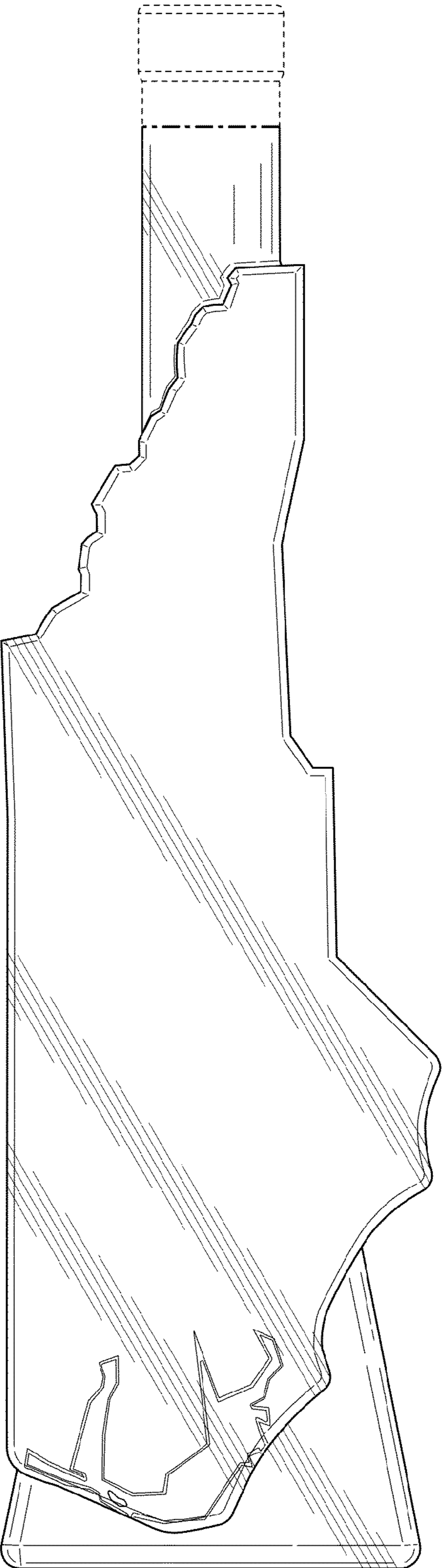

FIG. 4

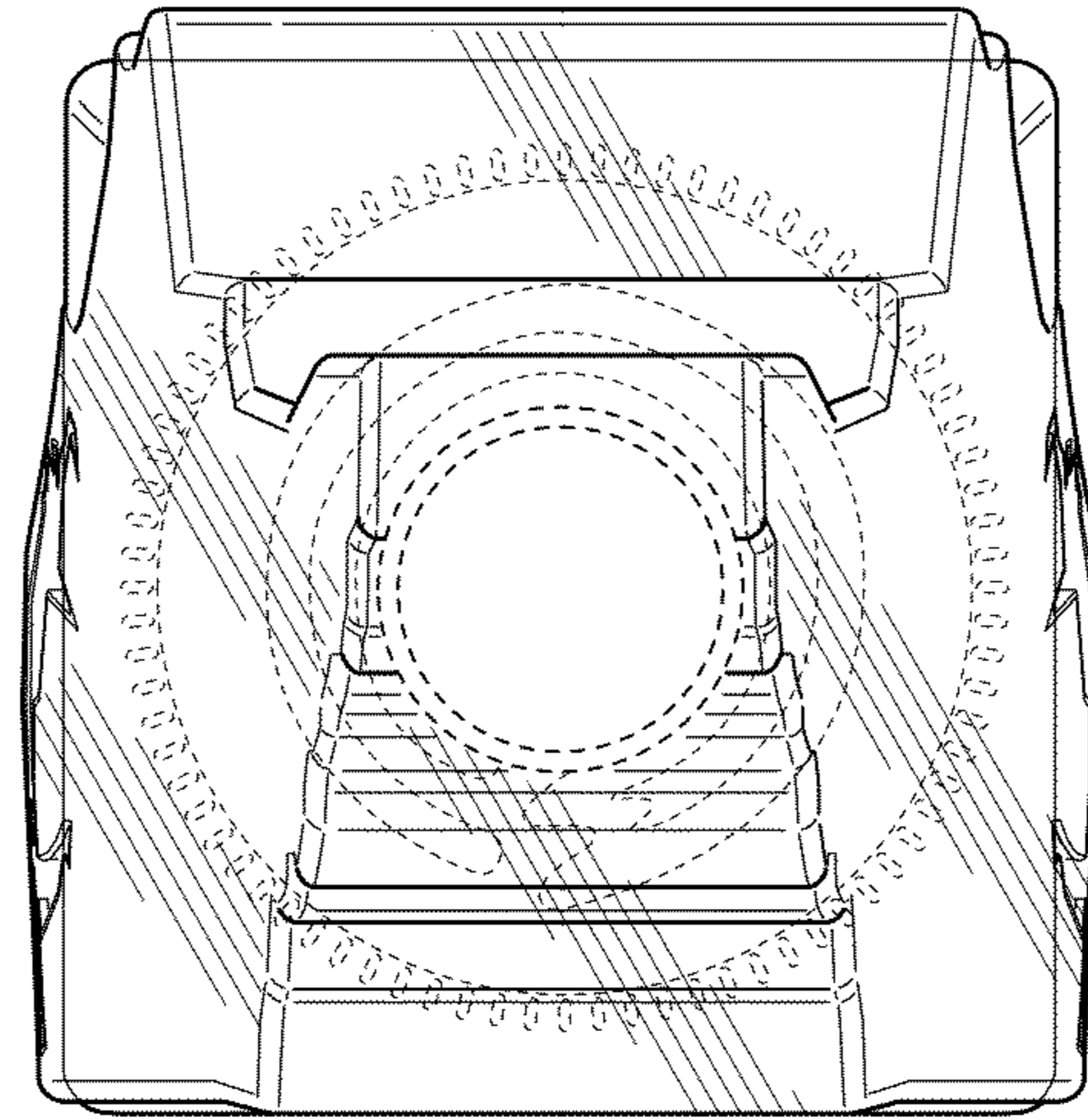

FIG. 5

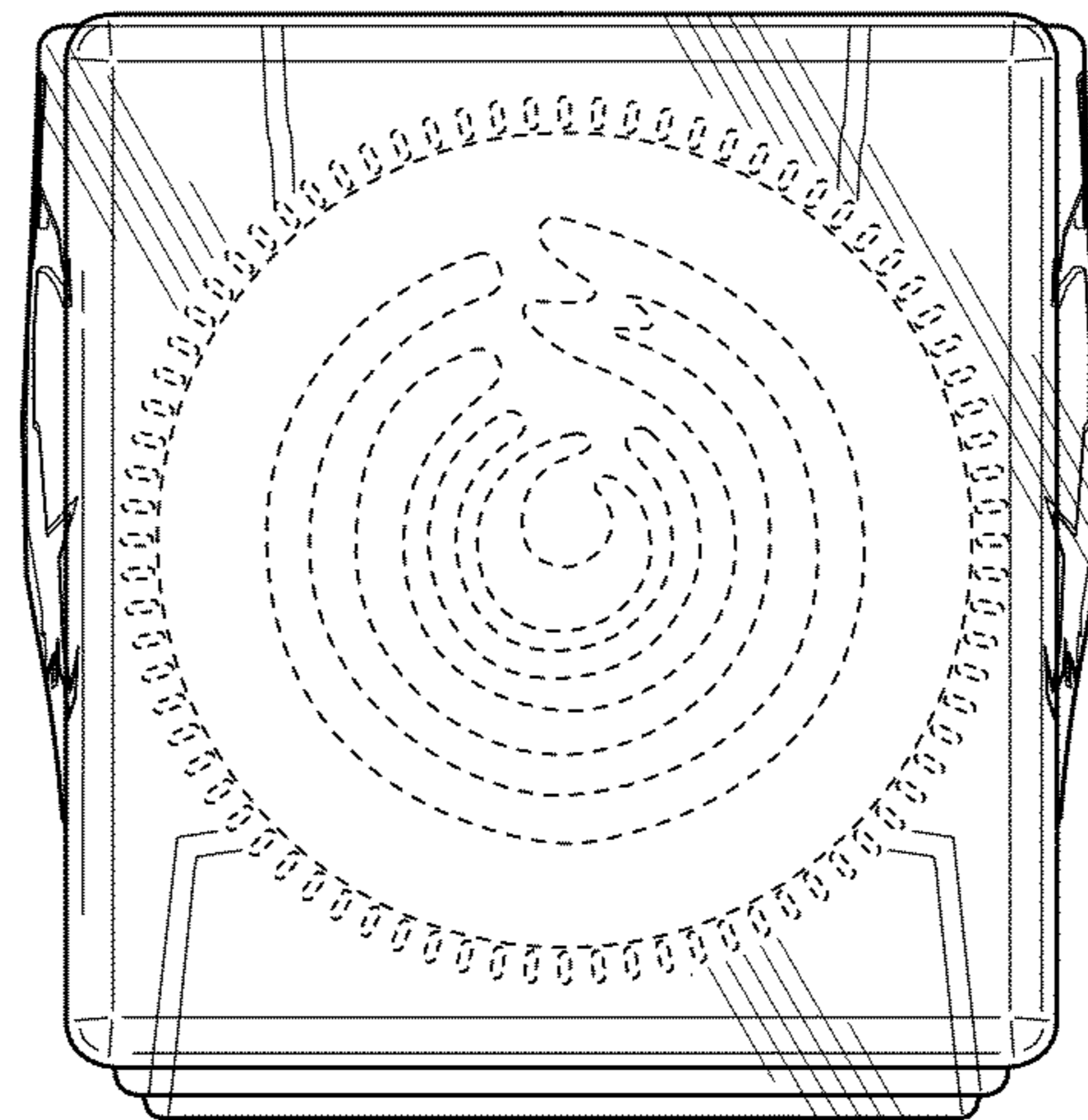

FIG. 6

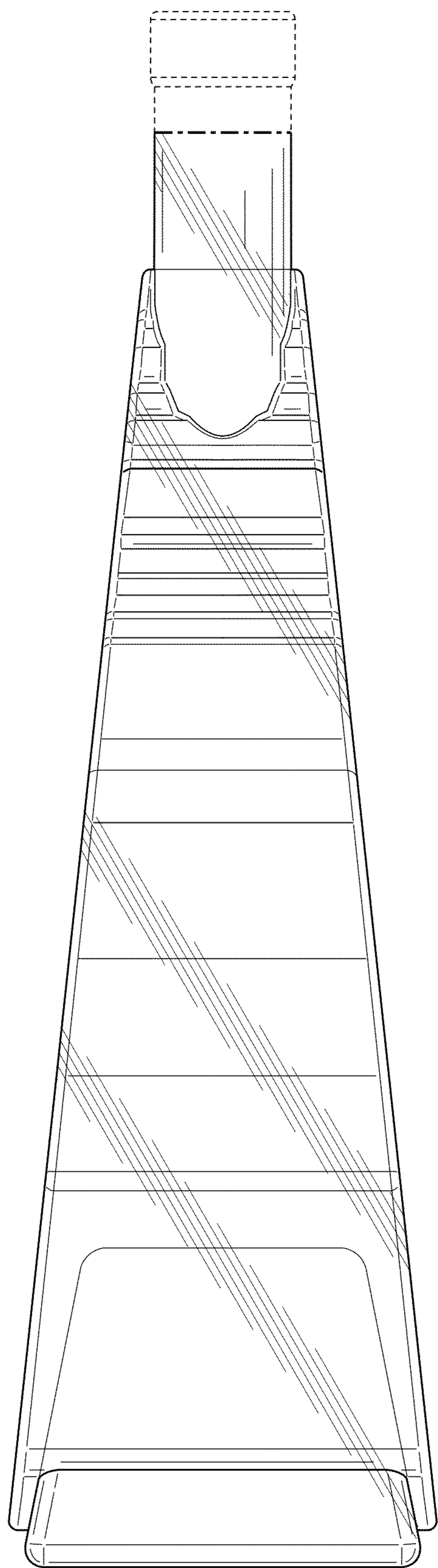

FIG. 7

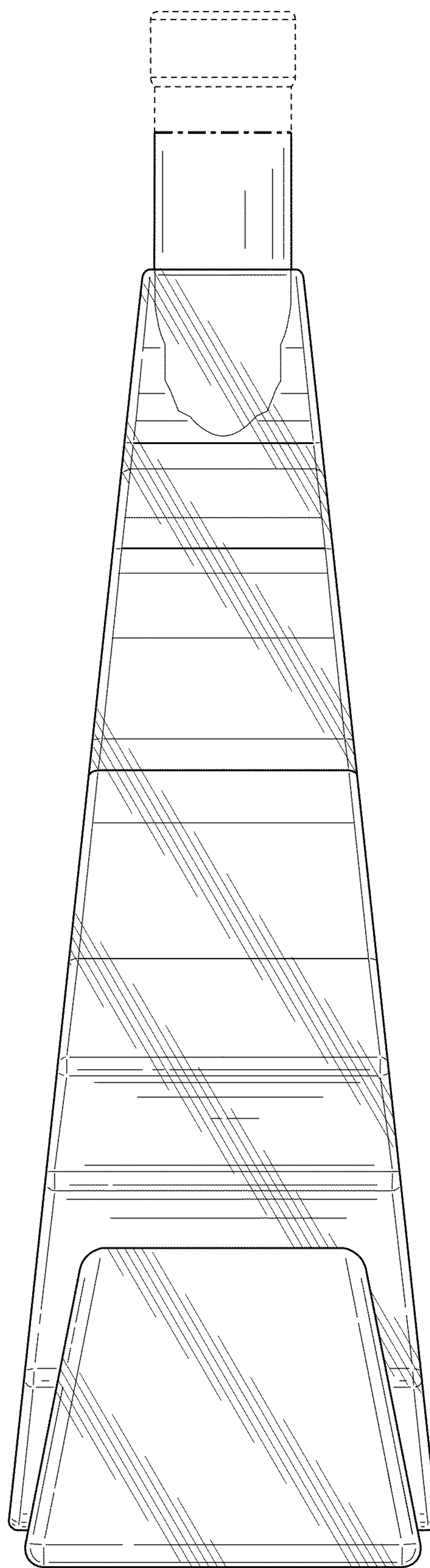

FIG. 8

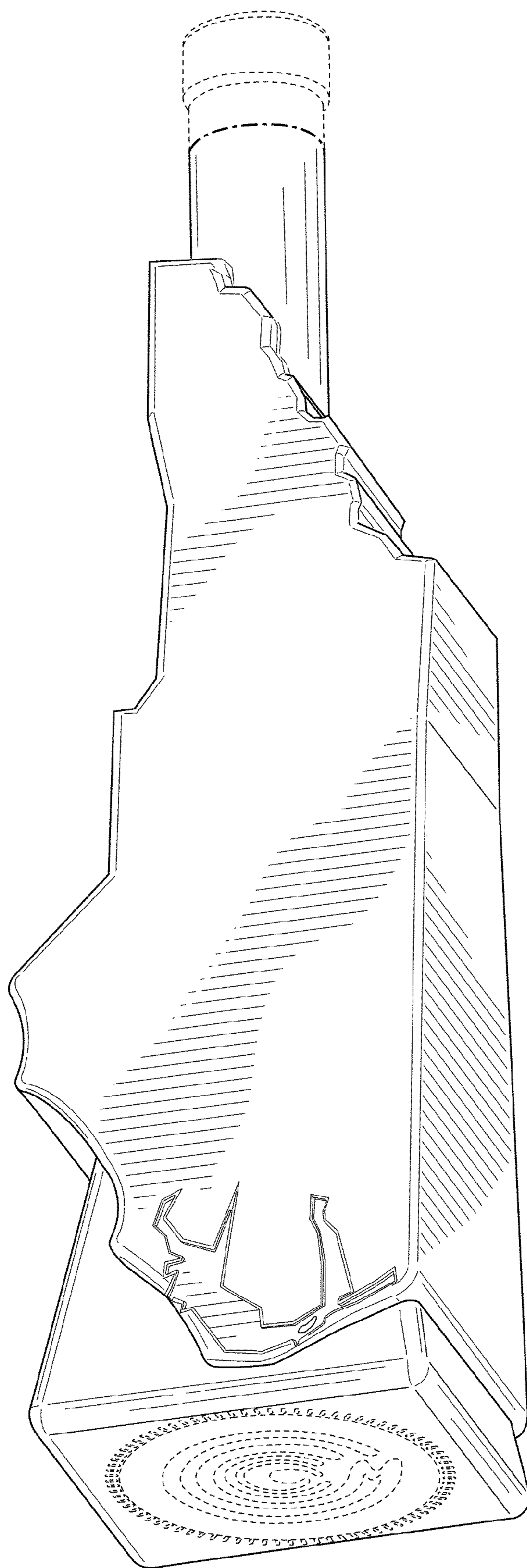

FIG. 9

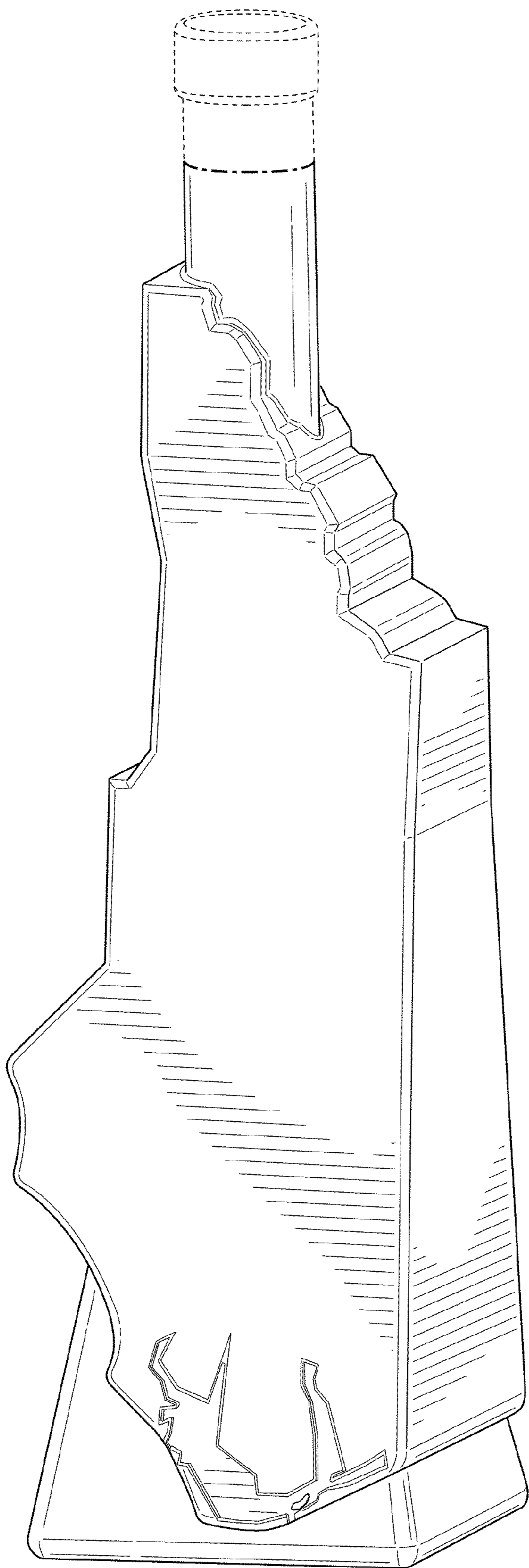

FIG. 10

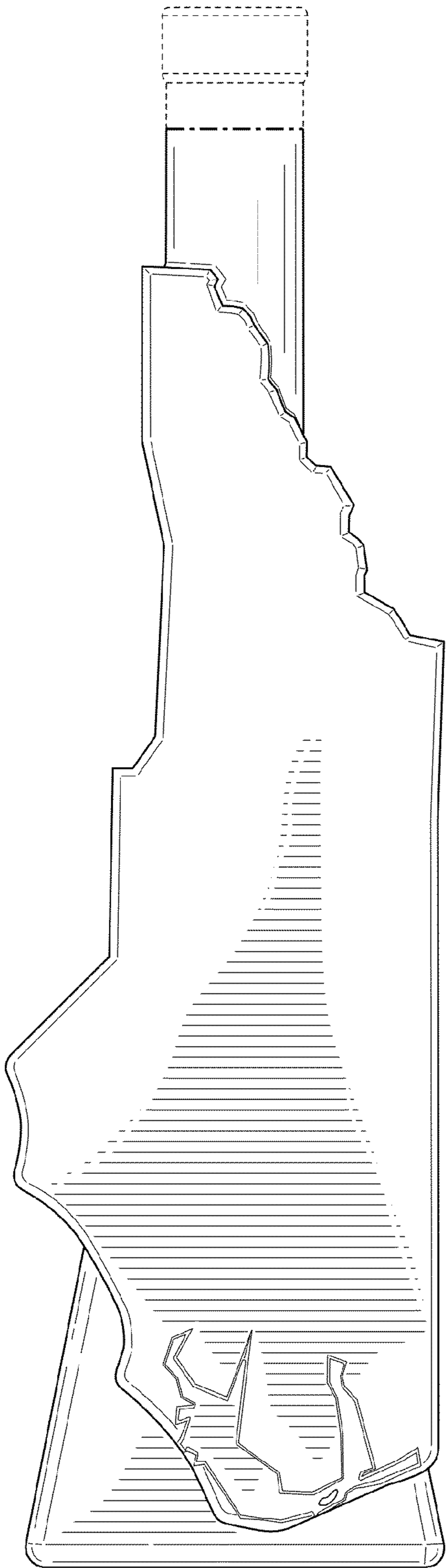

FIG. 11

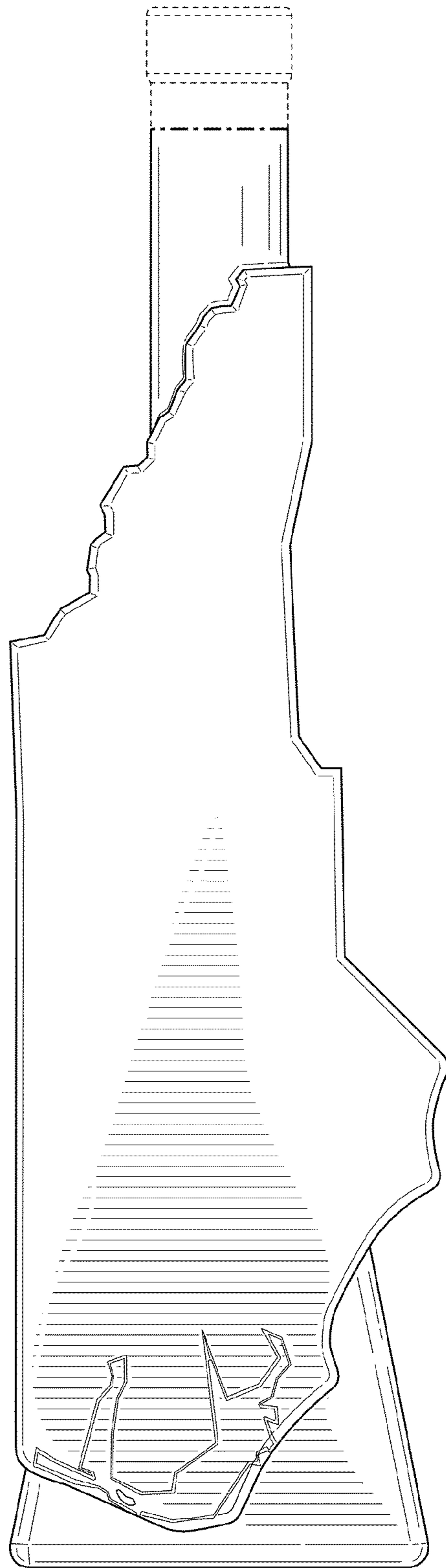

FIG. 12

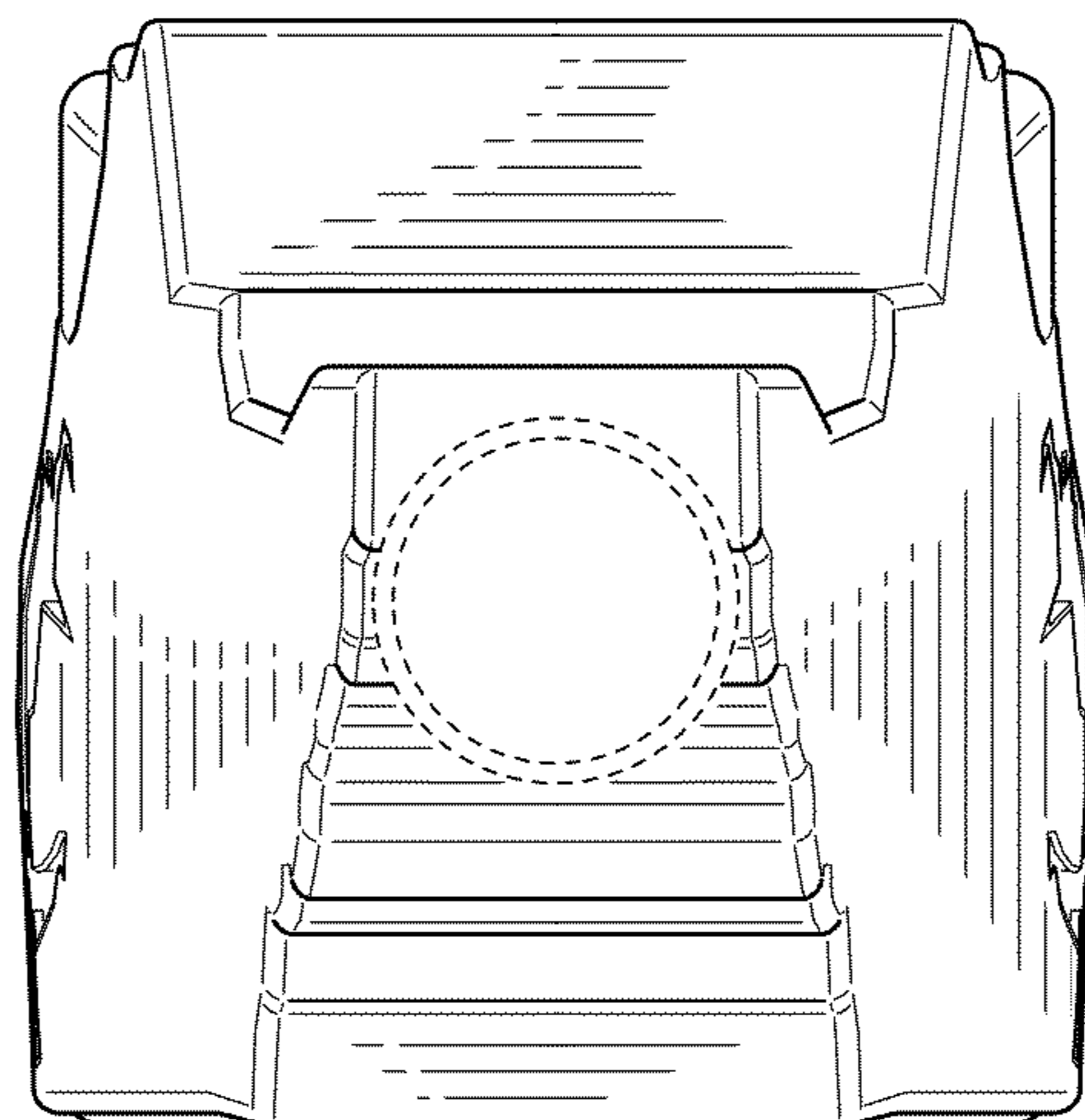

FIG. 13

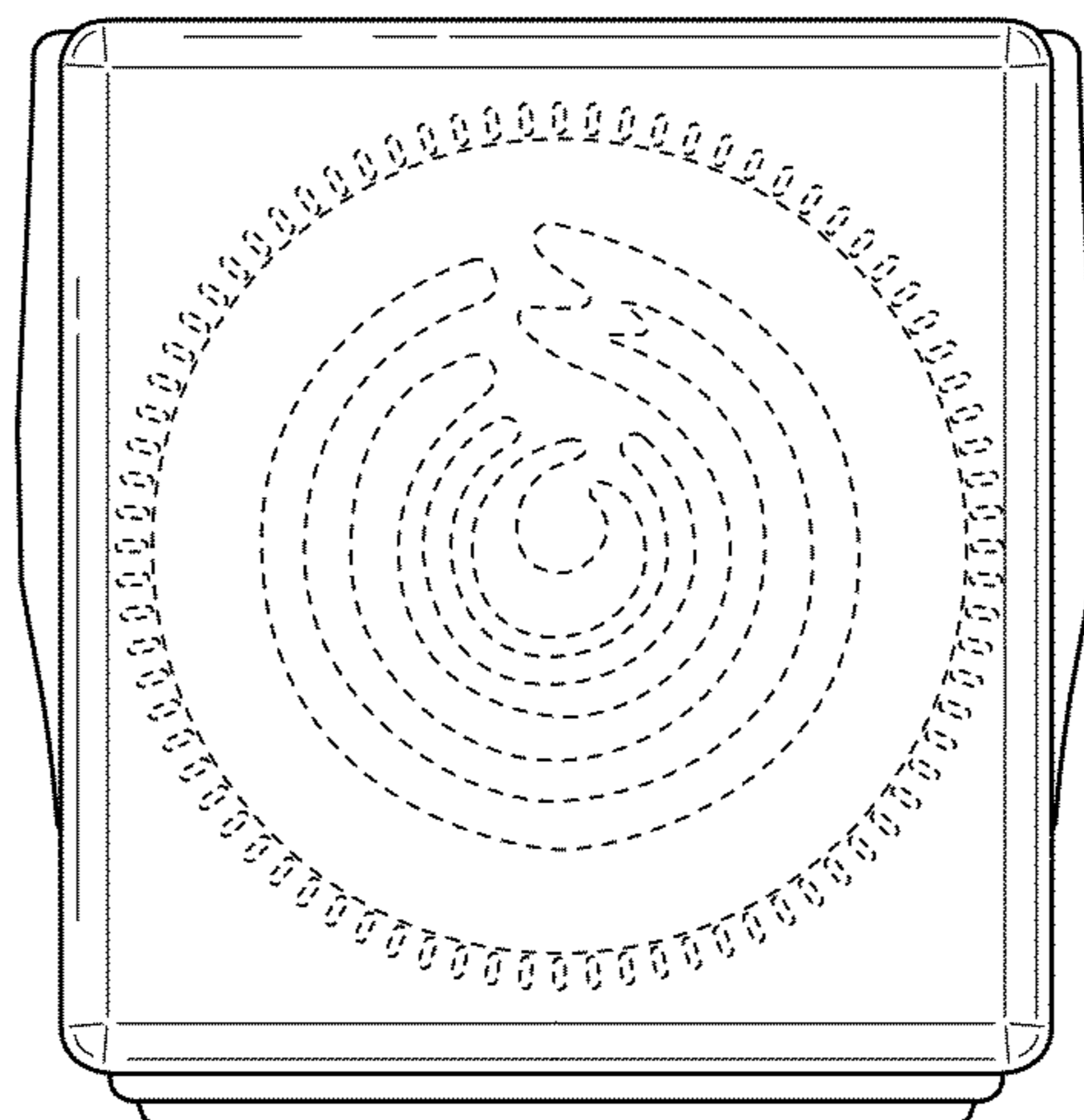

FIG. 14

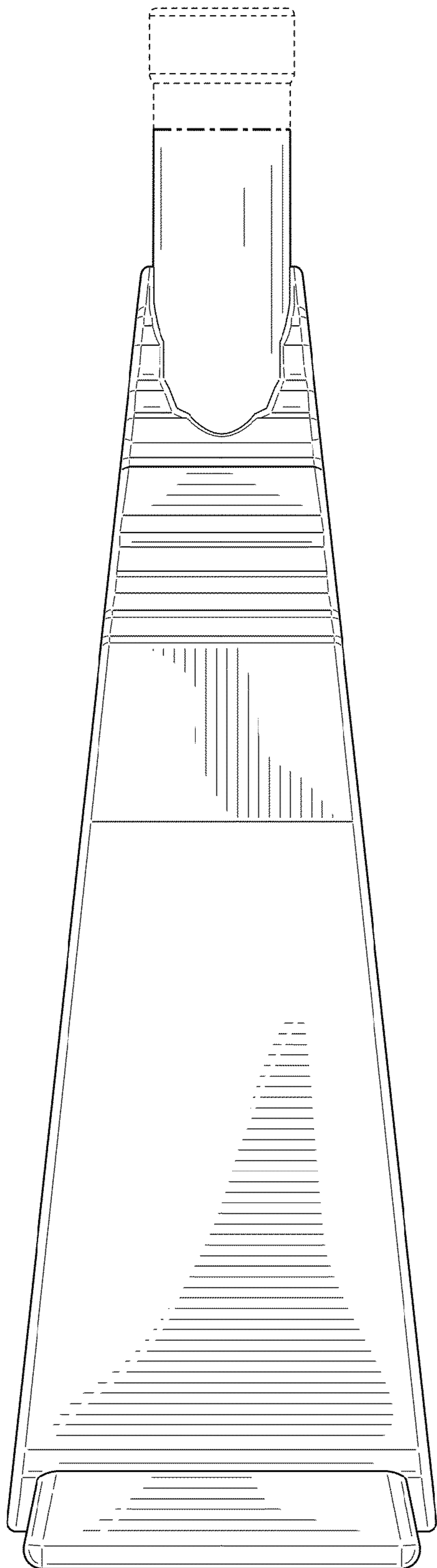

FIG. 15

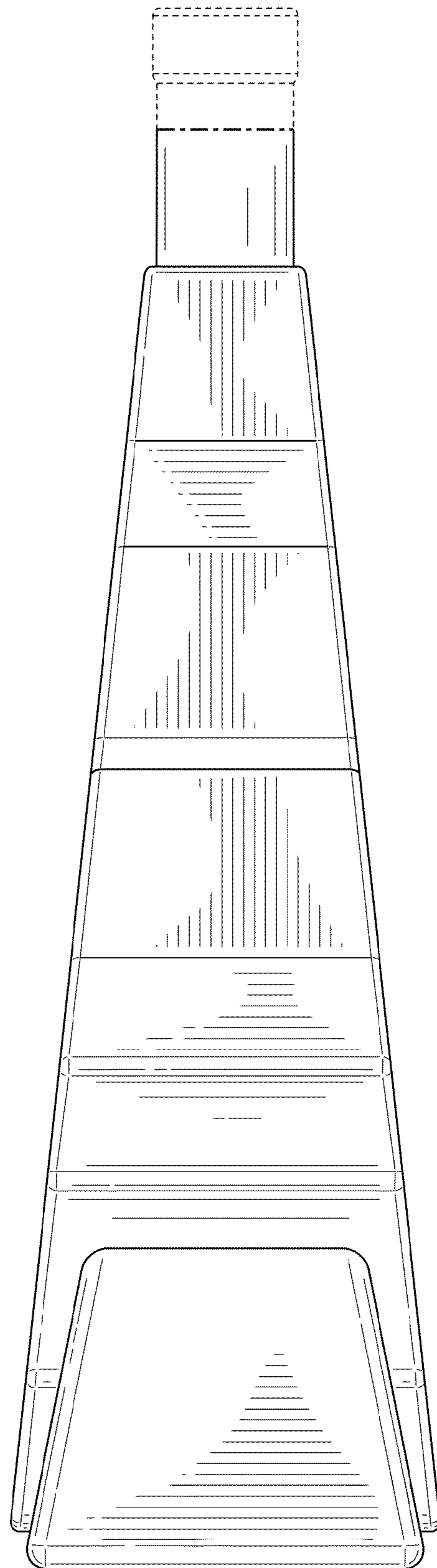

FIG. 16

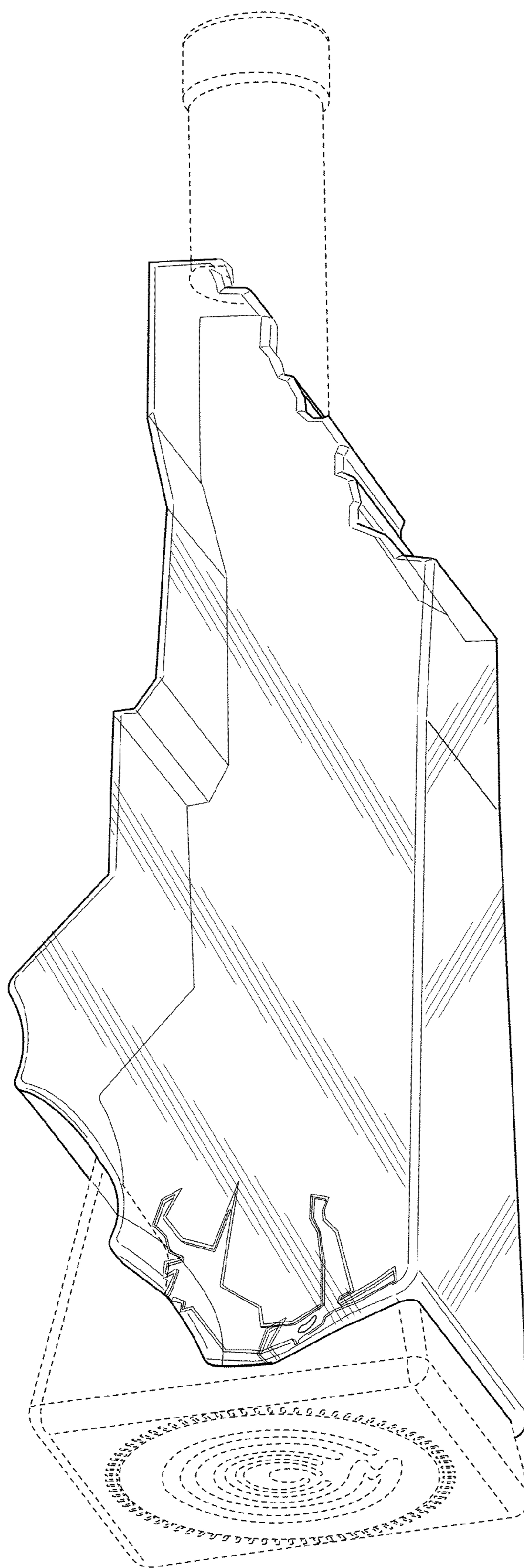

FIG. 17

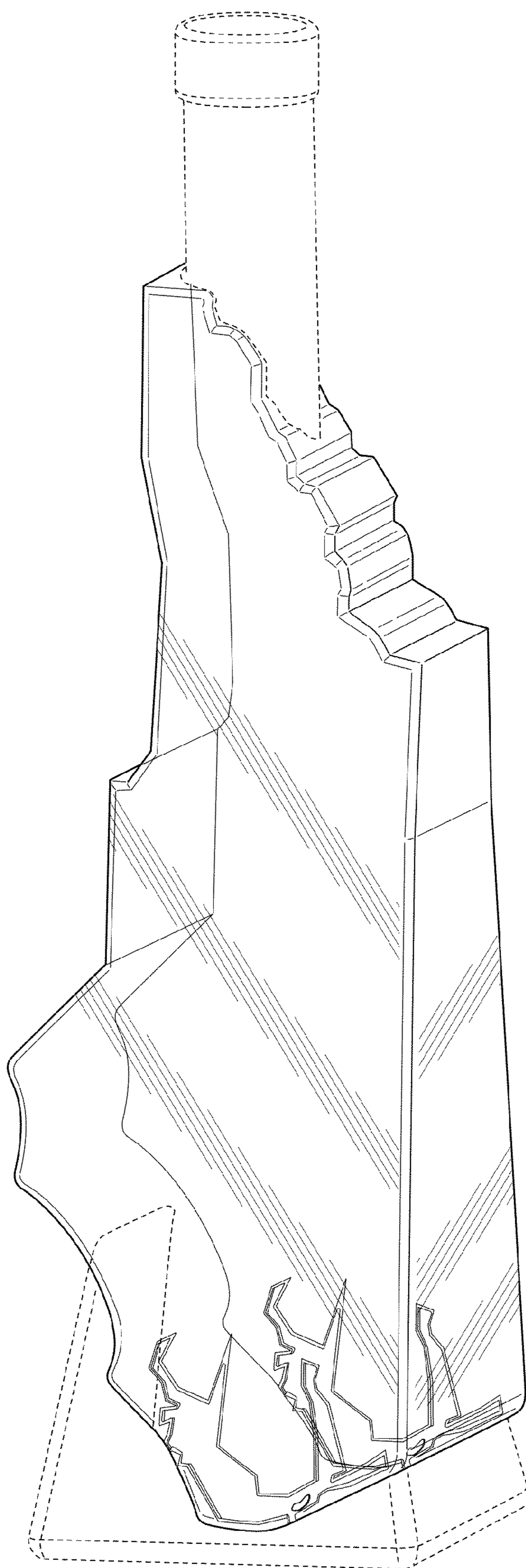

FIG. 18

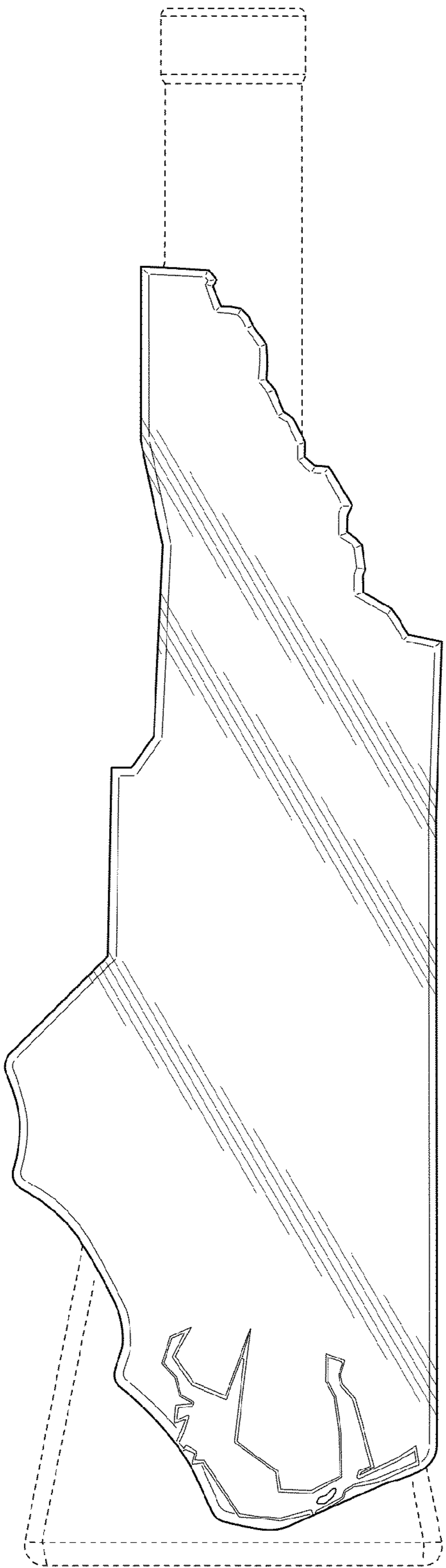

FIG. 19

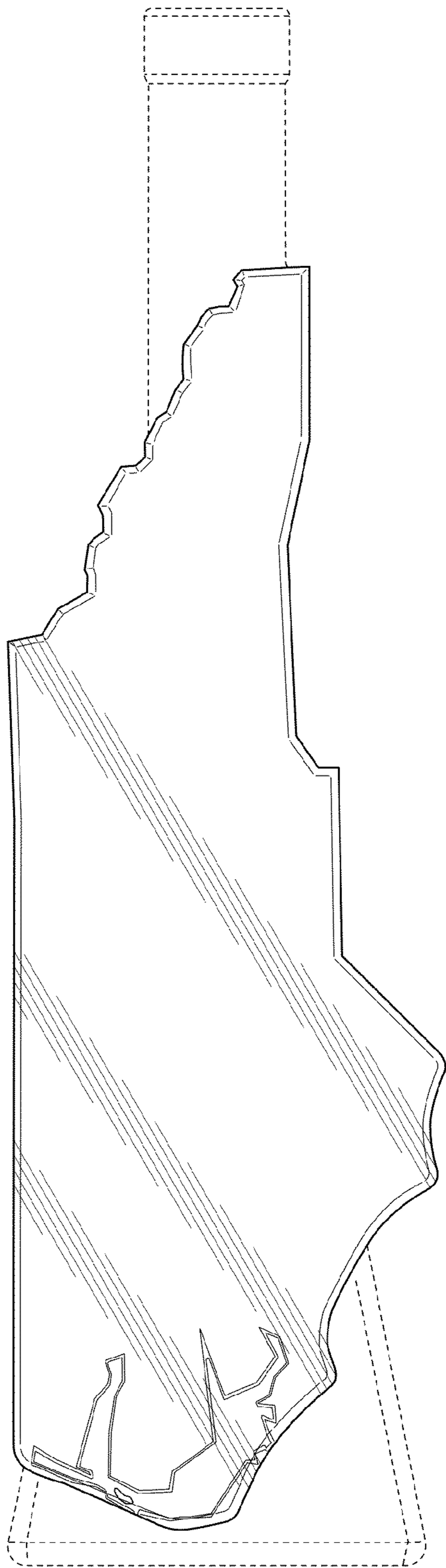

FIG. 20

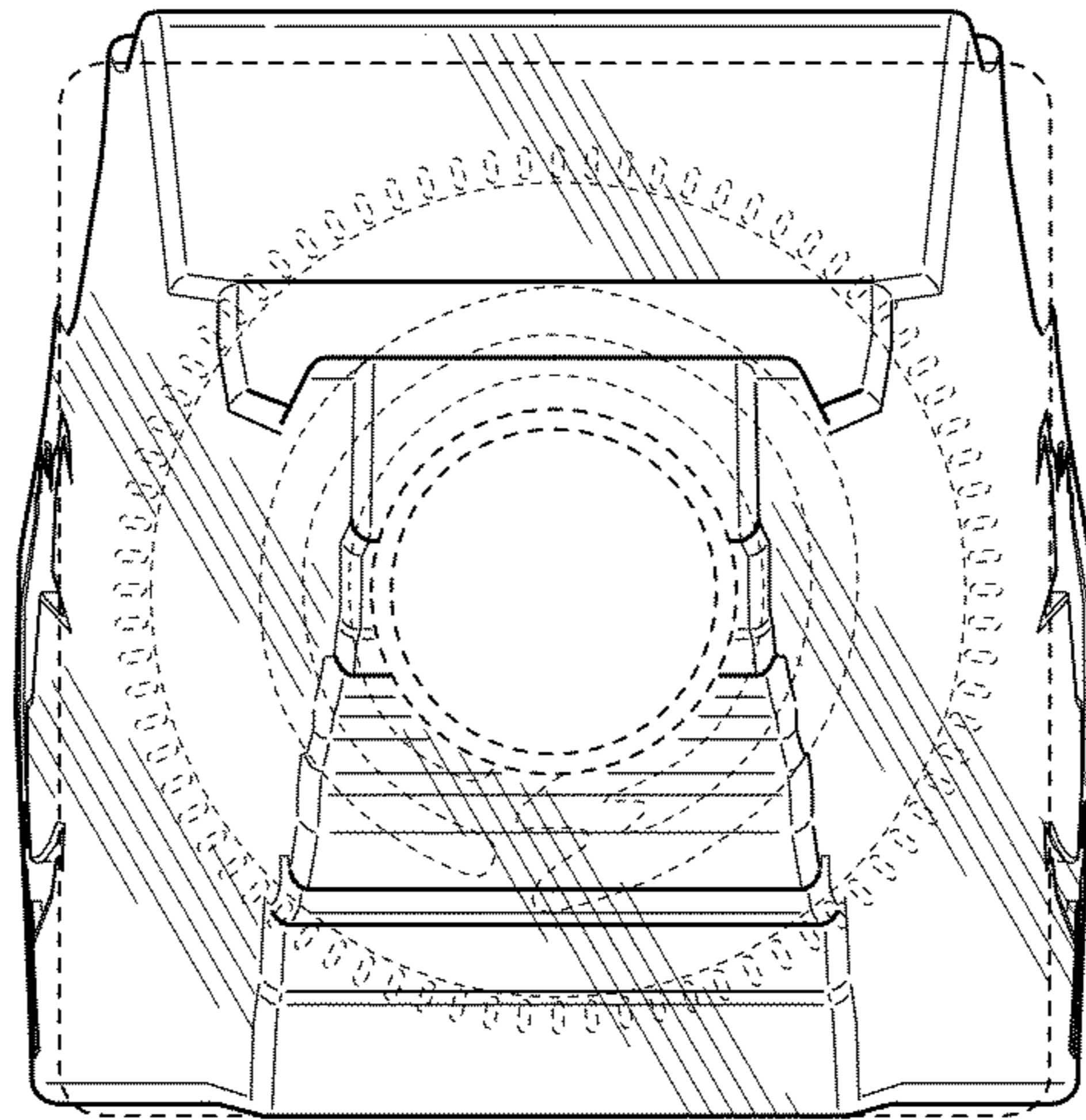

FIG. 21

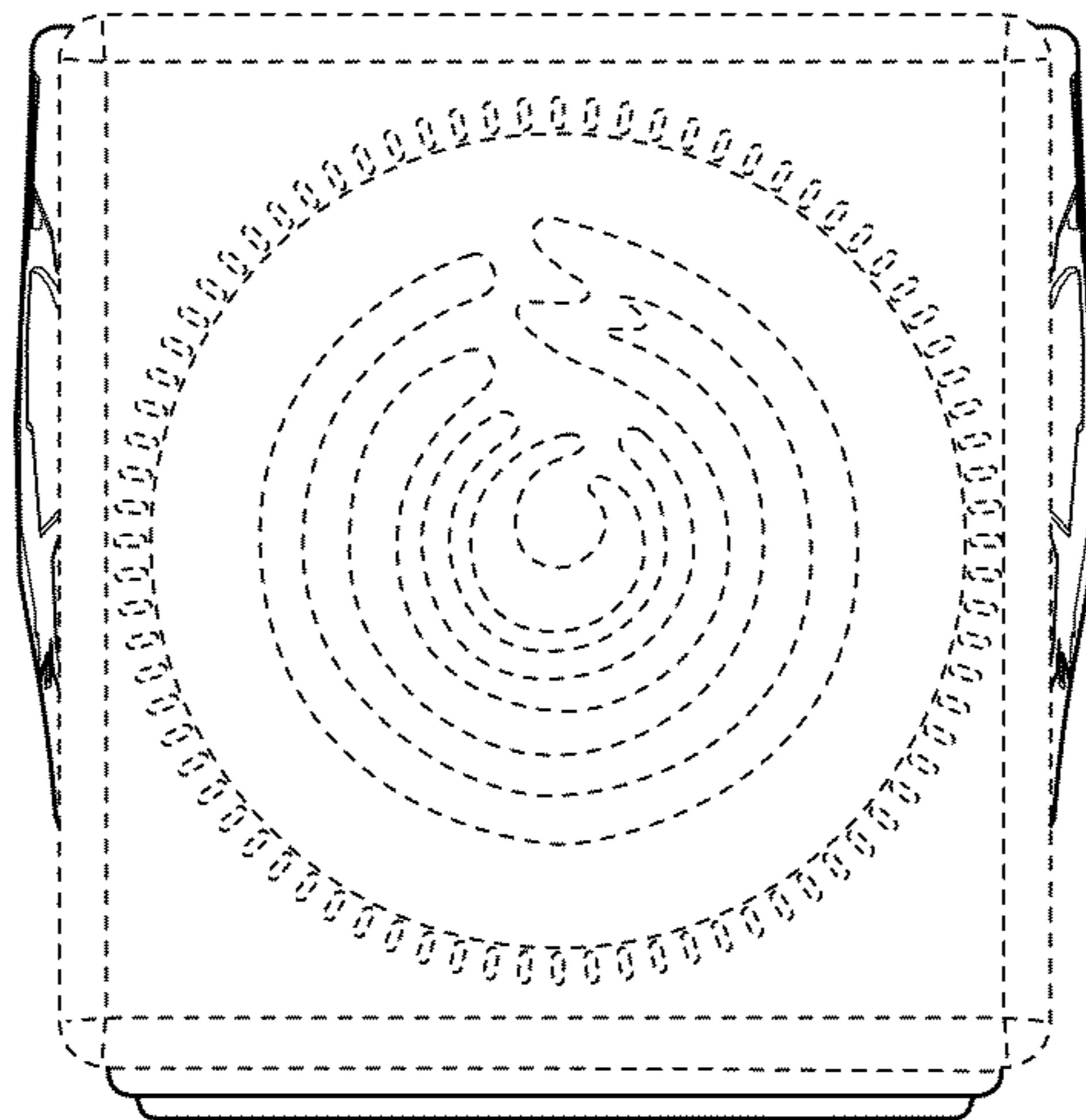

FIG. 22

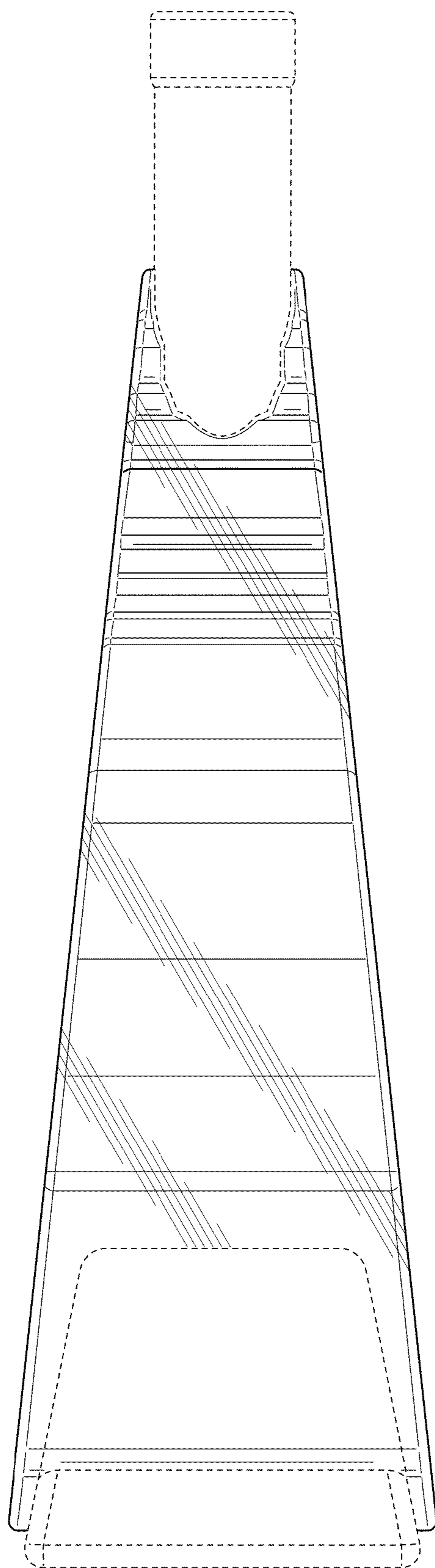

FIG. 23

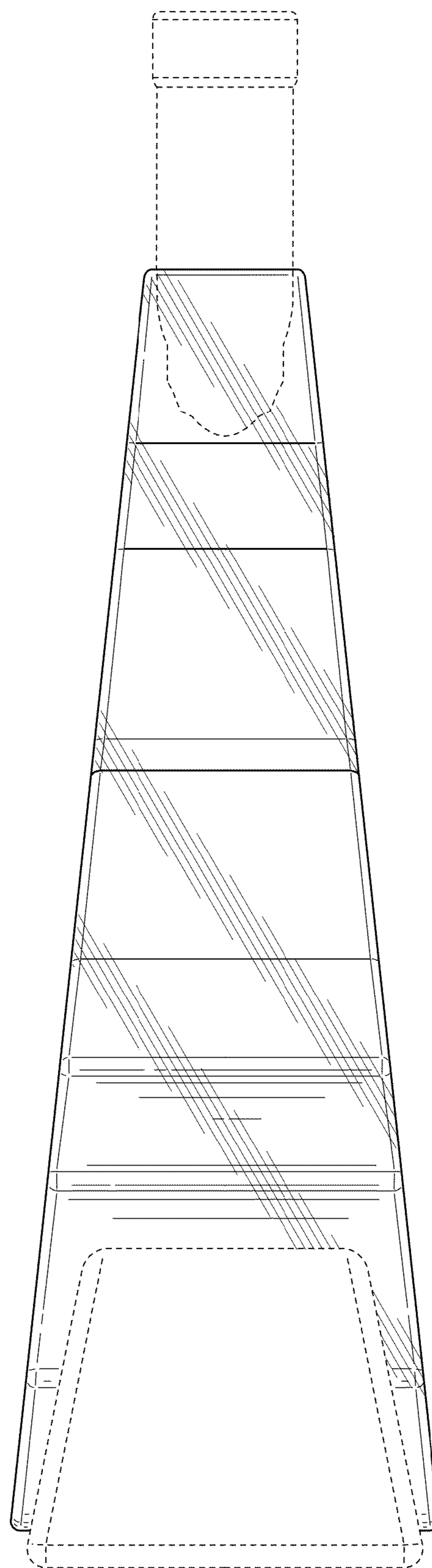

FIG. 24