



US00D713725S

(12) **United States Design Patent**
Cedeno

(10) **Patent No.:** **US D713,725 S**

(45) **Date of Patent:** **** Sep. 23, 2014**

(54) **FOOD BOX INSERT**

(71) Applicant: **Otto's Tacos, LLC**, New York, NY (US)

(72) Inventor: **Otto Cedeno**, New York, NY (US)

(73) Assignee: **Otto's Tacos, LLC**, New York, NY (US)

(**) Term: **14 Years**

(21) Appl. No.: **29/466,770**

(22) Filed: **Sep. 11, 2013**

(51) **LOC (10) Cl.** **09-07**

(52) **U.S. Cl.**

USPC **D9/456; D7/504**

(58) **Field of Classification Search**

CPC . A47G 21/001; A47G 2019/306; A47J 43/18;
A47J 37/1295; B65D 65/38; B65D 65/00

USPC D9/456, 432, 433; D7/504; D3/272,
D3/313, 318, 319; D25/153; 206/456,
206/521-594, 736-774; 426/107, 118, 124,
426/560; 229/125.08, 125.28, 120.24, 146,
229/160.1, 225; 53/387.1, 397, 449, 452,
53/458; 99/426

See application file for complete search history.

(56) **References Cited**

U.S. PATENT DOCUMENTS

D29,299	S	*	9/1898	Barkley	D9/456
D30,088	S	*	1/1899	Barkley	D9/456
2,741,362	A	*	4/1956	Cortright	206/453
3,101,166	A	*	8/1963	Van Antwerpen	206/454
D197,535	S	*	2/1964	Weiss	D9/456
D197,631	S	*	3/1964	Caprioli	D9/456
D197,632	S	*	3/1964	Caprioli	D9/456
D197,633	S	*	3/1964	Kuss	D9/456
3,761,974	A	*	10/1973	Kuss	5/679
3,982,684	A	*	9/1976	David	229/120.26
D259,010	S	*	4/1981	Klatt	D7/504

D275,256	S	*	8/1984	Gilliam	D7/504
D282,338	S	*	1/1986	Putt	D7/504
D288,273	S	*	2/1987	Gould	D7/586
D298,413	S	*	11/1988	Raudat	D9/456
4,794,005	A	*	12/1988	Swiontek	426/107
D299,405	S	*	1/1989	Bothmann	D7/686
D310,287	S	*	9/1990	Pellegrino	D1/126
D318,372	S	*	7/1991	Mackey	D3/319
5,034,234	A	*	7/1991	Andreas et al.	426/107
D319,372	S	*	8/1991	Cobb	D7/504
5,084,601	A	*	1/1992	Andreas et al.	219/730
5,096,723	A	*	3/1992	Turpin	426/107
D327,433	S	*	6/1992	Sewell	D9/456
D330,333	S	*	10/1992	Williams	D9/456
5,153,402	A	*	10/1992	Quick et al.	219/730
D350,692	S	*	9/1994	Seki	D9/636

(Continued)

Primary Examiner — Susan Bennett Hattan

Assistant Examiner — Marie Fast Horse

(74) *Attorney, Agent, or Firm* — Venable, Campillo, Logan & Meaney P.C.

(57) **CLAIM**

The ornamental design for a food box insert, as shown and described.

DESCRIPTION

FIG. 1 is a bottom perspective view of a food box insert;
FIG. 2 is a first end view thereof;
FIG. 3 is a second end view thereof;
FIG. 4 is a first side view thereof;
FIG. 5 is a second side view thereof;
FIG. 6 is a bottom view thereof;
FIG. 7 is a top view thereof; and,
FIG. 8 is a top perspective view of the insert in a non-claimed food box thereof.

The broken lines in the drawings depict environmental subject matter only and form no part of the claimed design.

1 Claim, 6 Drawing Sheets

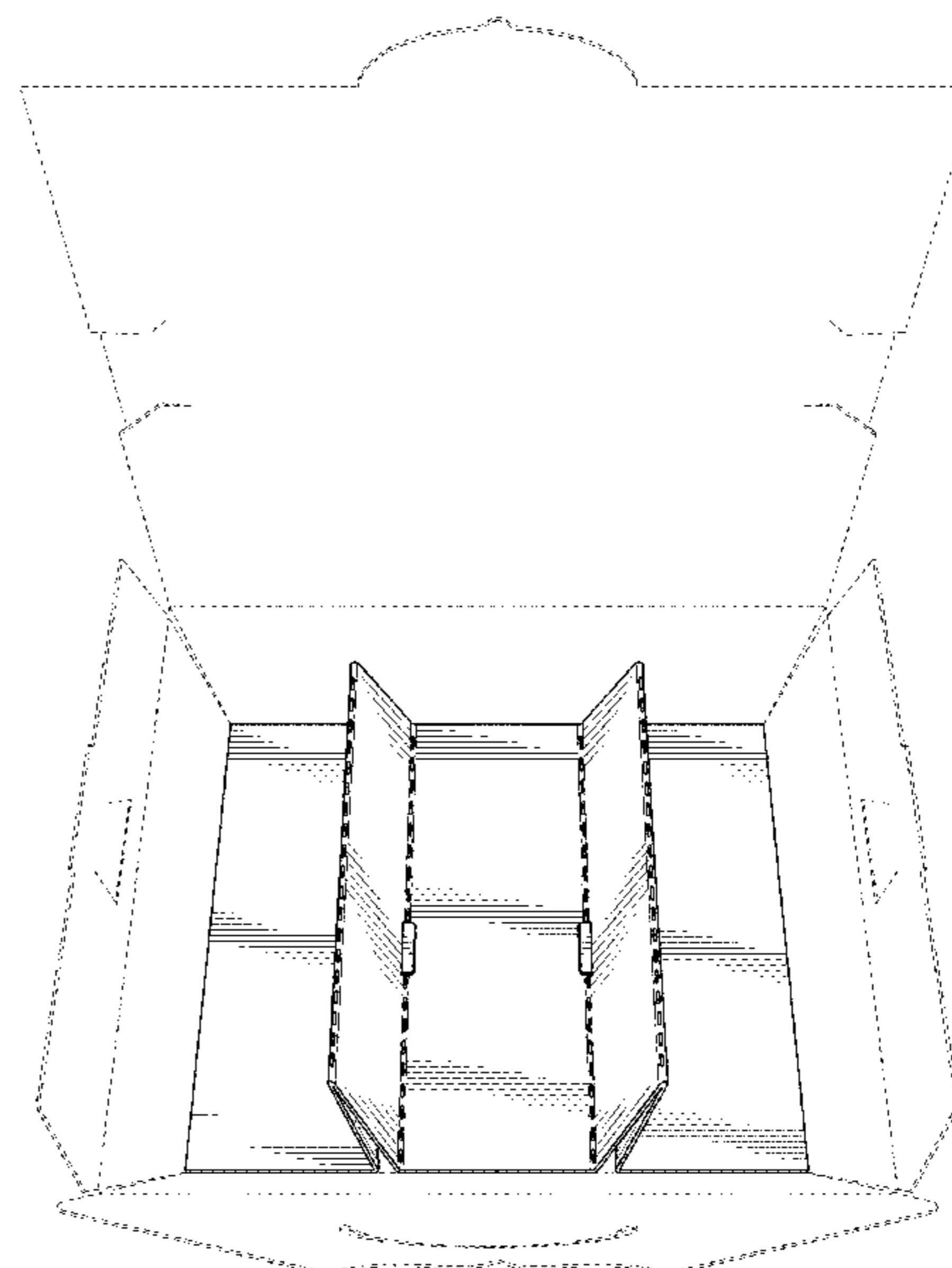
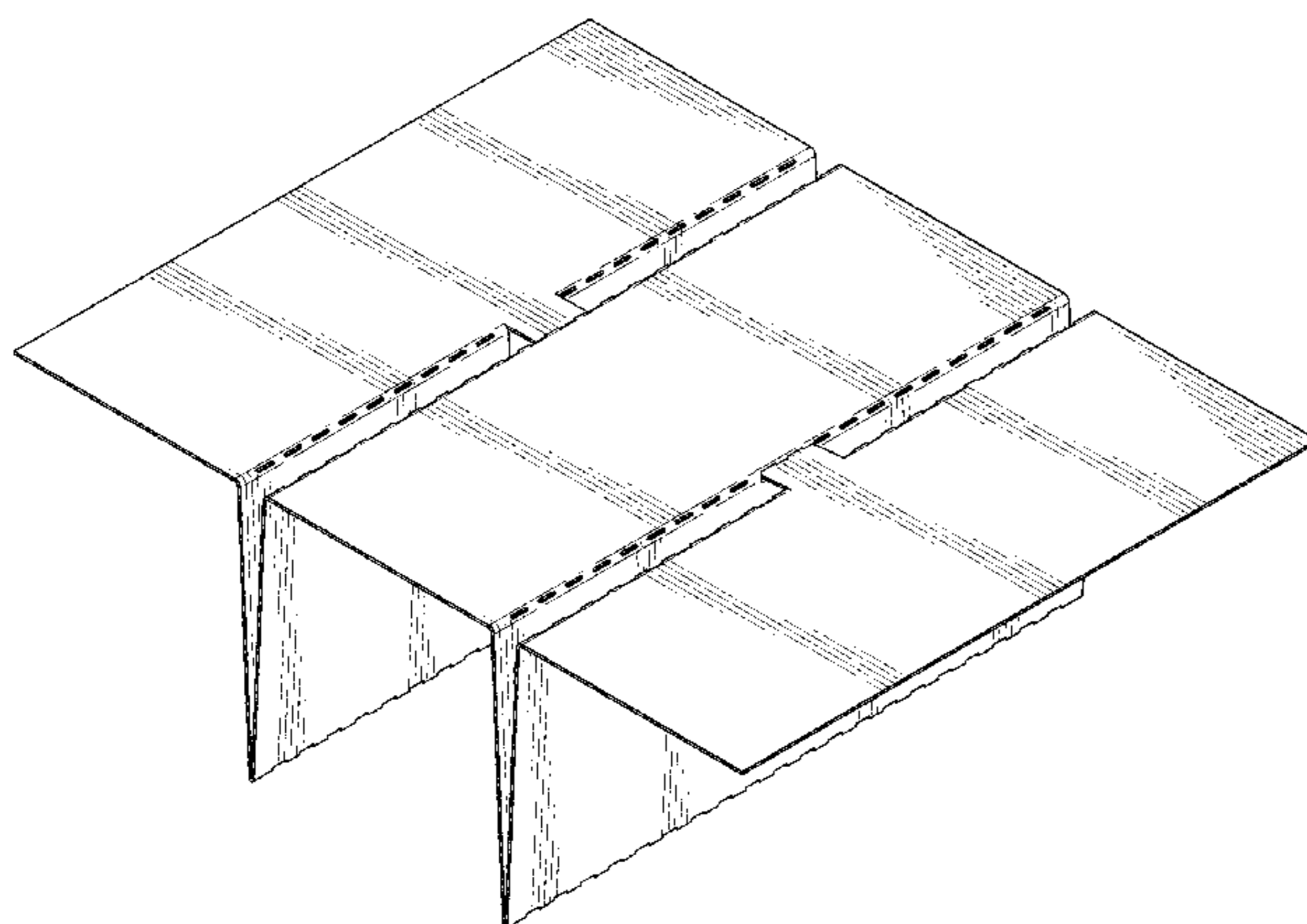

(56)

References Cited

U.S. PATENT DOCUMENTS

D358,095 S *	5/1995	Weimer	D9/456	D663,329 S *	7/2012	Hammer	D15/136
D358,096 S *	5/1995	Weimer	D9/456	D666,100 S *	8/2012	Fallon	D9/456
5,487,504 A *	1/1996	Baird	229/120.17	8,292,082 B2 *	10/2012	Bowman	206/764
D411,413 S *	6/1999	Pfingsten	D7/504	D673,853 S *	1/2013	Burns et al.	D9/456
5,950,911 A *	9/1999	Naughton et al.	229/109	D675,065 S *	1/2013	Tarantino et al.	D7/601
D421,212 S *	2/2000	Dunn	D8/356	D676,070 S *	2/2013	Hammer	D15/136
D483,666 S *	12/2003	Juma et al.	D9/433	D679,300 S *	4/2013	Hammer	D15/136
6,781,101 B1 *	8/2004	Hoese et al.	219/730	2004/0163992 A1 *	8/2004	Muis et al.	206/564
7,000,773 B2 *	2/2006	Hubbs et al.	206/764	2006/0151585 A1 *	7/2006	Misjak	229/120.24
D523,610 S *	6/2006	Kissell	D34/38	2006/0283925 A1 *	12/2006	Specker	229/120.24
7,320,407 B2 *	1/2008	Hubbs et al.	206/764	2007/0163449 A1 *	7/2007	Hart	99/426
7,565,864 B2 *	7/2009	Hart	99/426	2008/0286431 A1 *	11/2008	Brown	426/560
					2009/0223857 A1 *	9/2009	Bowman	206/756
					2011/0274880 A1 *	11/2011	Gotschi	428/156
					2013/0105353 A1 *	5/2013	D'Amico	206/559

* cited by examiner

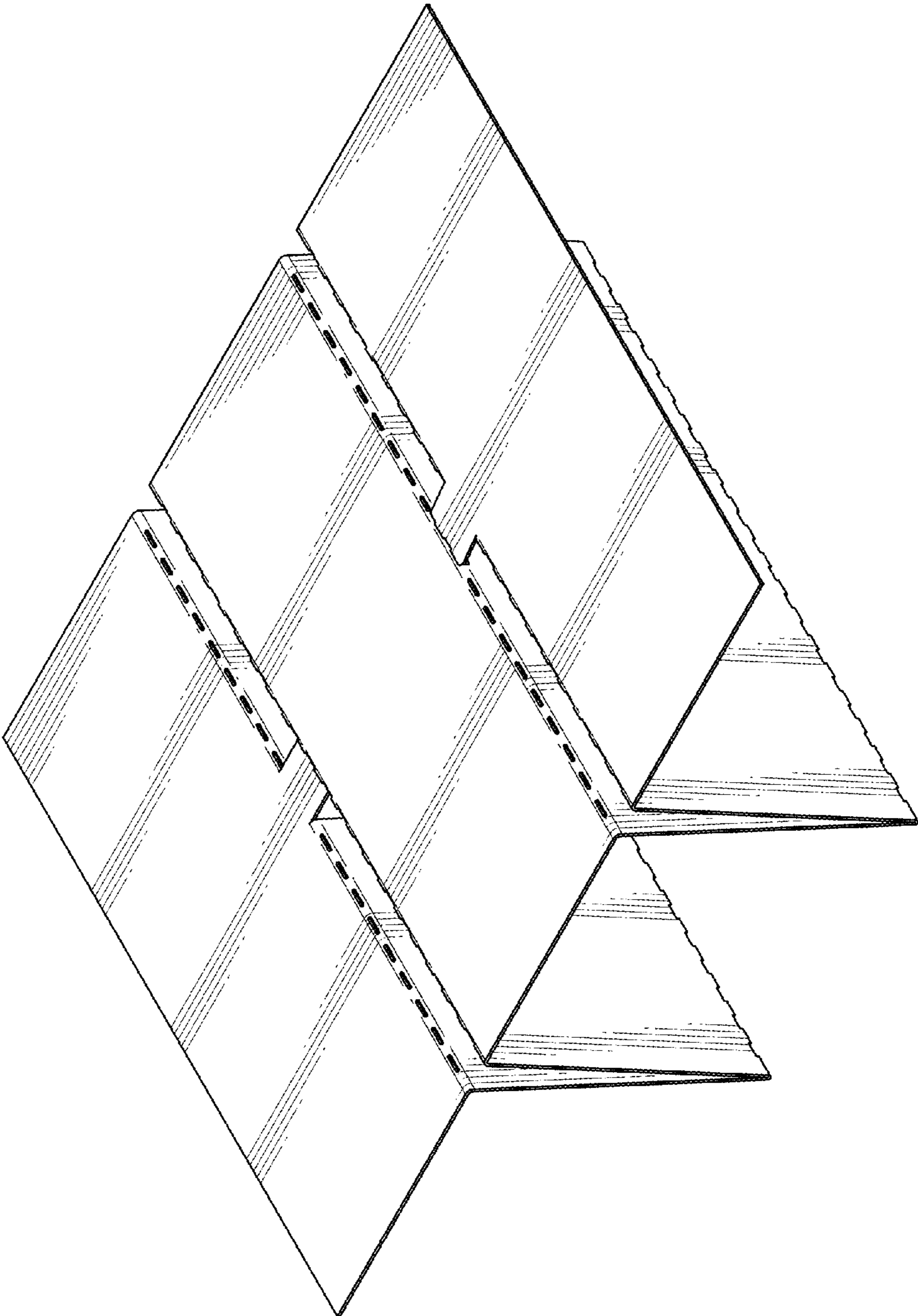

FIG. 1

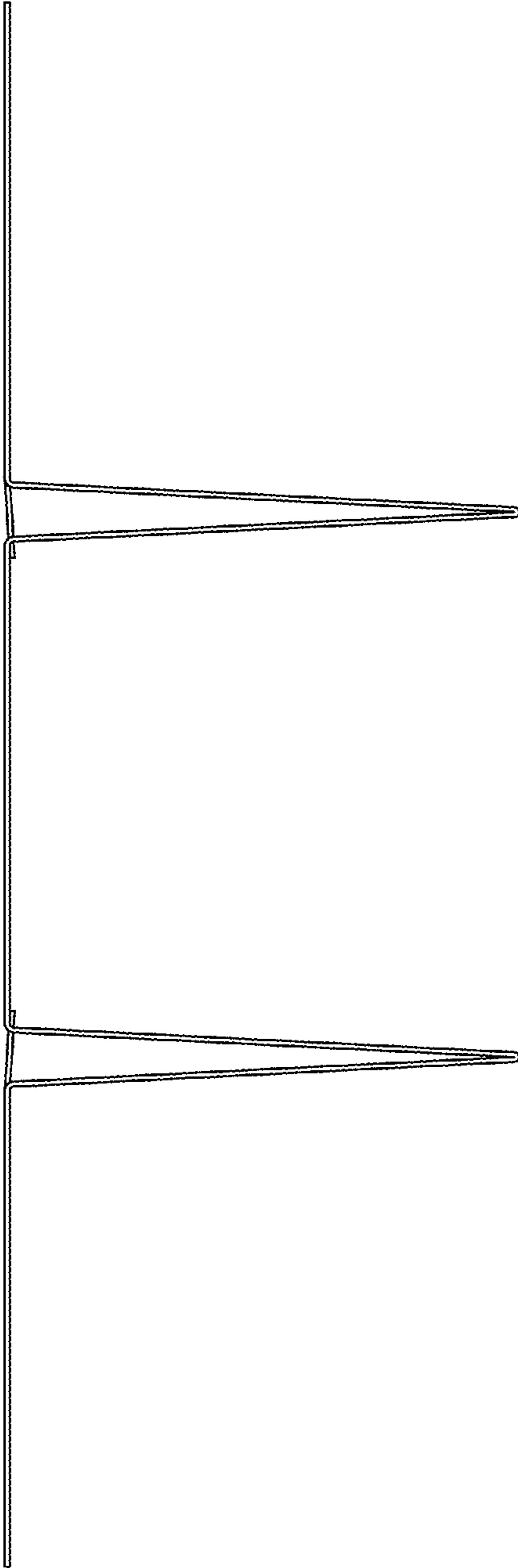

FIG. 2

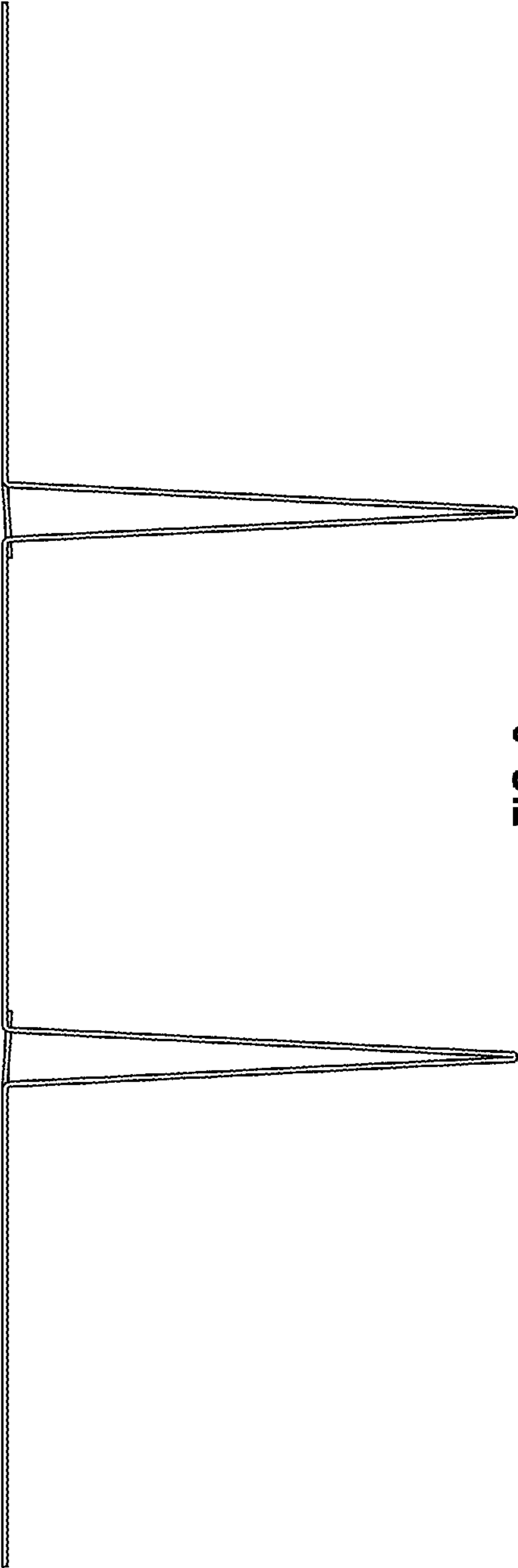

FIG. 3

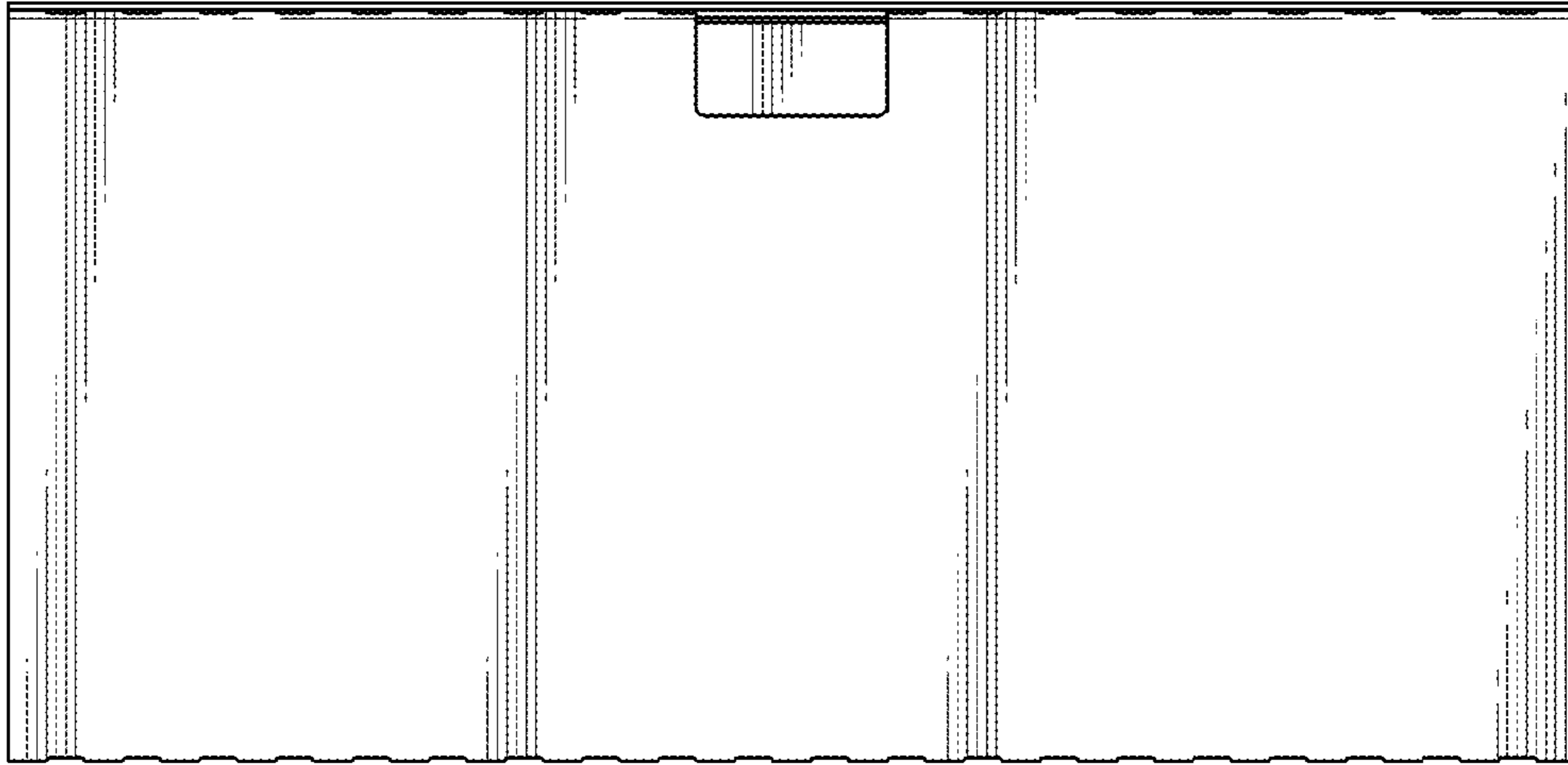

FIG. 4

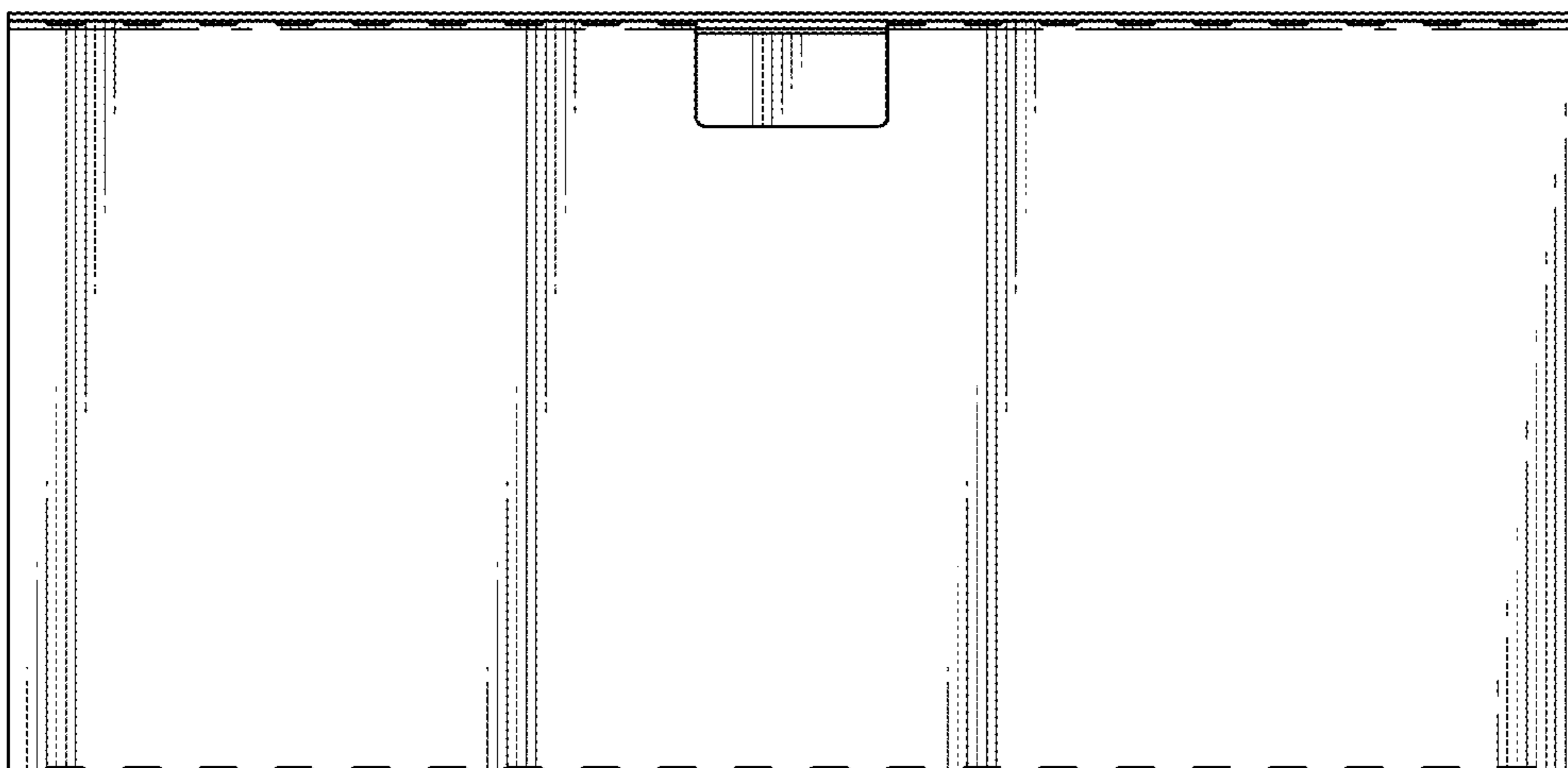

FIG. 5

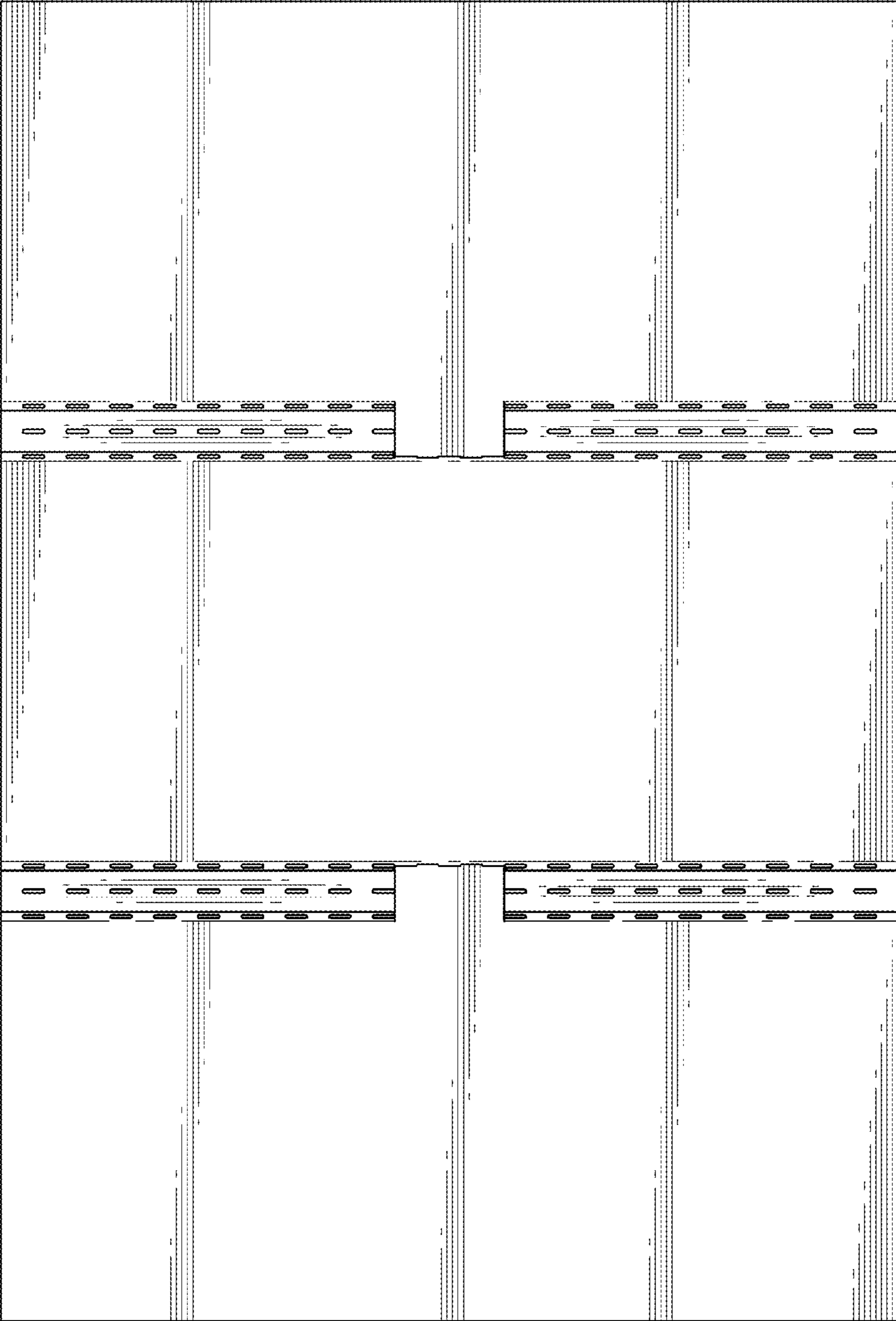

FIG. 6

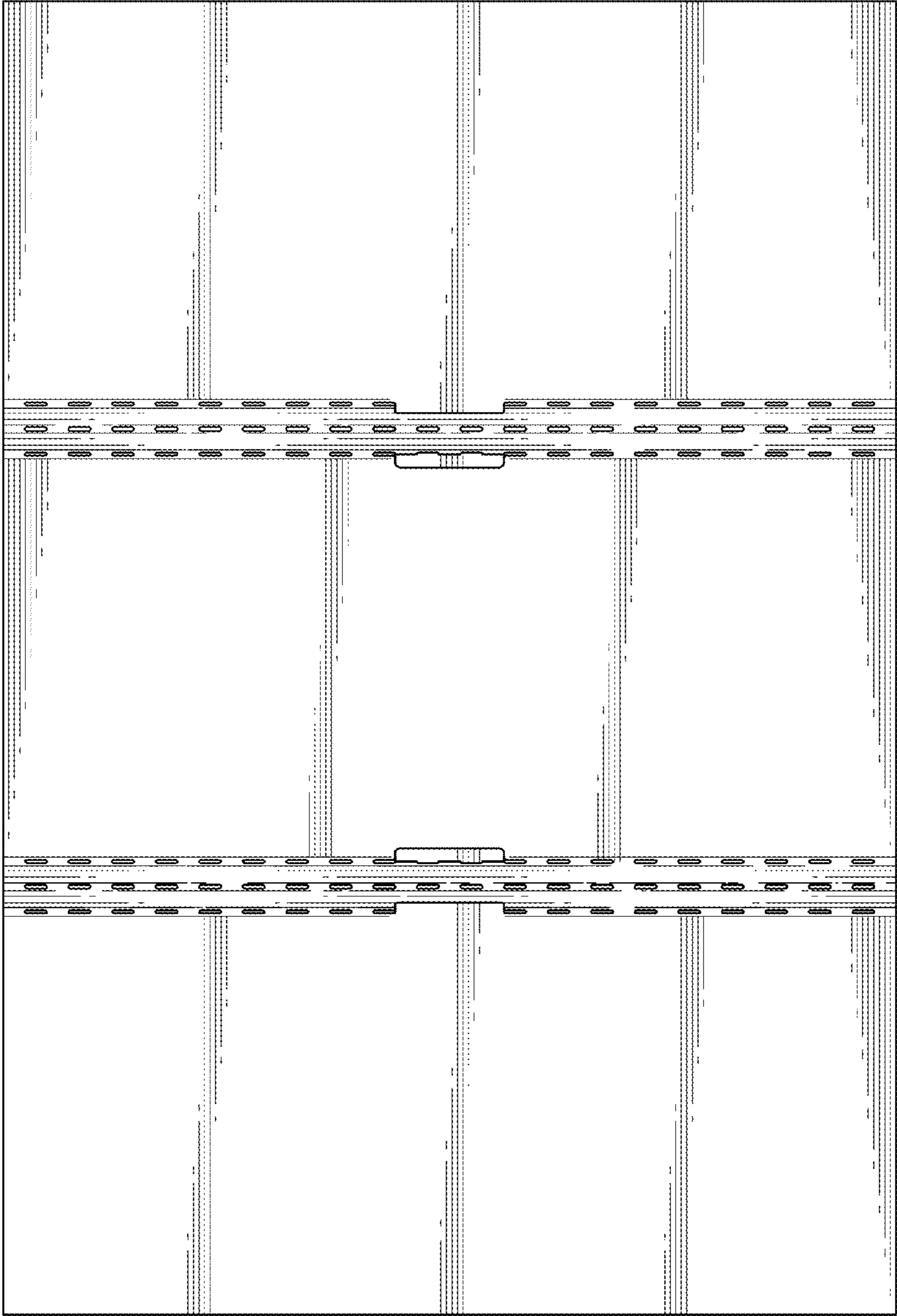

FIG. 7

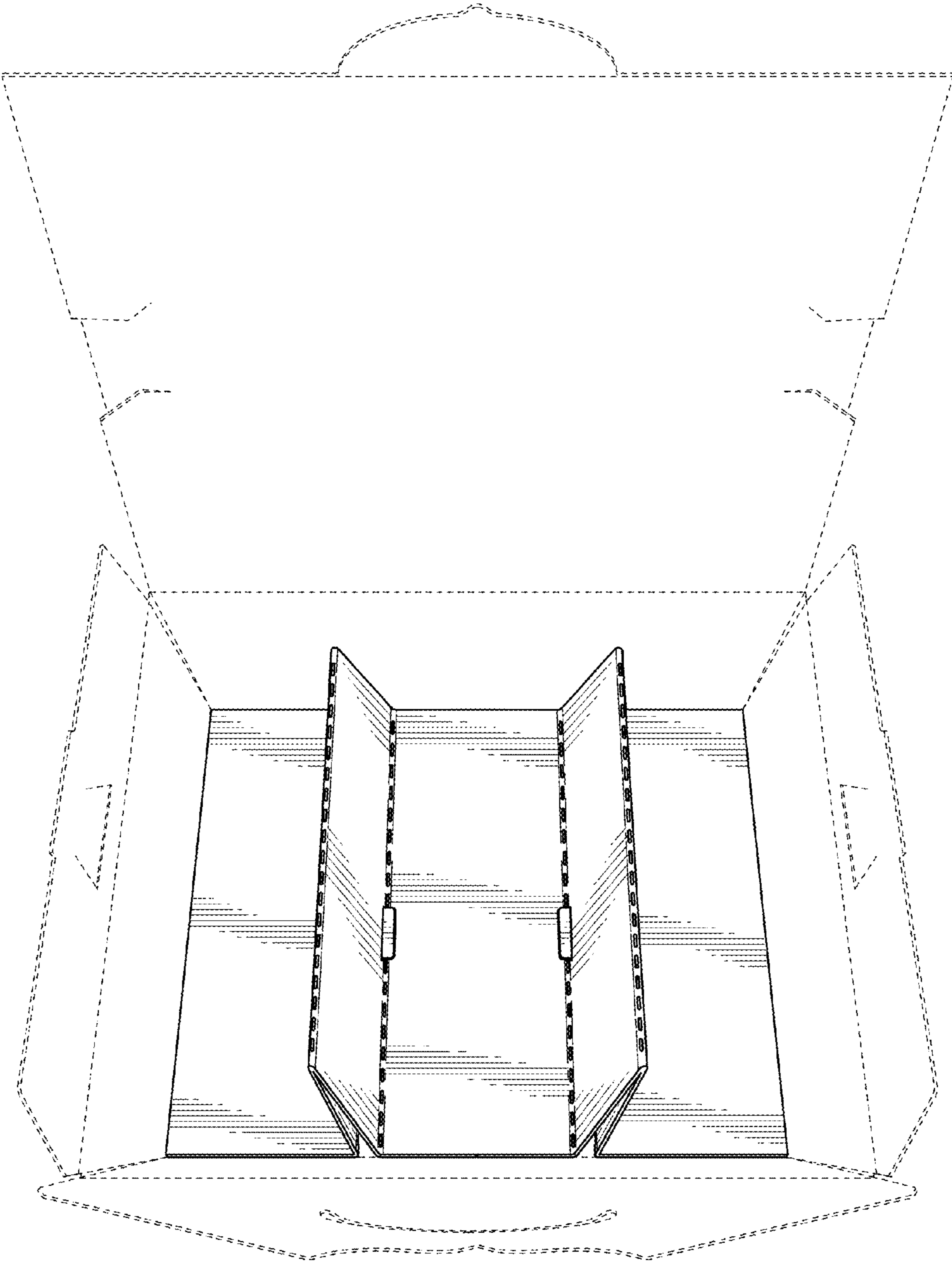

FIG. 8