



US00D713675S

(12) **United States Design Patent**
Rae

(10) **Patent No.:** **US D713,675 S**

(45) **Date of Patent:** **** Sep. 23, 2014**

(54) **SIDE HANDLE FOR COOKWARE**

(71) Applicant: **Meyer Intellectual Properties Ltd.**,
Kowloon (HK)

(72) Inventor: **Robert A. Rae**, Las Vegas, NV (US)

(73) Assignee: **Meyer Intellectual Properties Limited**
(VG)

(**) Term: **14 Years**

(21) Appl. No.: **29/460,277**

(22) Filed: **Jul. 9, 2013**

(51) **LOC (10) Cl.** **07-02**

(52) **U.S. Cl.**
USPC **D7/394**

(58) **Field of Classification Search**

USPC D7/354-361, 391, 393-395, 396.2, 514,
D7/664; D8/107, 300, 301, 306, 315, 316,
D8/317, 319, 320, 321; 16/430, 431,
16/110.1, 114.1, 407, 416, 429, 443, 441;
220/377, 573.1-573.5, 752, 753, 755,
220/756, 760, 772, 773, 912; D3/318;
138/121, 145, 173

See application file for complete search history.

(56) **References Cited**

U.S. PATENT DOCUMENTS

D477,180 S *	7/2003	Burton et al.	D7/394
D482,234 S *	11/2003	Rae	D7/394
D630,052 S *	1/2011	Rae	D7/394
D642,013 S *	7/2011	Rae	D7/394
D642,429 S *	8/2011	Rae	D7/394
D644,870 S *	9/2011	Rae	D7/394
D657,995 S *	4/2012	Rae	D7/394
D657,998 S *	4/2012	Rae	D7/394
D658,435 S *	5/2012	Rae	D7/394
D663,996 S *	7/2012	Lee et al.	D7/394

* cited by examiner

Primary Examiner — Cynthia M Chin

(74) *Attorney, Agent, or Firm* — Edward S. Sherman

(57) **CLAIM**

The ornamental design for a side handle for cookware, as shown and described.

DESCRIPTION

FIG. 1 is a perspective view of a first embodiment of the side handle for cookware showing my new design; FIG. 2 is a right side elevation view thereof; the left side elevation view being the mirror image thereof; FIG. 3 is a top plan view thereof; FIG. 4 is a bottom plan view thereof; FIG. 5 is a front elevation view thereof; FIG. 6 is a rear elevation view thereof; FIG. 7 is a perspective view of a second embodiment of my new design; FIG. 8 is a right side elevation view thereof; the left side elevation view being the mirror image thereof; FIG. 9 is a top plan view thereof; FIG. 10 is a bottom plan view thereof; FIG. 11 is a front elevation view thereof; and, FIG. 12 is a rear elevation view thereof.

The broken lines in FIGS. 1, 2, 5, 6, 7, 8, 11 and 12 are for illustrative purposes only, depicting the environment of the new design, forming no part thereof as claimed.

The shading of the grip portion of the first embodiment in FIGS. 1-6 represents a contrasting surface appearance and is not intended to represent color.

The surface curvature in the second embodiment is the same as the first embodiment. The first embodiment has a grip portion with a contrasting surface appearance as illustrated by the use of shading.

1 Claim, 6 Drawing Sheets

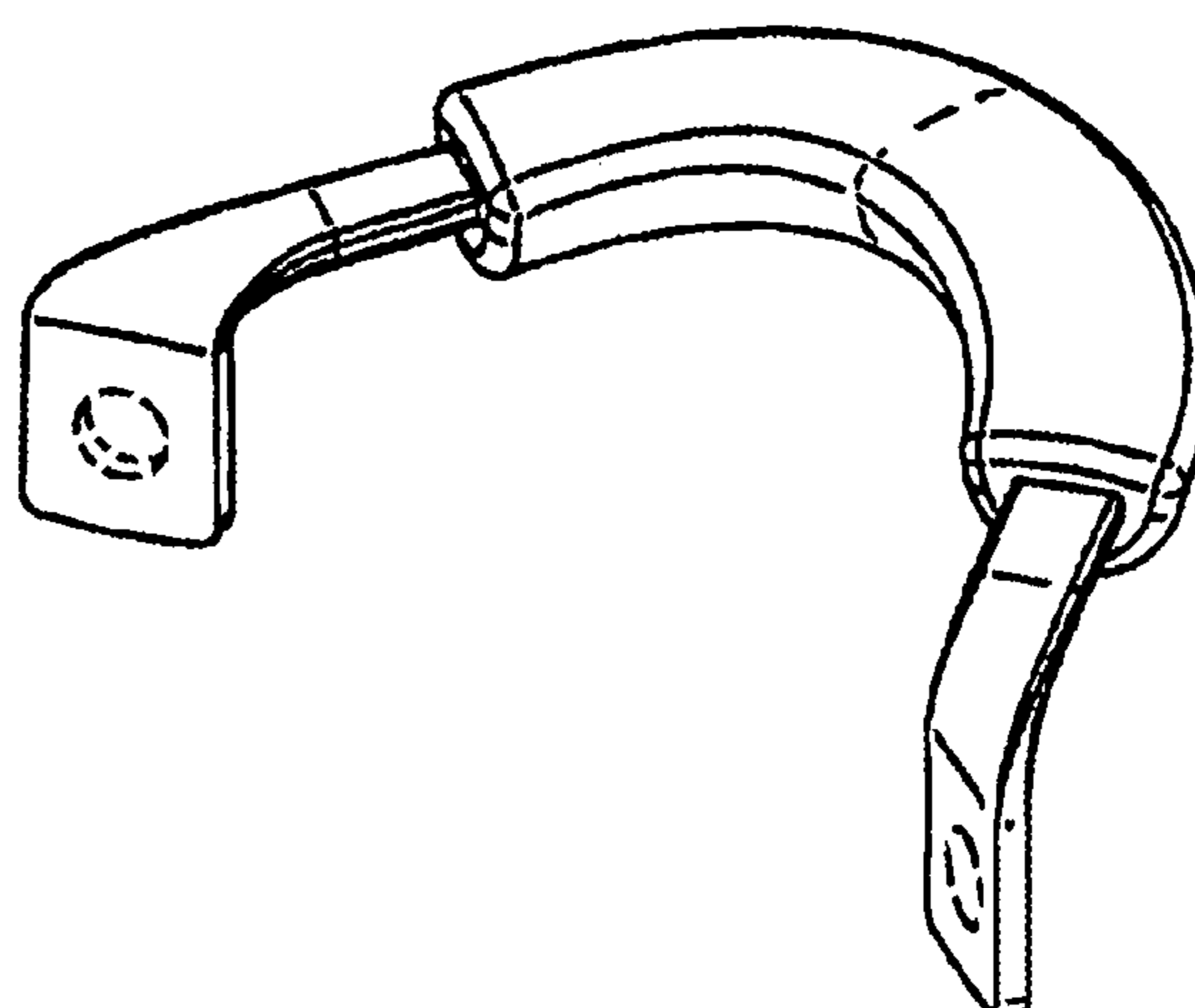
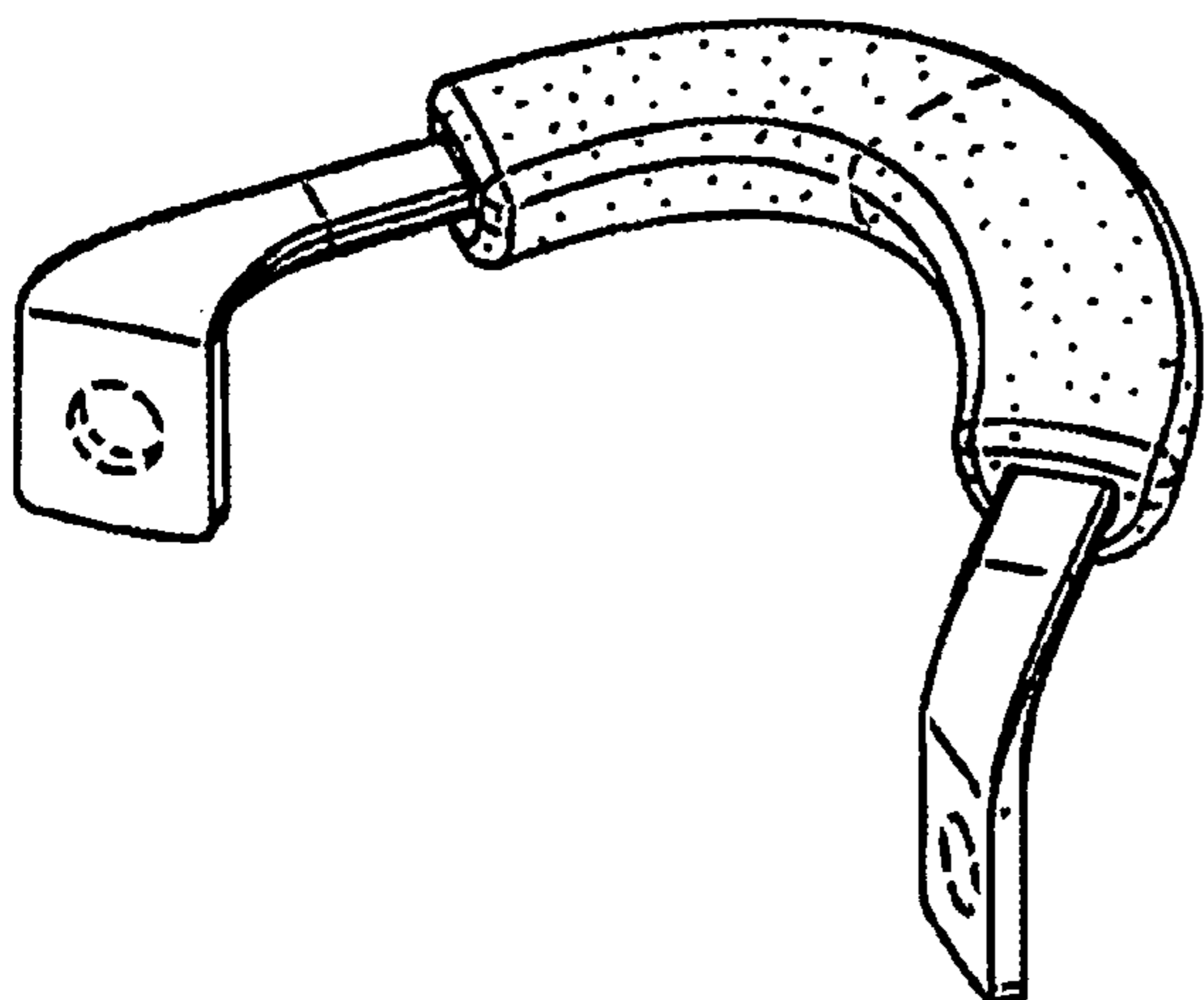

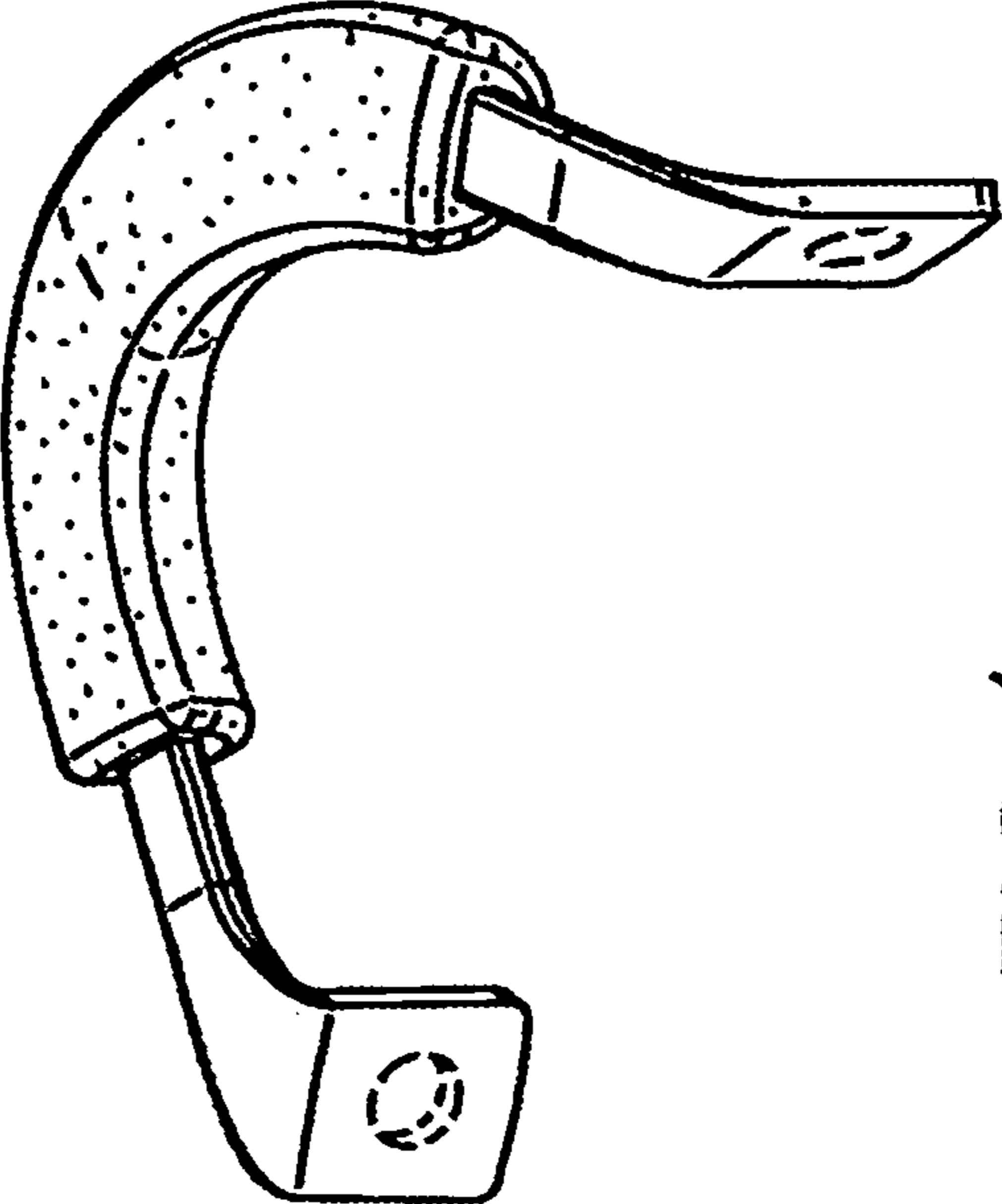

FIG. 1

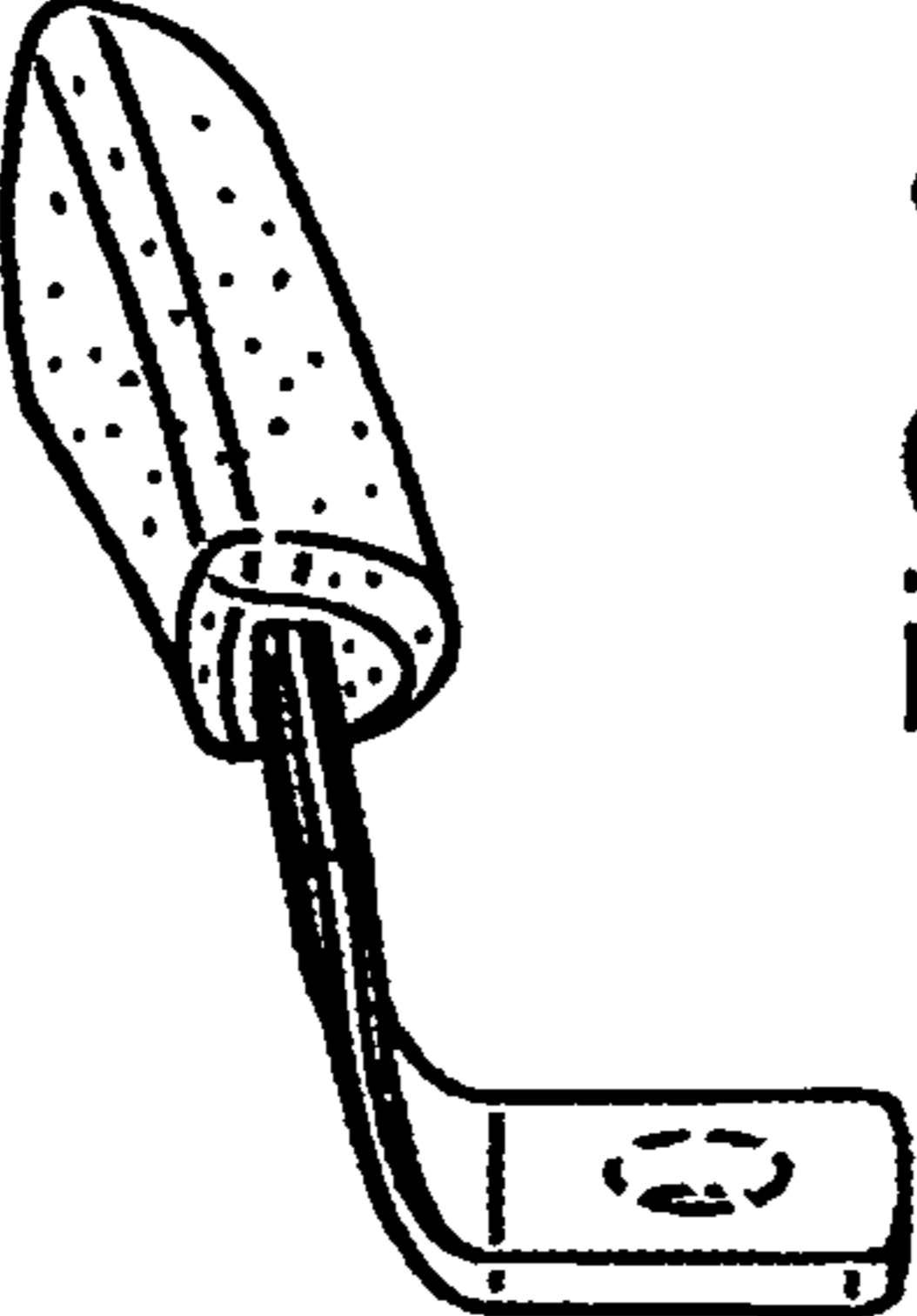

FIG. 2

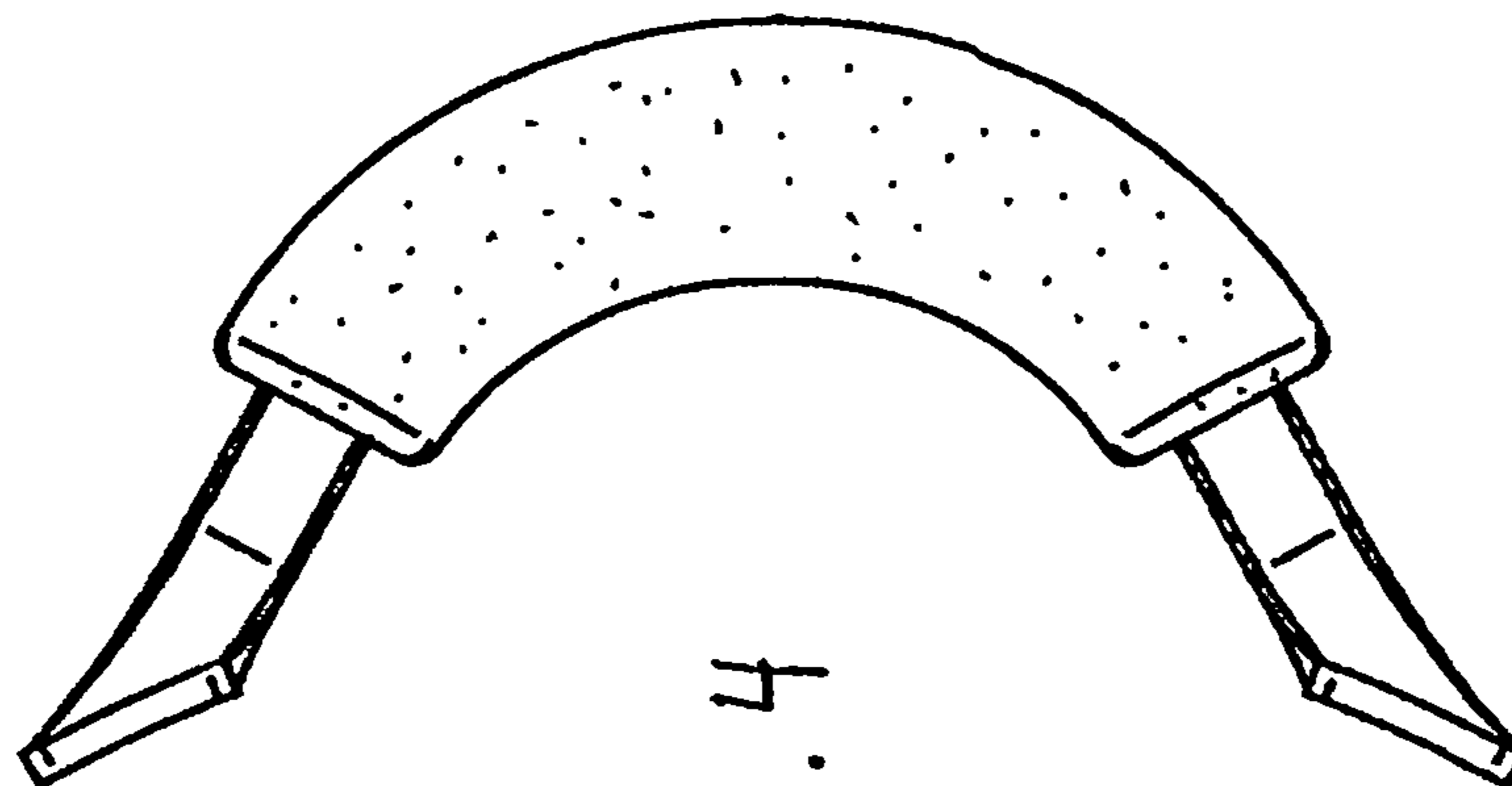

FIG. 4

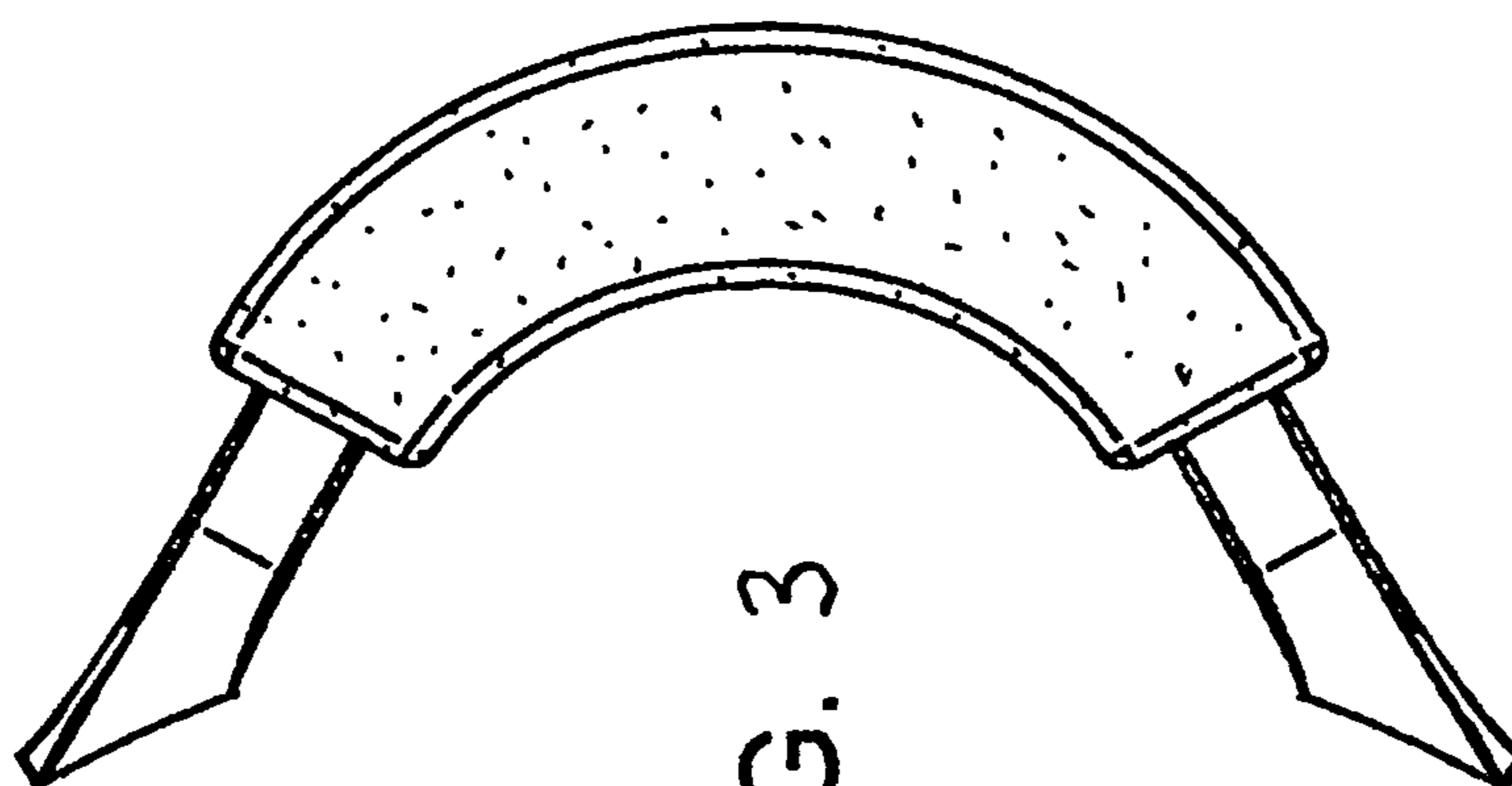

FIG. 3

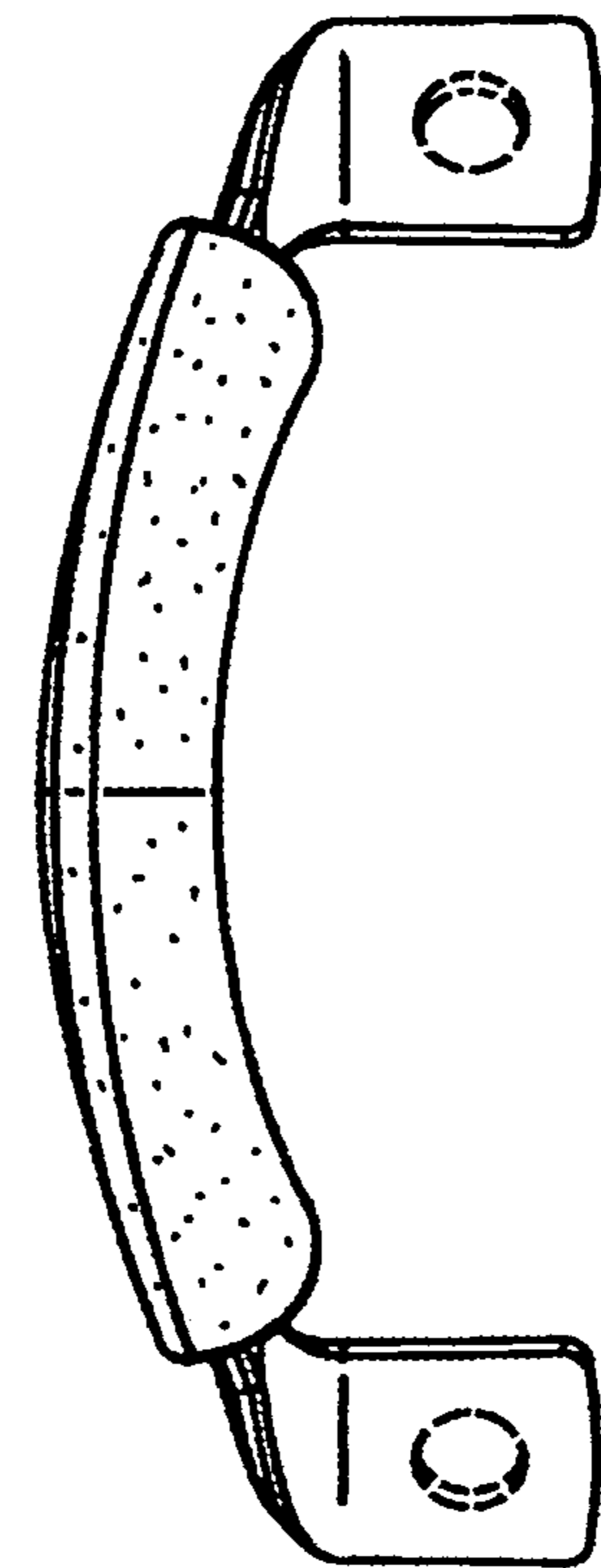

FIG. 6

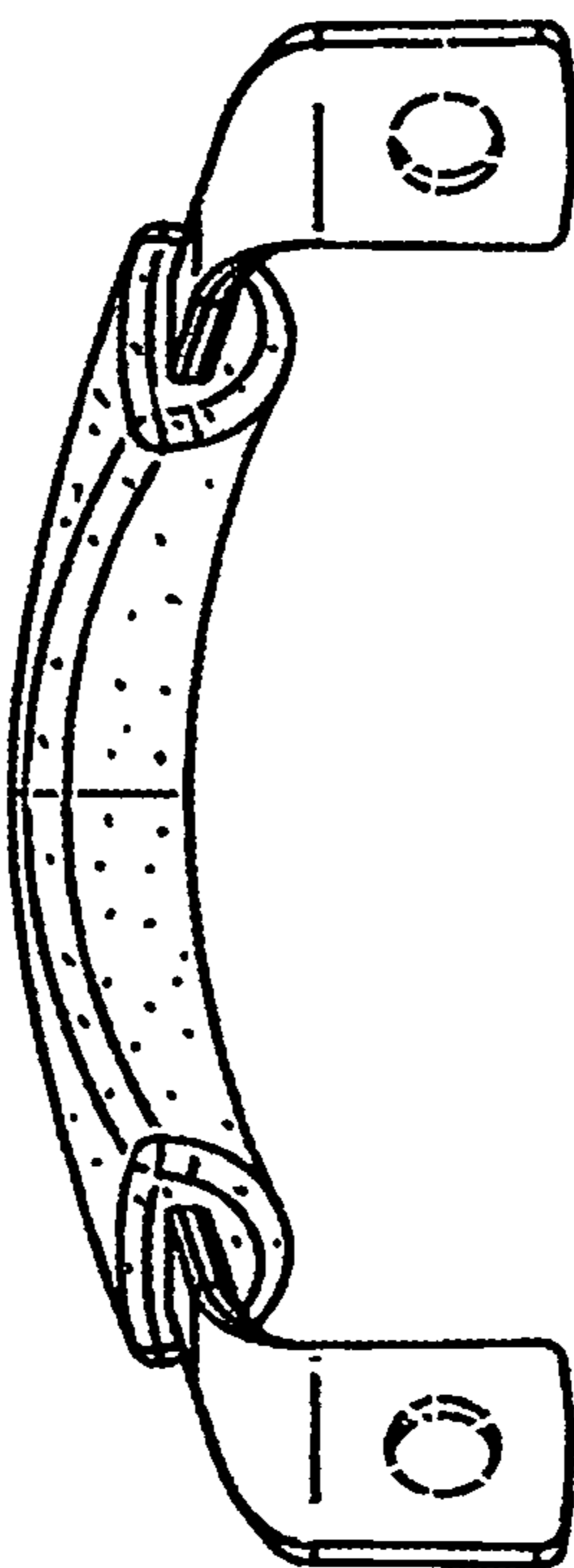

FIG. 5

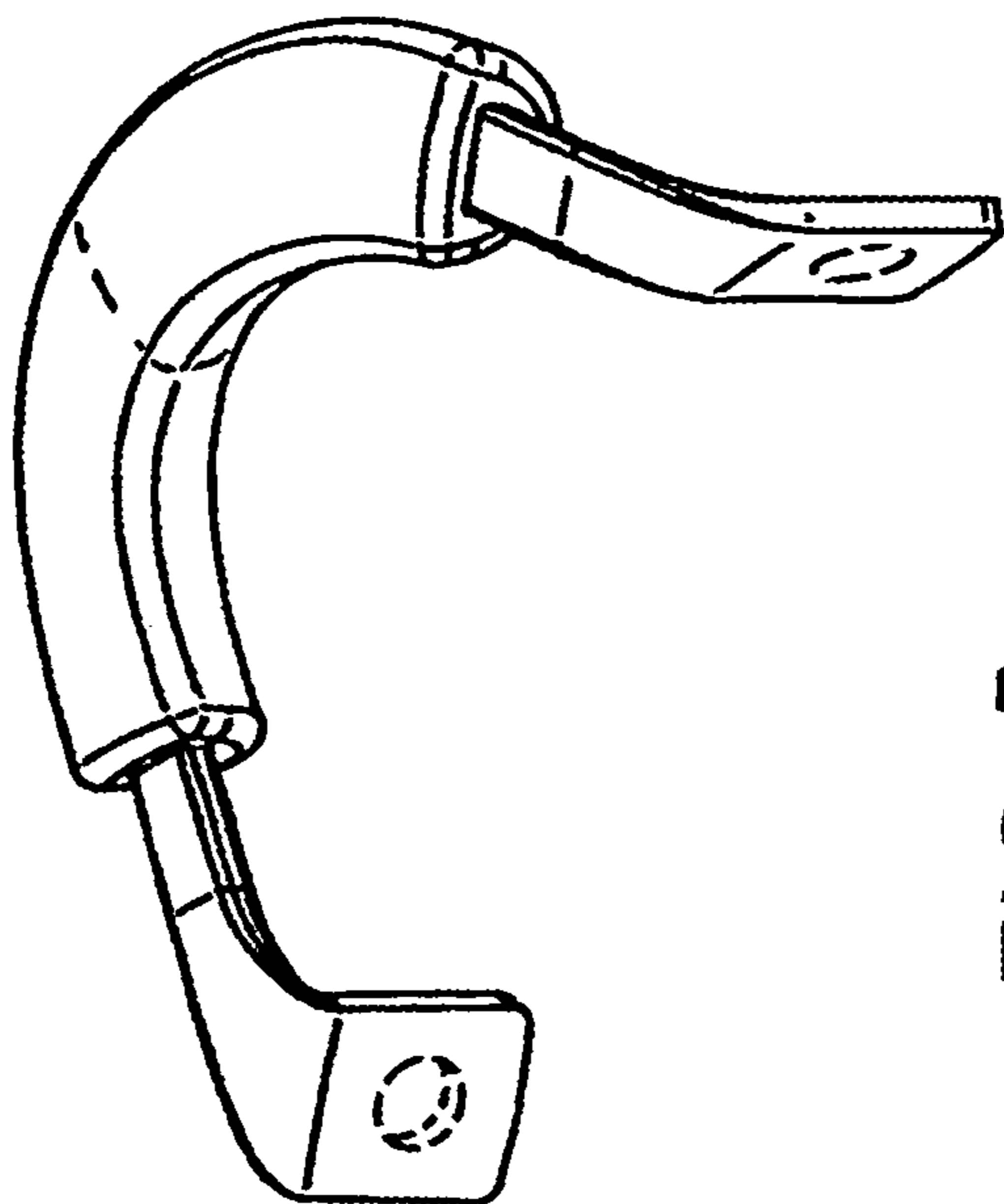

FIG. 7

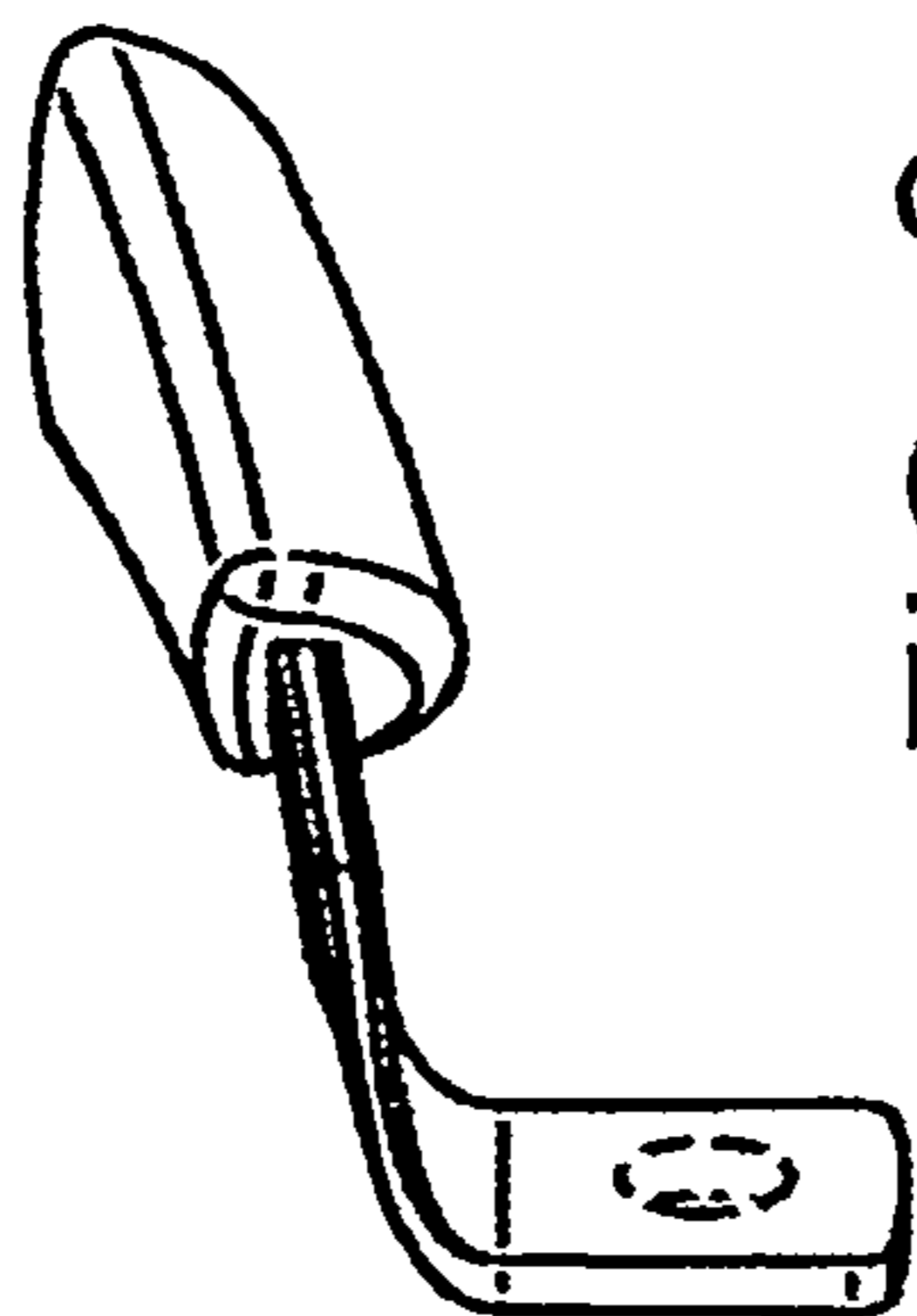

FIG. 8

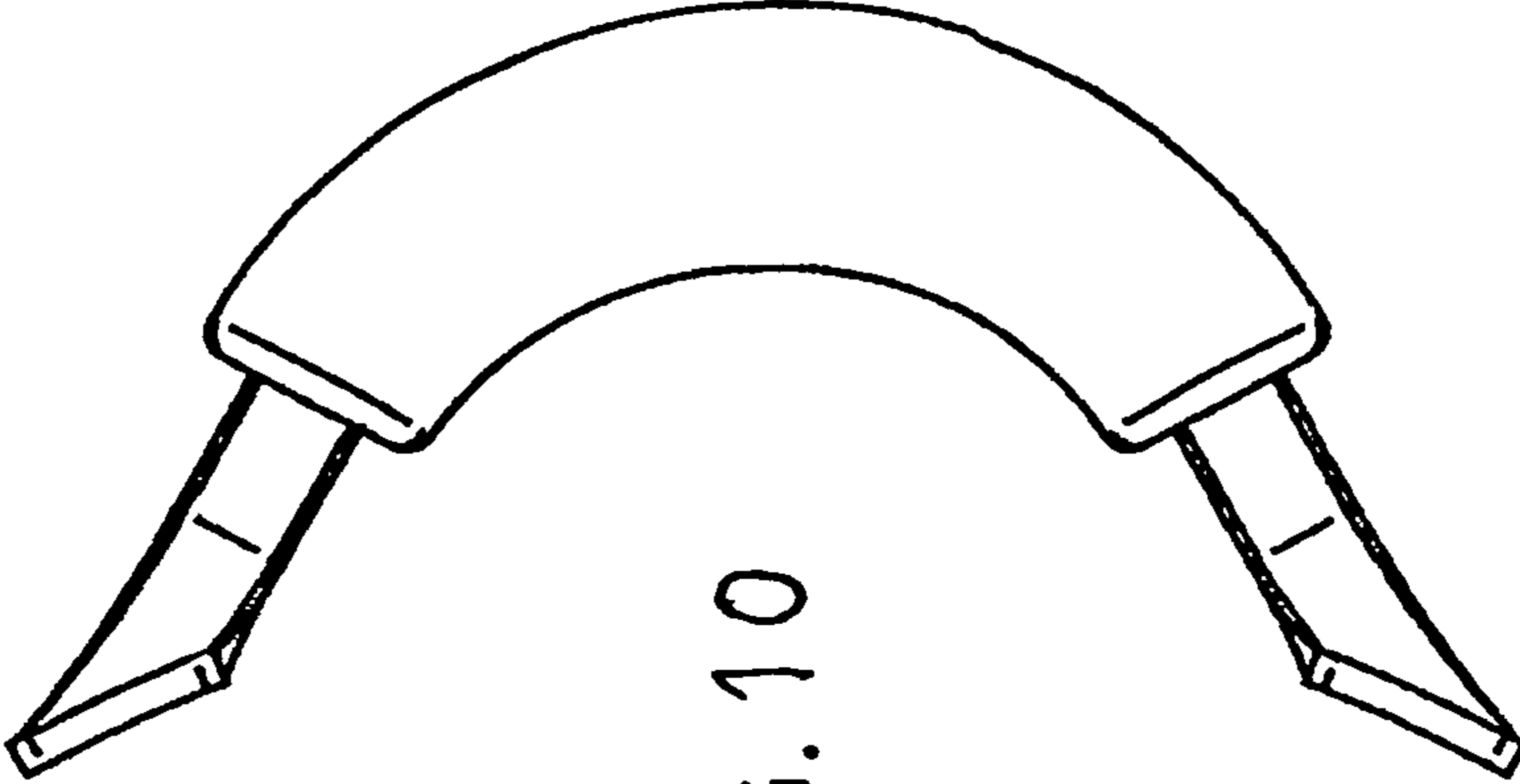

FIG. 10

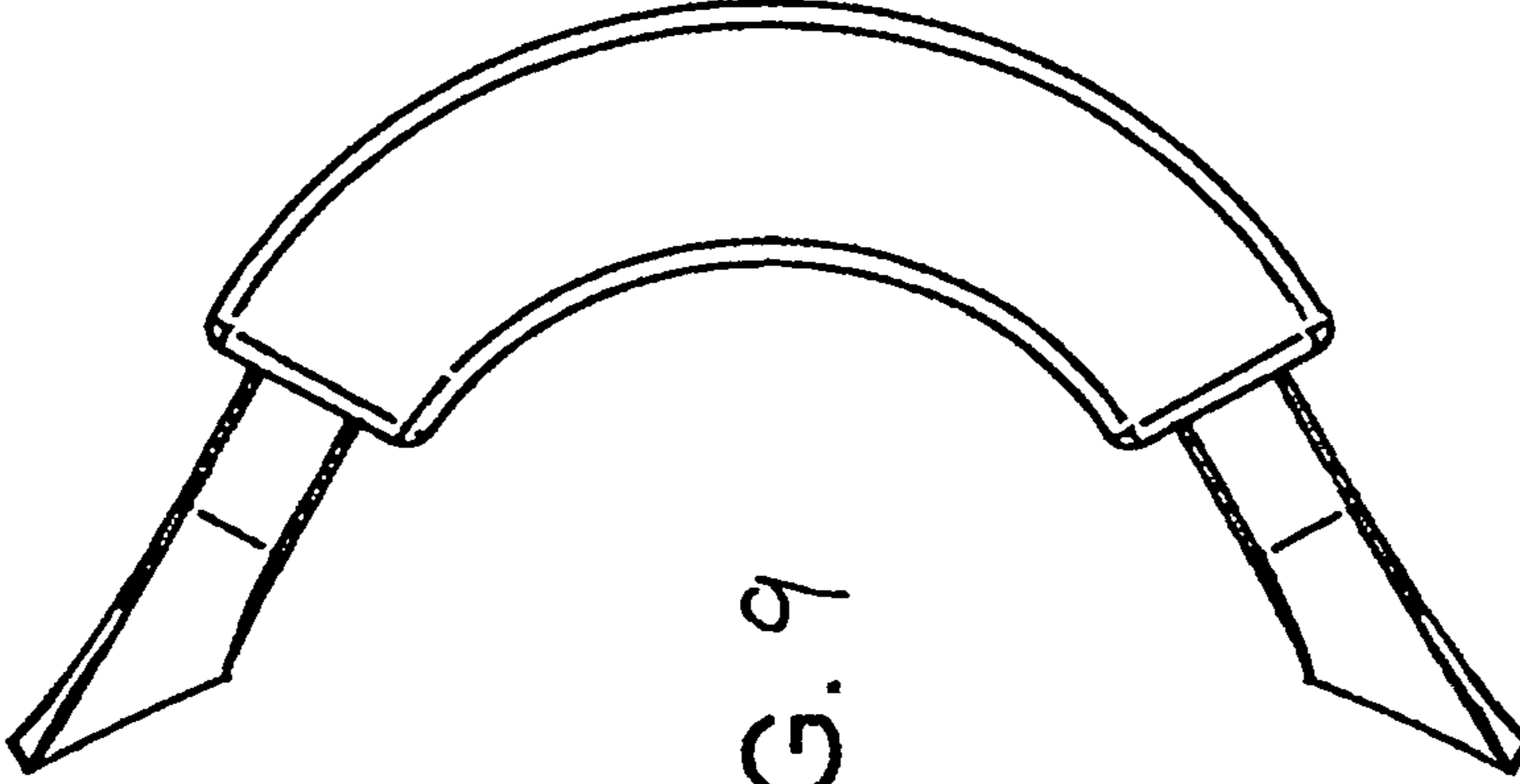

FIG. 9

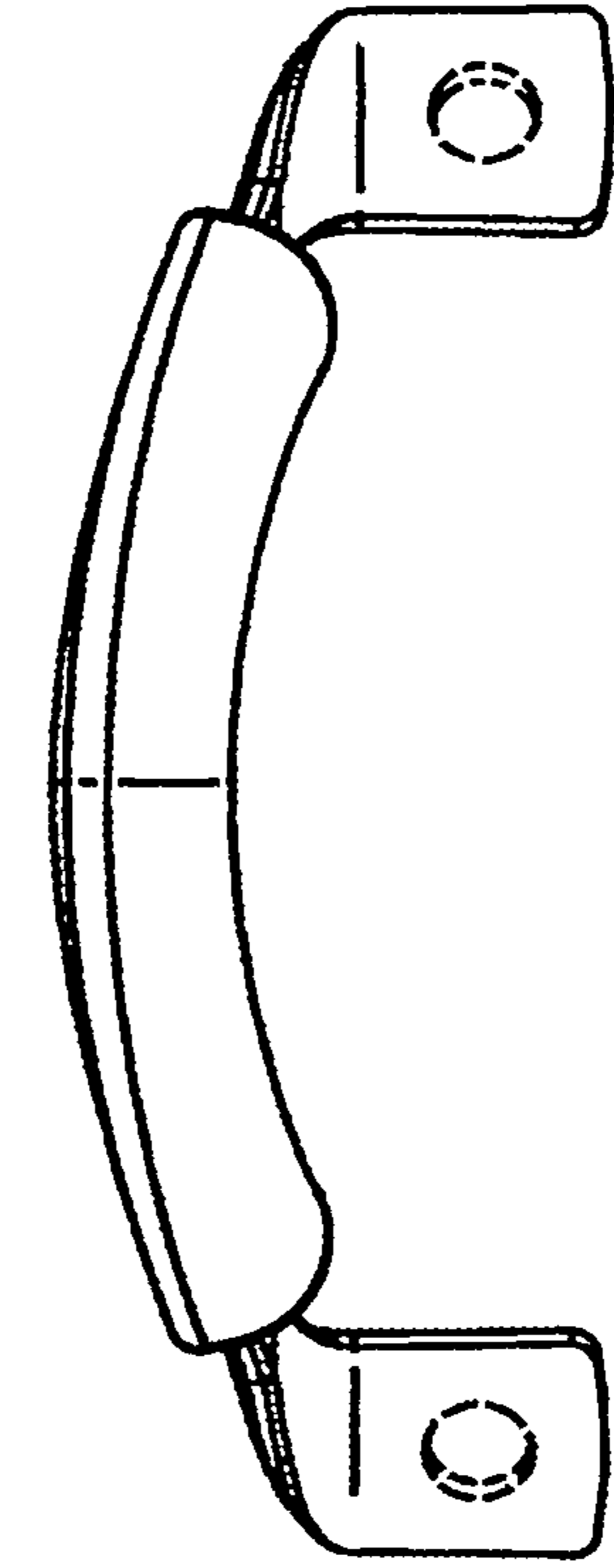

FIG. 12

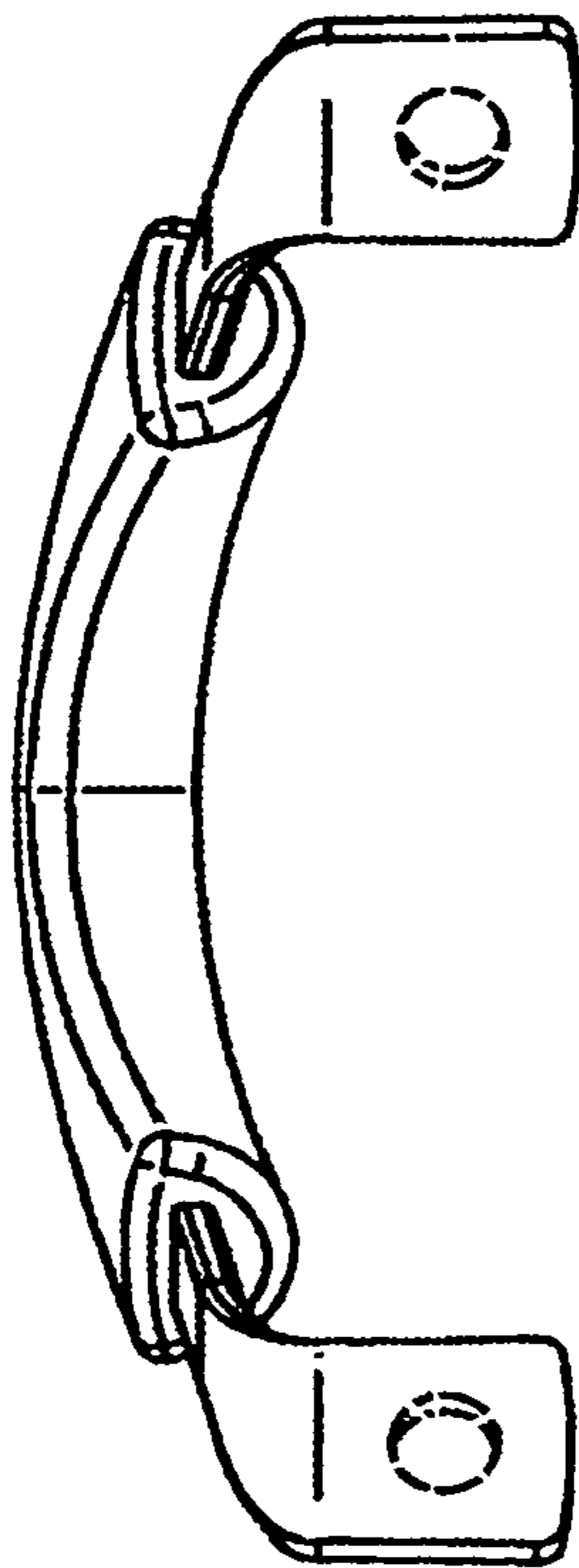

FIG. 11