



US00D713669S

(12) **United States Design Patent**
Norland et al.

(10) **Patent No.:** **US D713,669 S**

(45) **Date of Patent:** **** Sep. 23, 2014**

(54) **KETTLE**

(71) Applicant: **Whirlpool Corporation**, Benton Harbor, MI (US)

(72) Inventors: **Leif A. Norland**, Saint Joseph, MI (US);
Wenkai Wu, Iverness, IL (US)

(73) Assignee: **Whirlpool Corporation**, Benton Harbor, MI (US)

(**) Term: **14 Years**

(21) Appl. No.: **29/447,352**

(22) Filed: **Mar. 1, 2013**

(51) **LOC (10) Cl.** **07-01**

(52) **U.S. Cl.**
USPC **D7/322; D7/321**

(58) **Field of Classification Search**
CPC **A47G 19/14; A47J 31/10**
USPC **D7/322, 321, 312, 317-319; 222/1, 222/469, 500; 99/303, 323.3; 219/494, 437**
See application file for complete search history.

(56) **References Cited**

U.S. PATENT DOCUMENTS

D282,810 S *	3/1986	Urich	D7/322
D448,963 S *	10/2001	Shim	D7/322
D478,767 S *	8/2003	Lebowitz	D7/322
D490,641 S *	6/2004	Lebowitz	D7/321
D497,511 S *	10/2004	Lebowitz	D7/322
D501,355 S *	2/2005	Graves et al.	D7/322
D502,838 S *	3/2005	Ancona	D7/321
7,004,360 B2 *	2/2006	Lebowitz	222/500
D541,100 S *	4/2007	Lebowitz	D7/322
D574,657 S *	8/2008	Lebowitz	D7/321
D574,658 S *	8/2008	Grund et al.	D7/322
D574,659 S *	8/2008	Lebowitz	D7/322
D626,780 S *	11/2010	Gatto	D7/322

D638,248 S *	5/2011	Lebowitz et al.	D7/322
D683,997 S *	6/2013	Sehdev	D7/322
D683,998 S *	6/2013	Sehdev	D7/322

* cited by examiner

Primary Examiner — Marianne Pandozzi

(57) **CLAIM**

We claim the ornamental design for a kettle, as shown and described.

DESCRIPTION

FIG. 1 is a top perspective view of a kettle showing our new design;

FIG. 2 is a right side view thereof;

FIG. 3 is a left view thereof;

FIG. 4 is a front view thereof;

FIG. 5 is a rear view thereof;

FIG. 6 is a top plan view thereof;

FIG. 7 is a bottom plan view thereof;

FIG. 8 is a top perspective view of a kettle showing a second embodiment of our new design;

FIG. 9 is a right side view thereof;

FIG. 10 is a left view thereof;

FIG. 11 is a front view thereof;

FIG. 12 is a rear side view thereof;

FIG. 13 is a top plan view thereof;

FIG. 14 is a bottom plan view thereof;

FIG. 15 is a top perspective view of a kettle showing our new design;

FIG. 16 is a right side view thereof;

FIG. 17 is a left view thereof;

FIG. 18 is a front view thereof;

FIG. 19 is a rear side view thereof;

FIG. 20 is a top plan view thereof; and,

FIG. 21 is a bottom plan view thereof.

The broken lines in the drawings are included for the purpose of illustration and form no part of the claimed design.

1 Claim, 21 Drawing Sheets

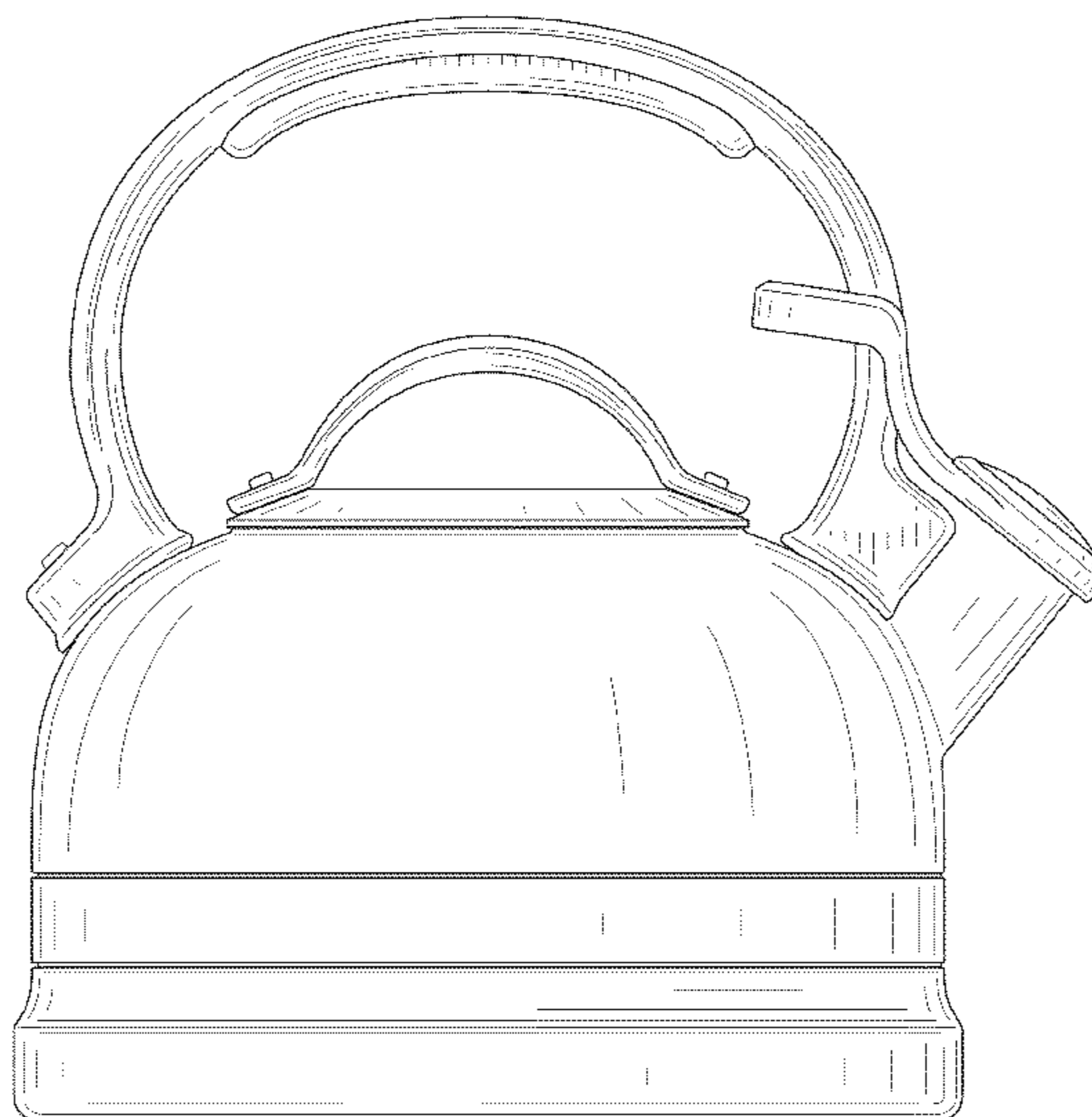

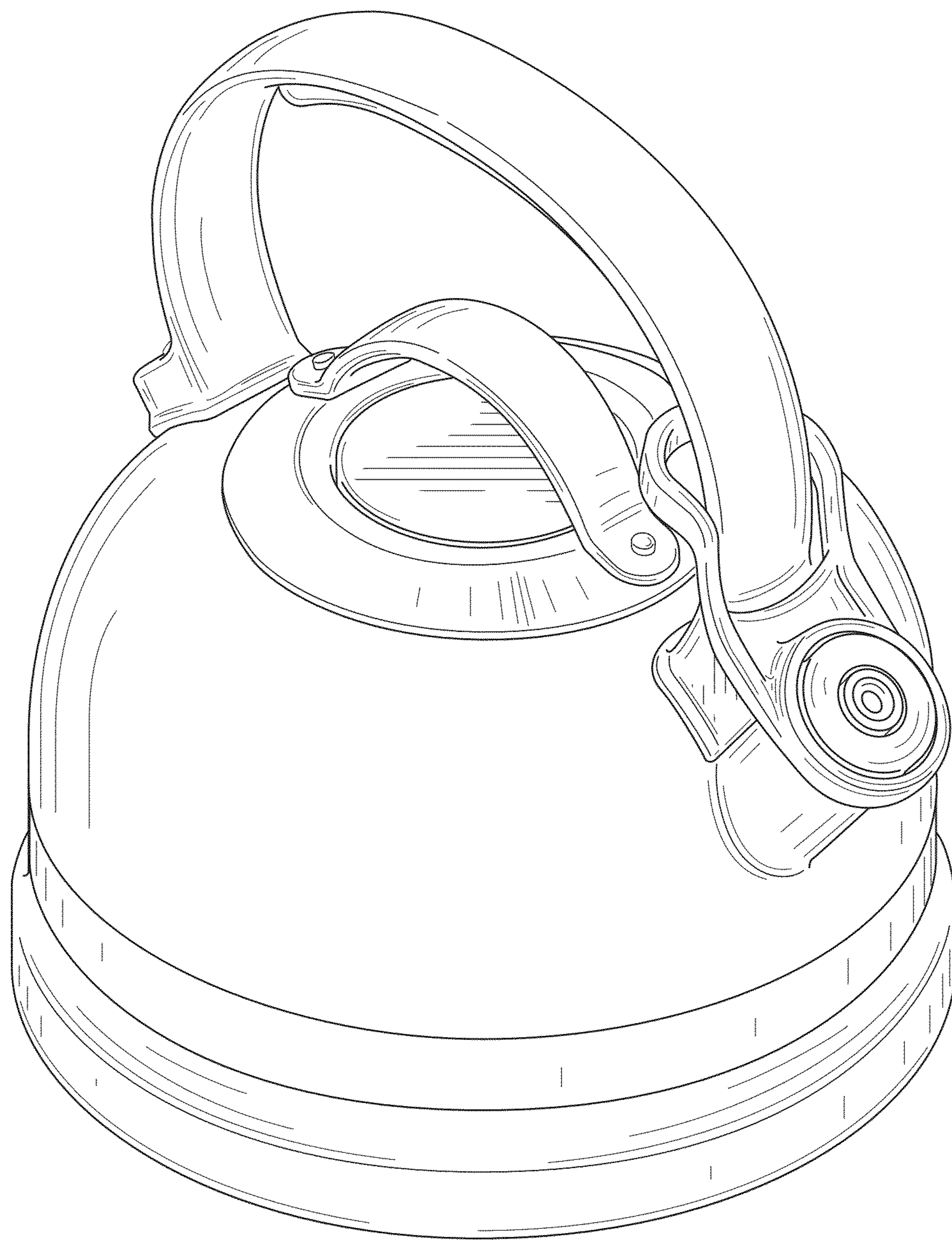

FIG. 1

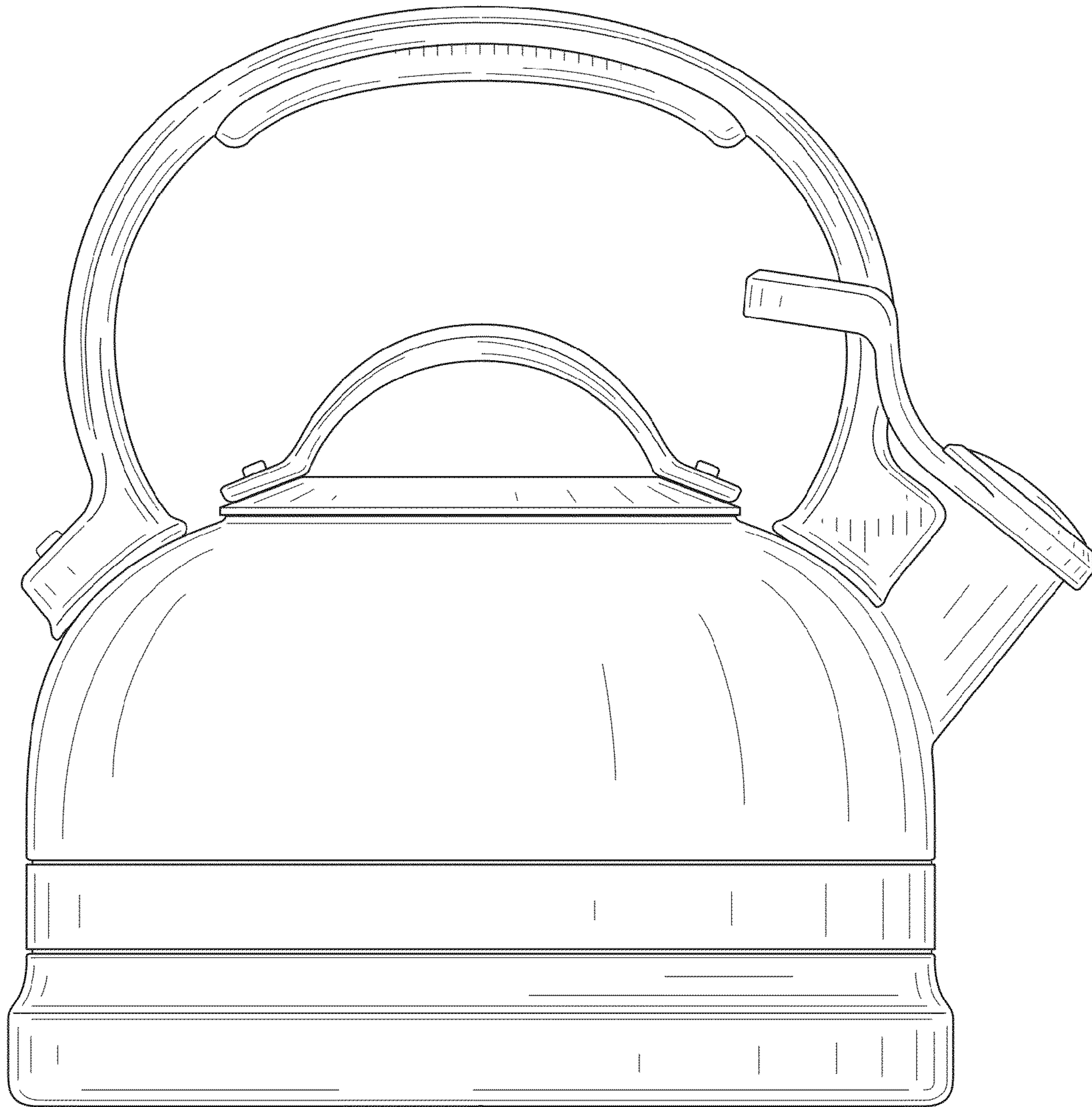

FIG. 2

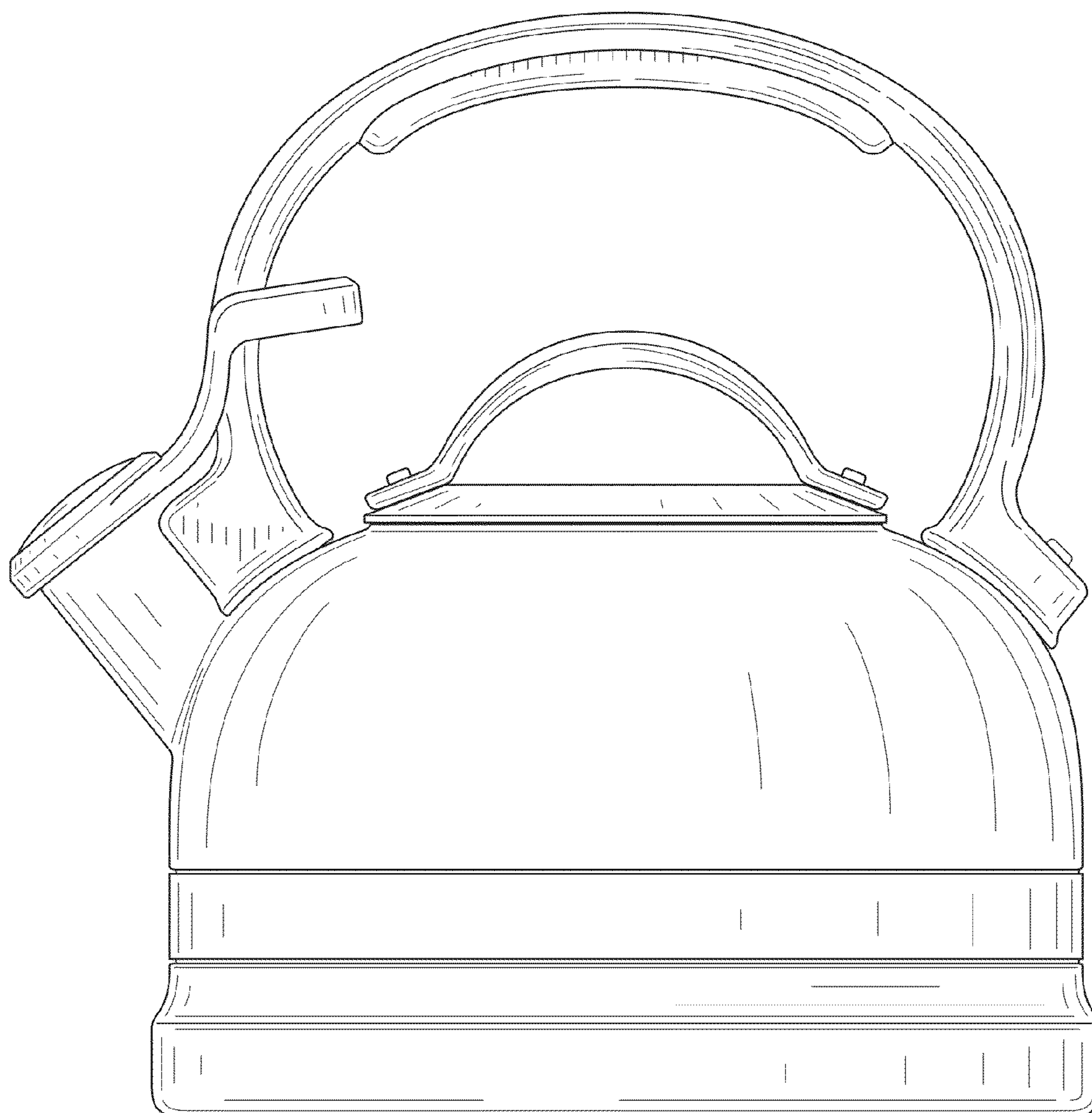

FIG. 3

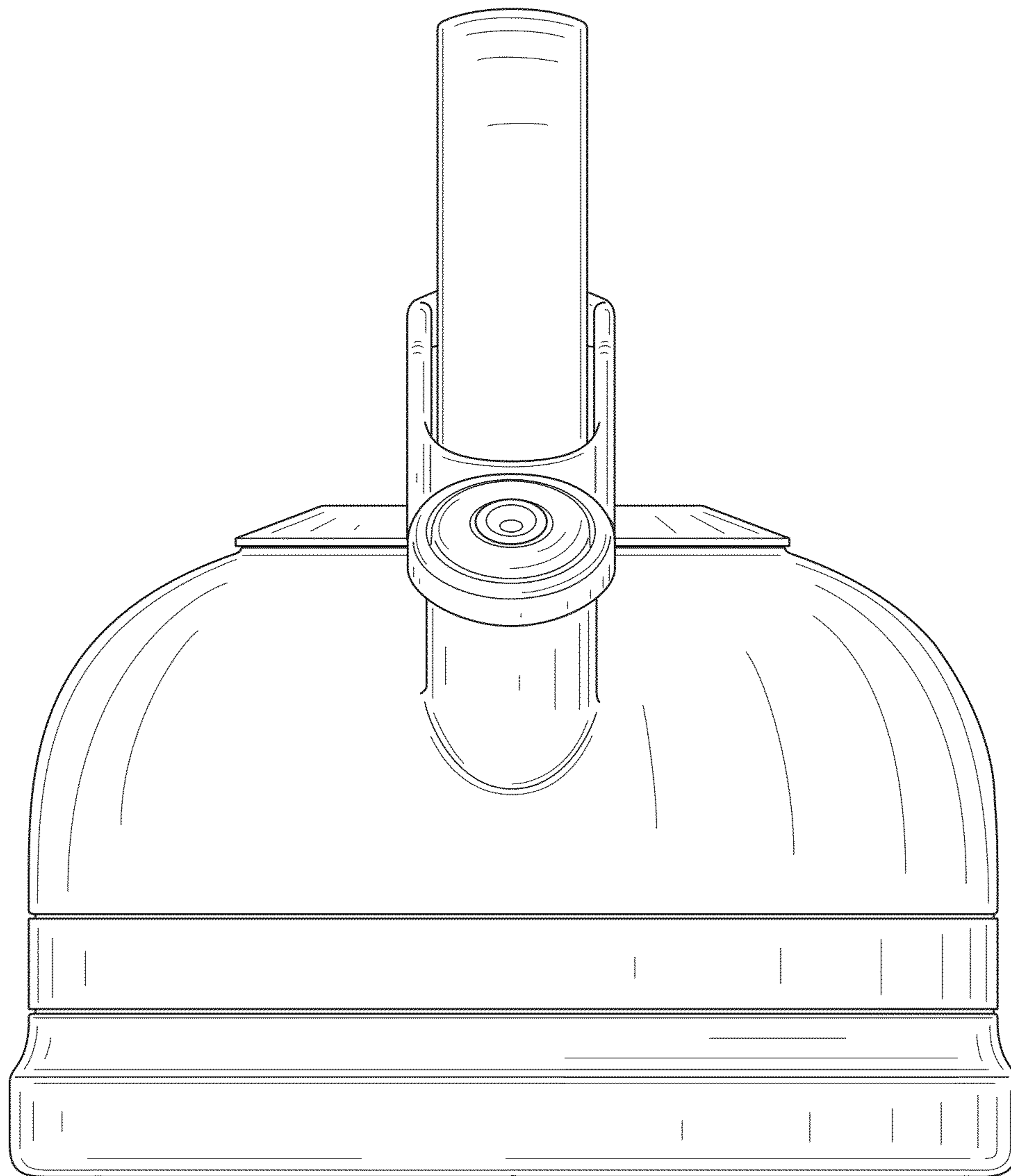

FIG. 4

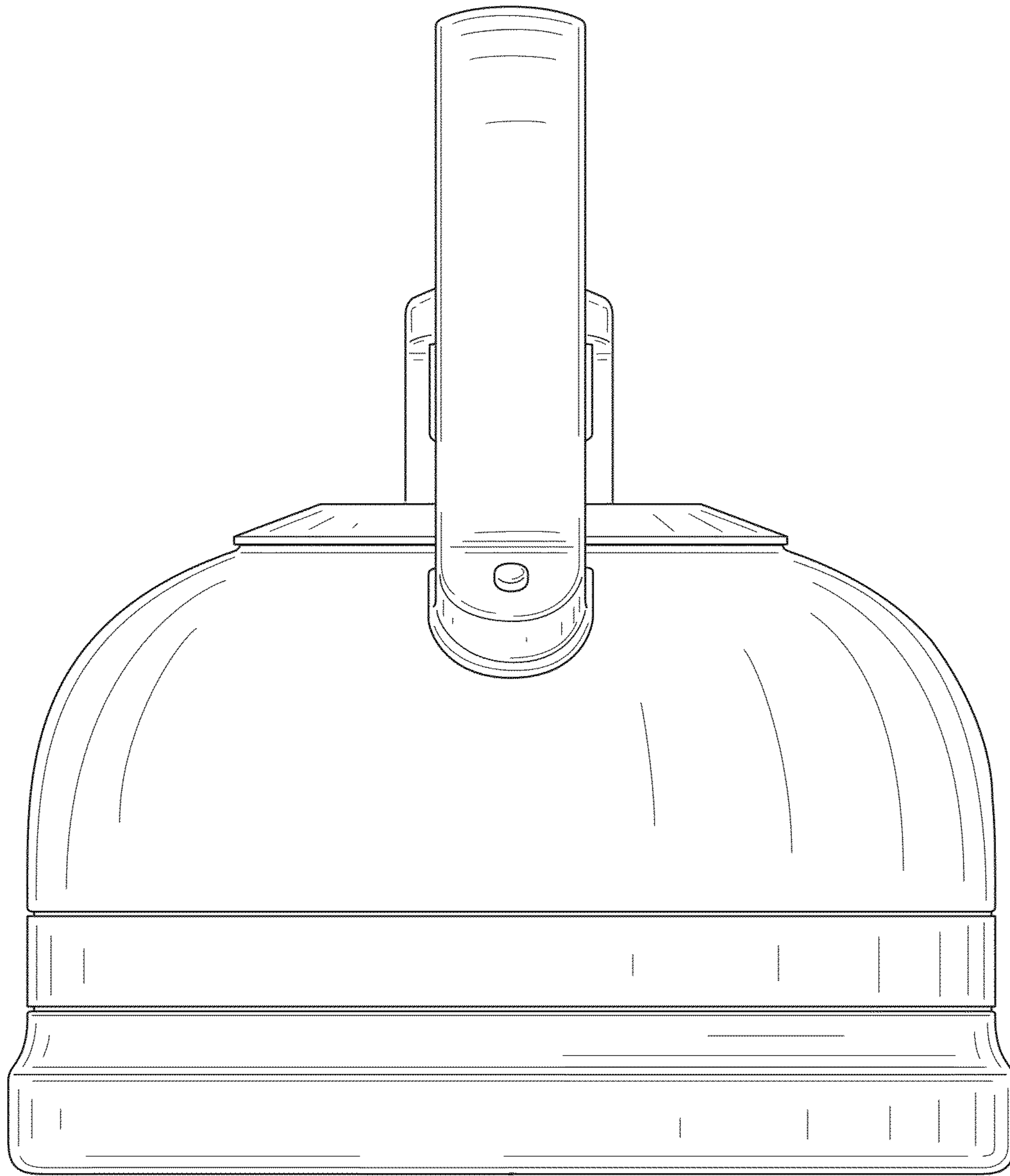

FIG. 5

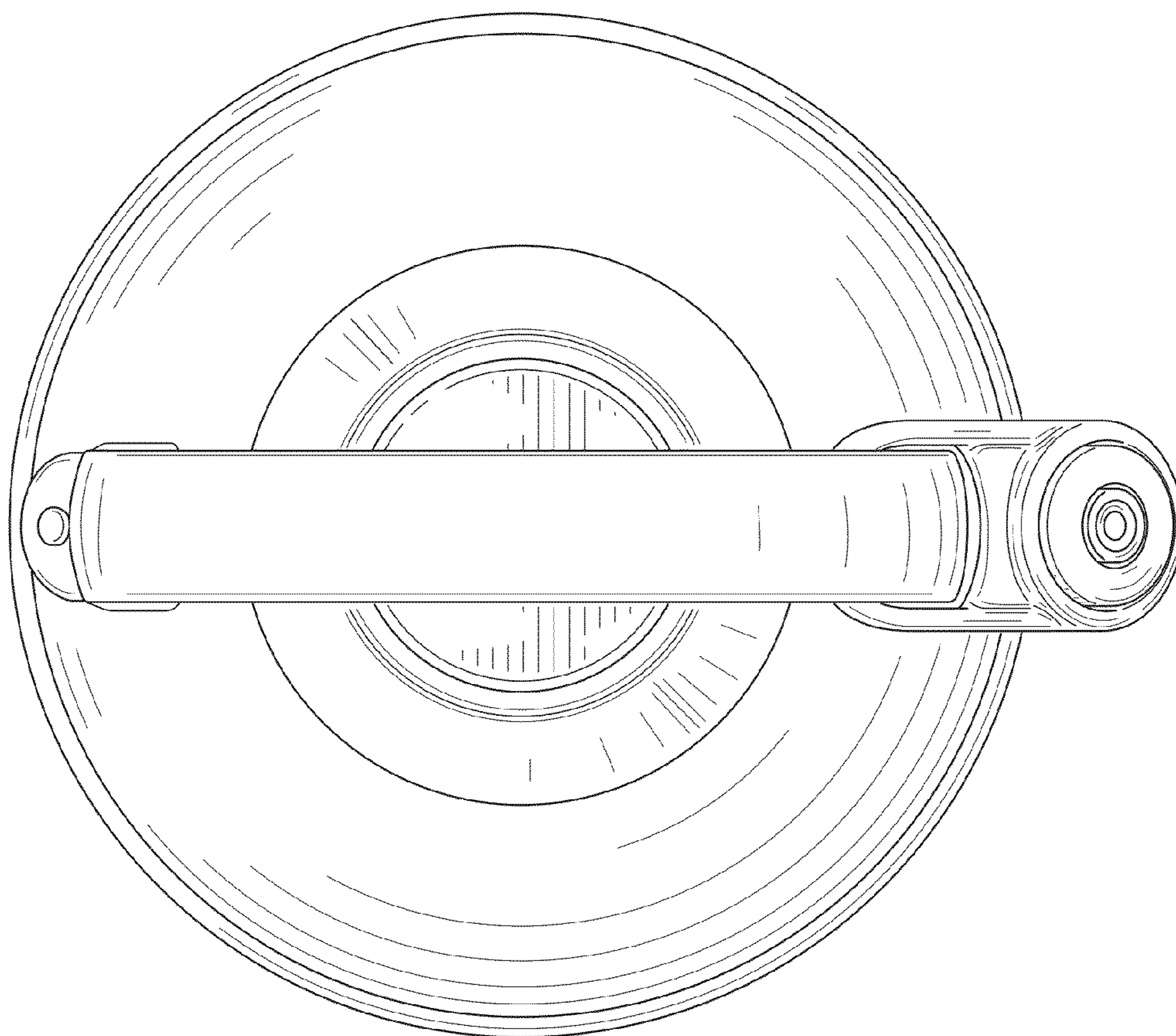

FIG. 6

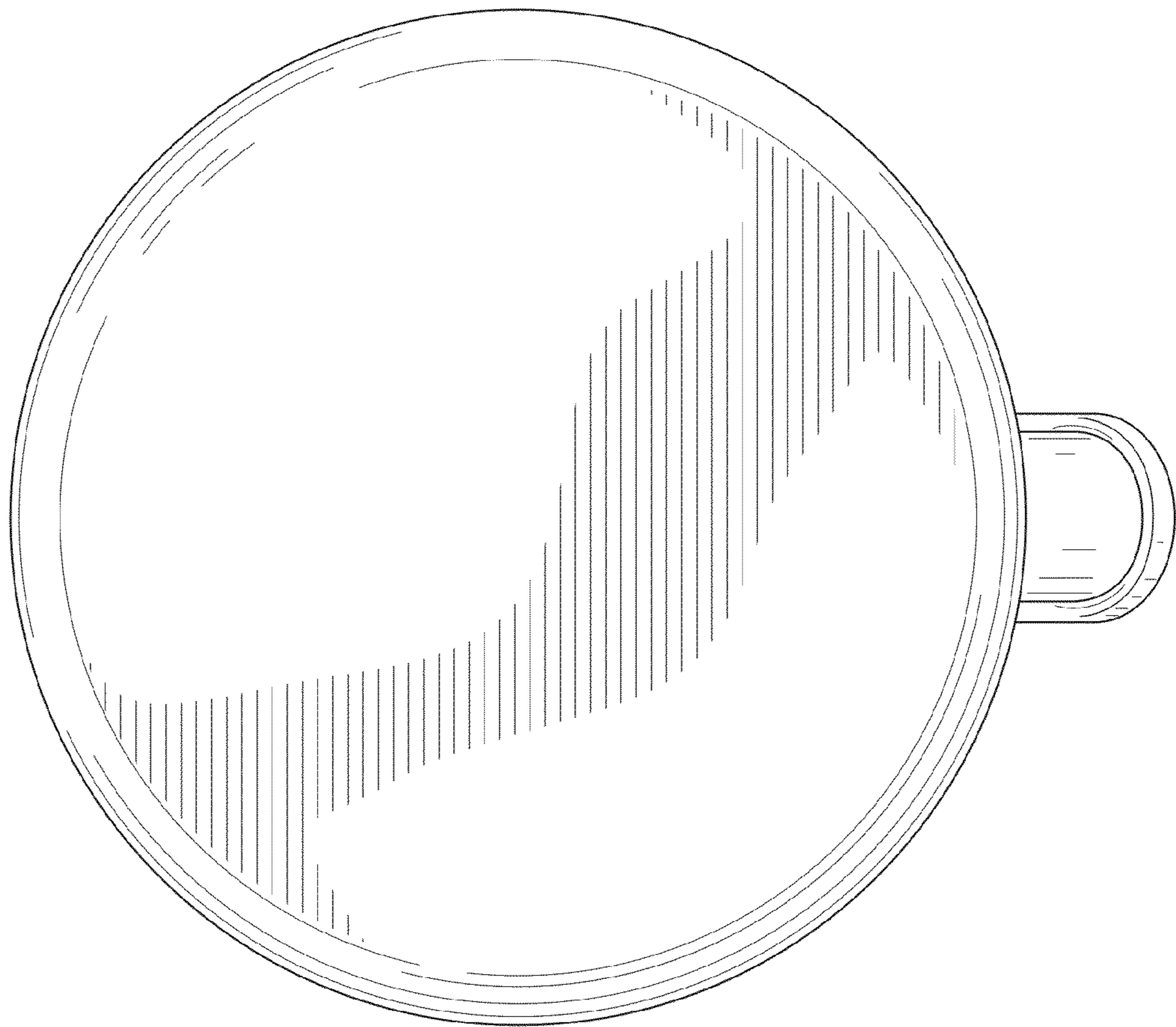

FIG. 7

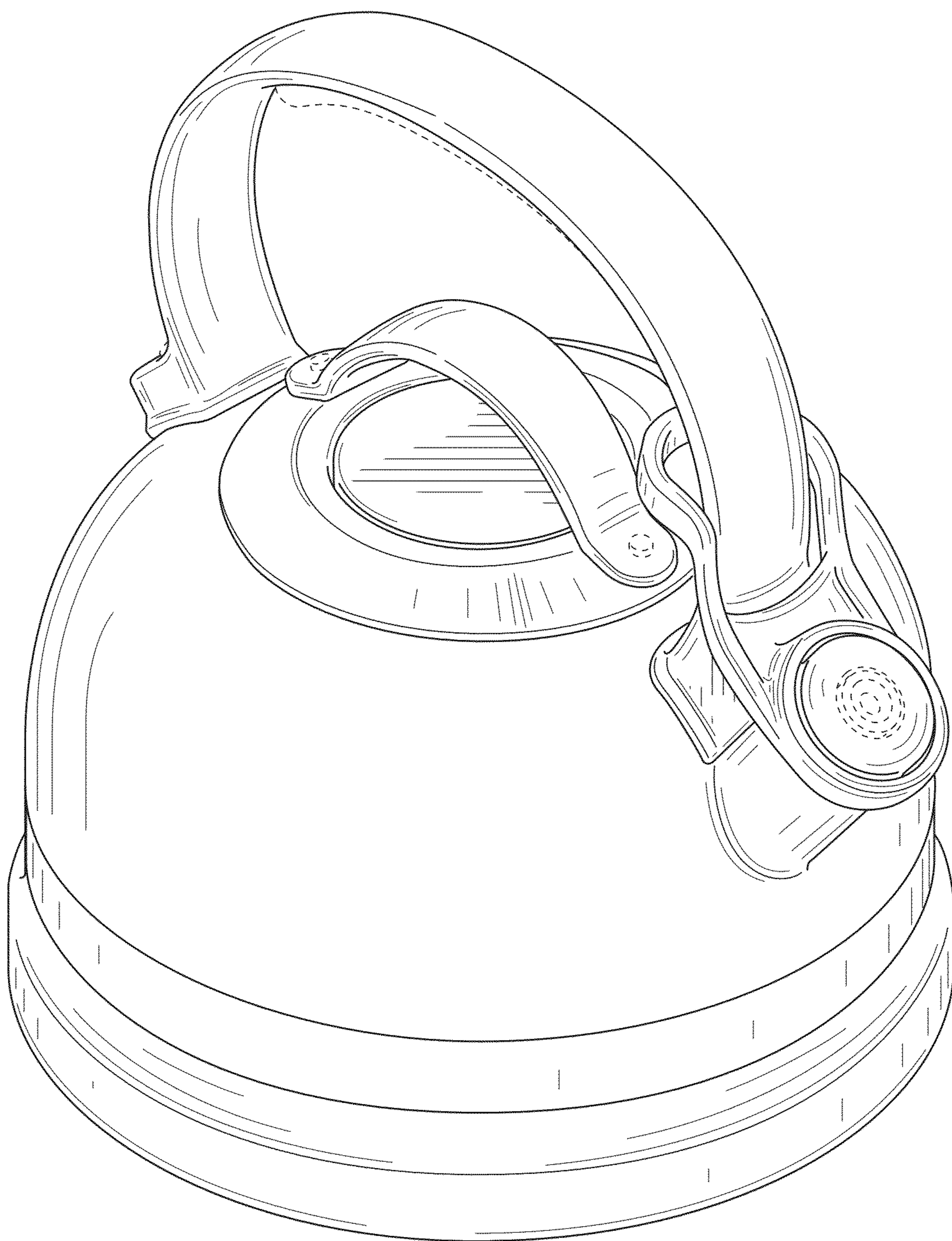

FIG. 8

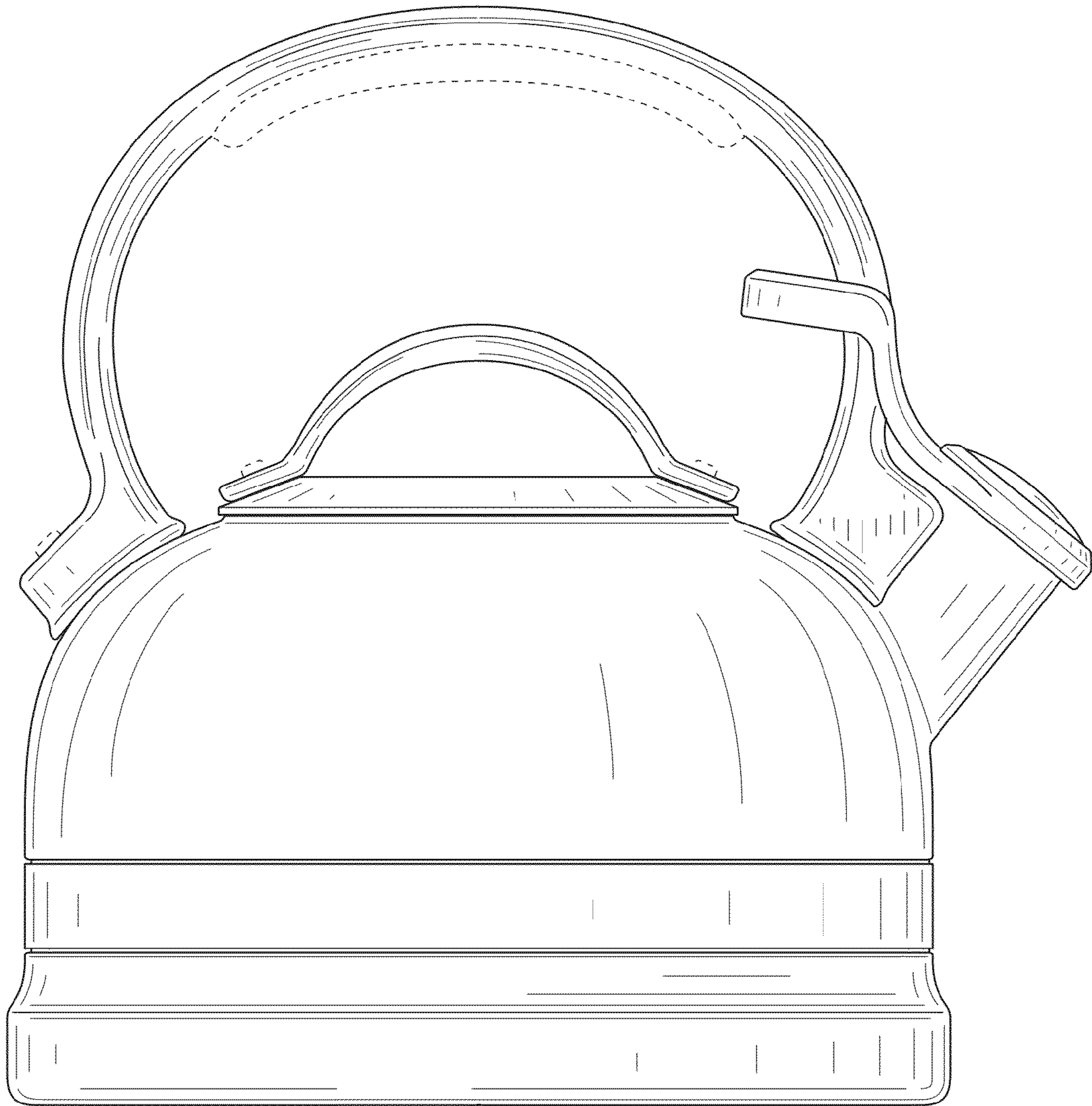

FIG. 9

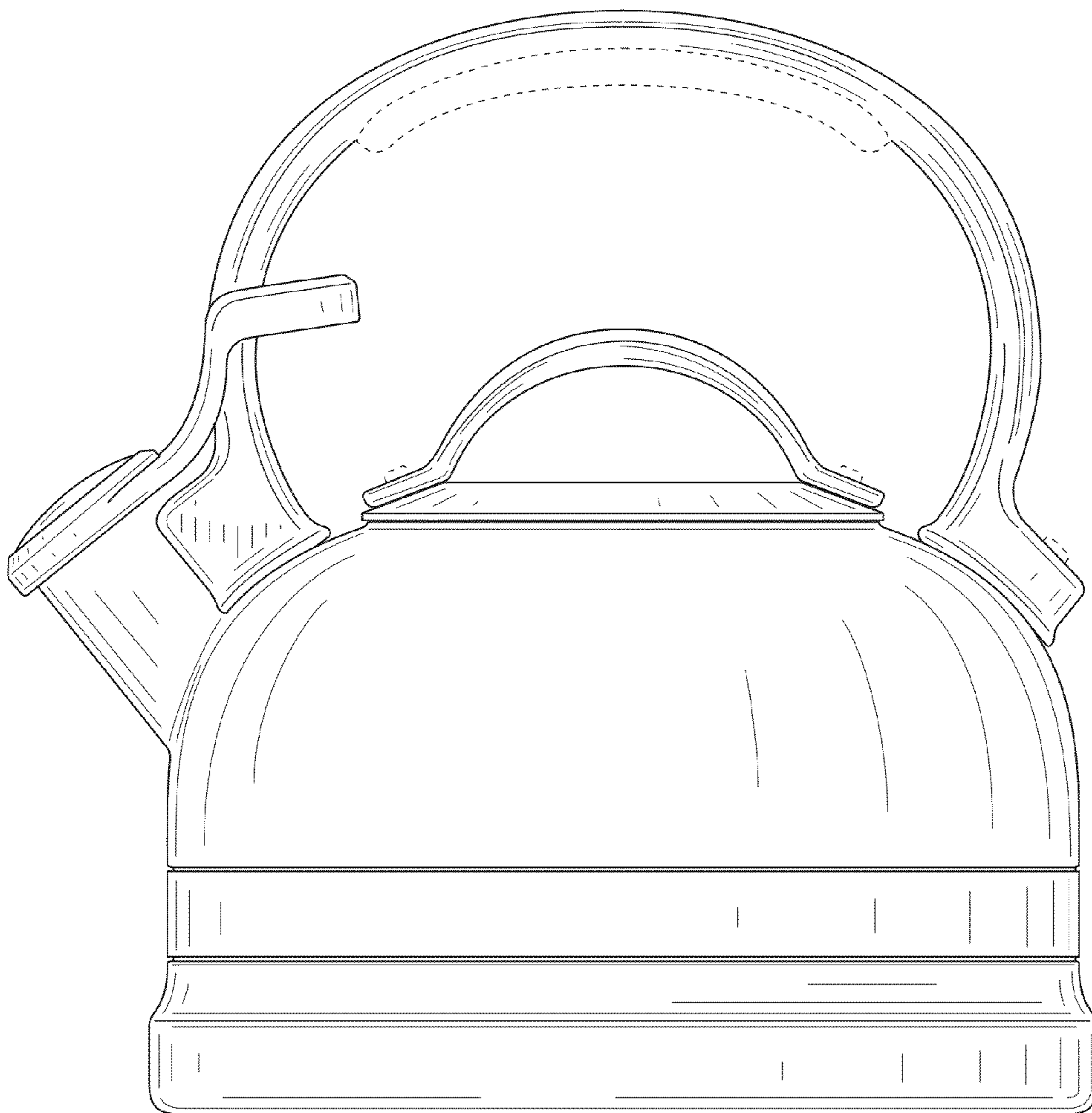

FIG. 10

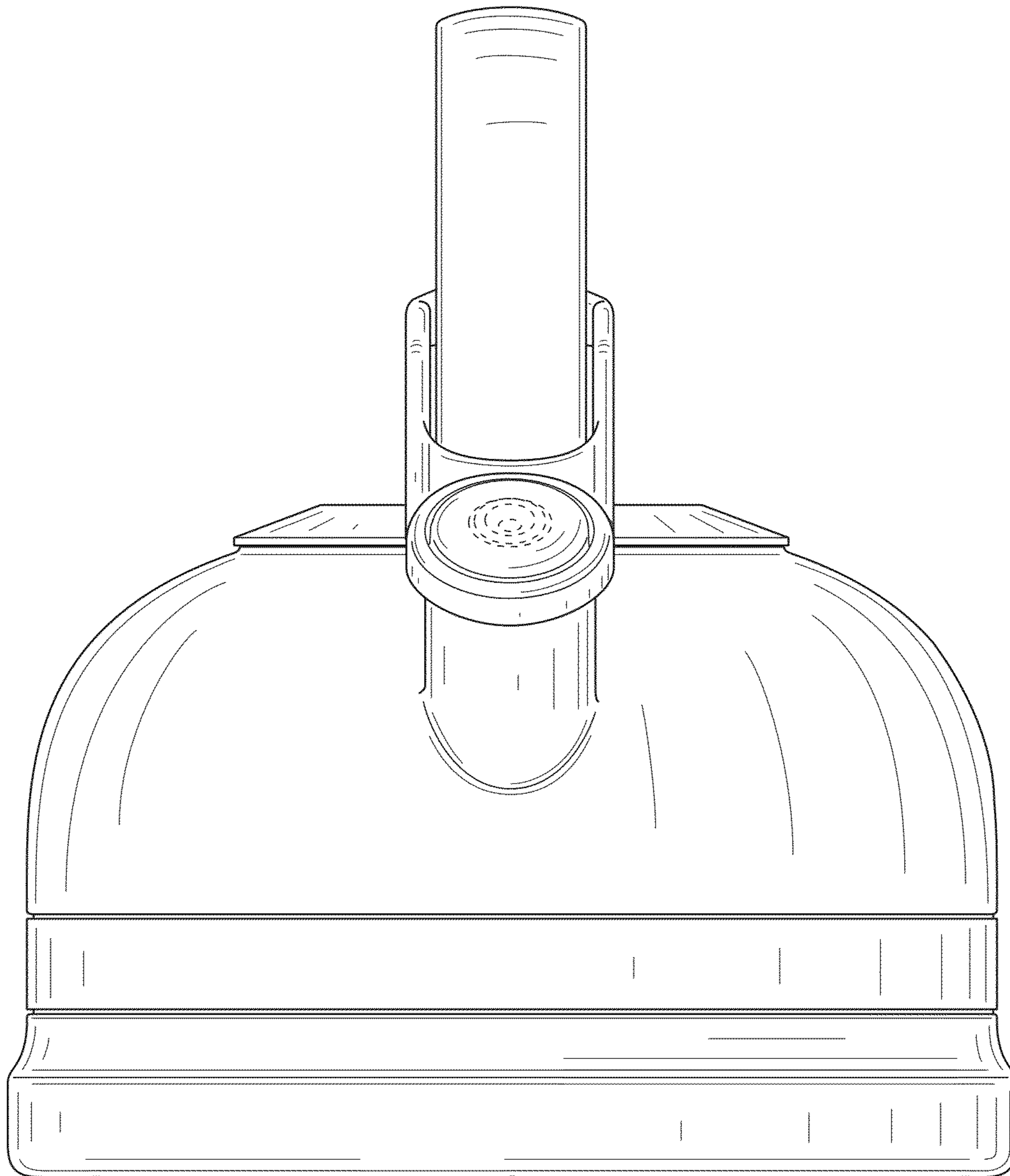

FIG. 11

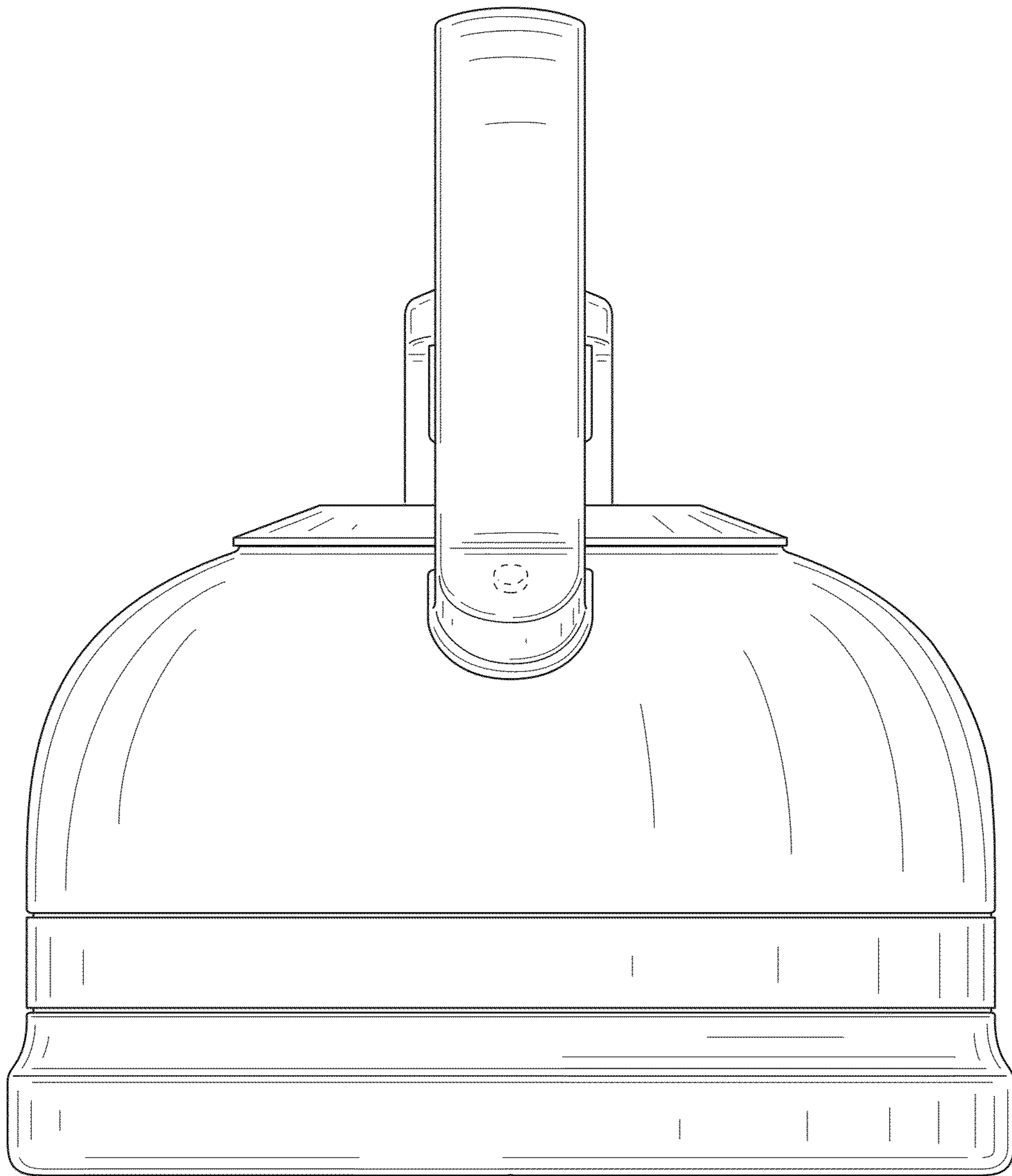

FIG. 12

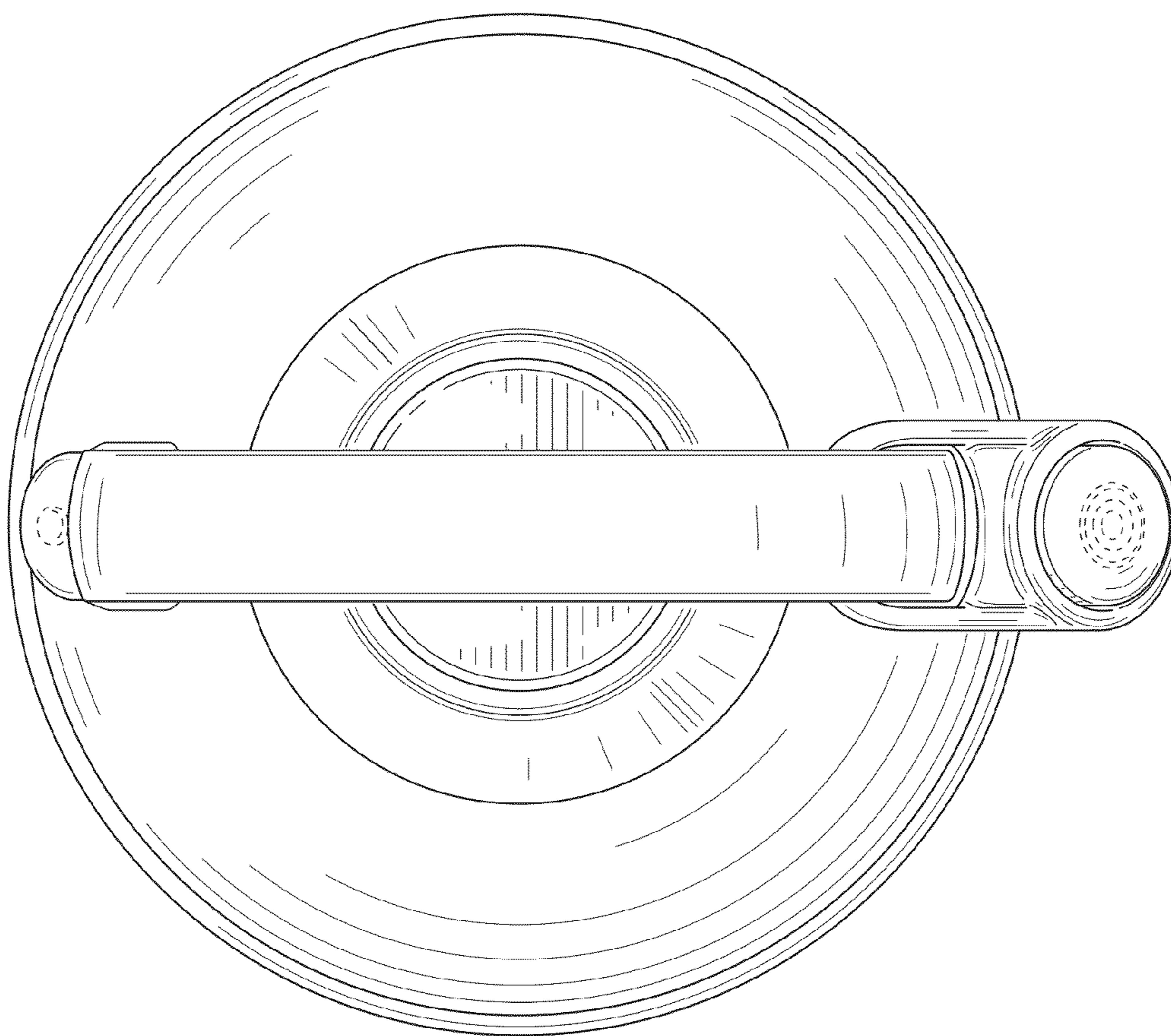

FIG. 13

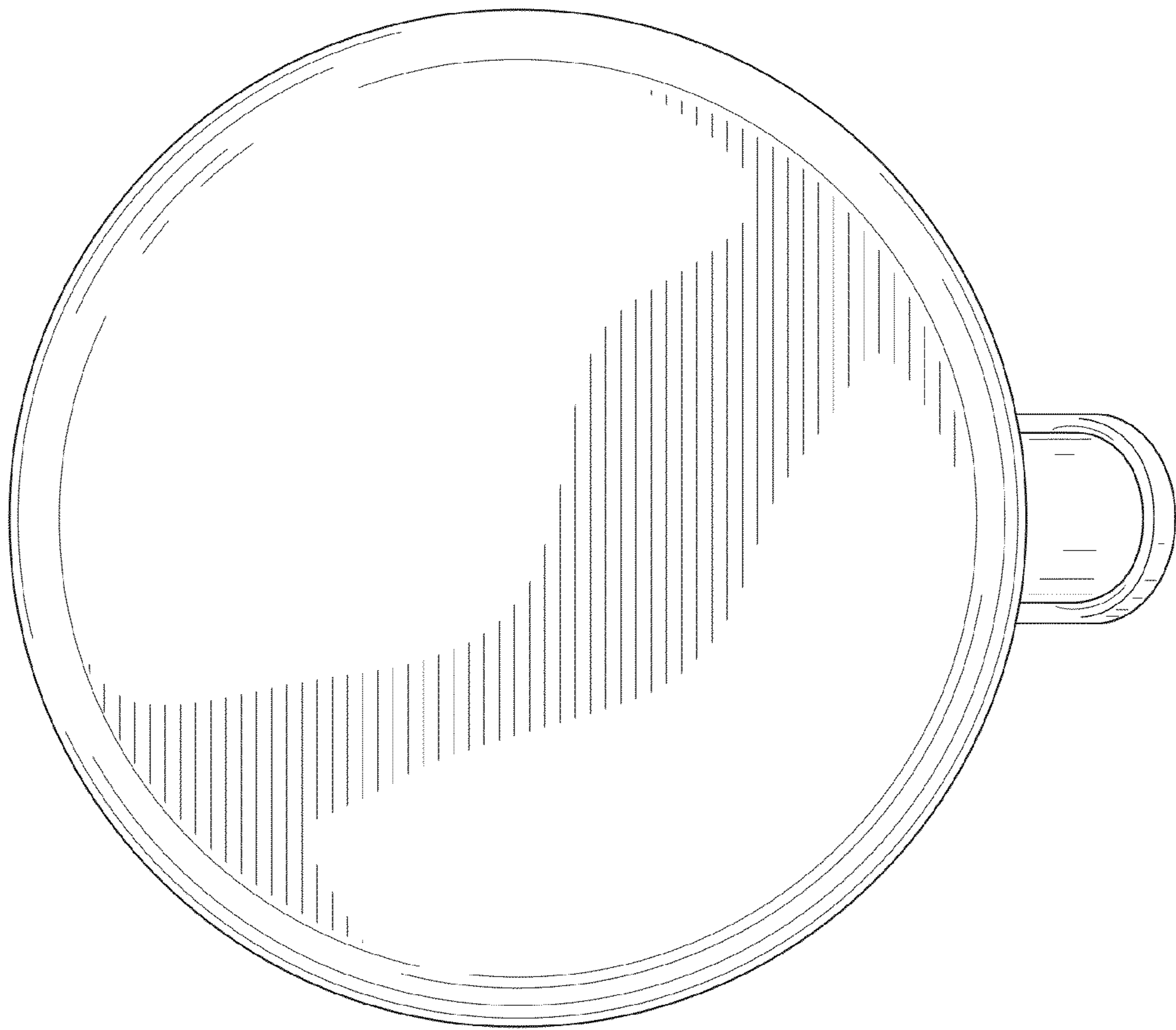

FIG. 14

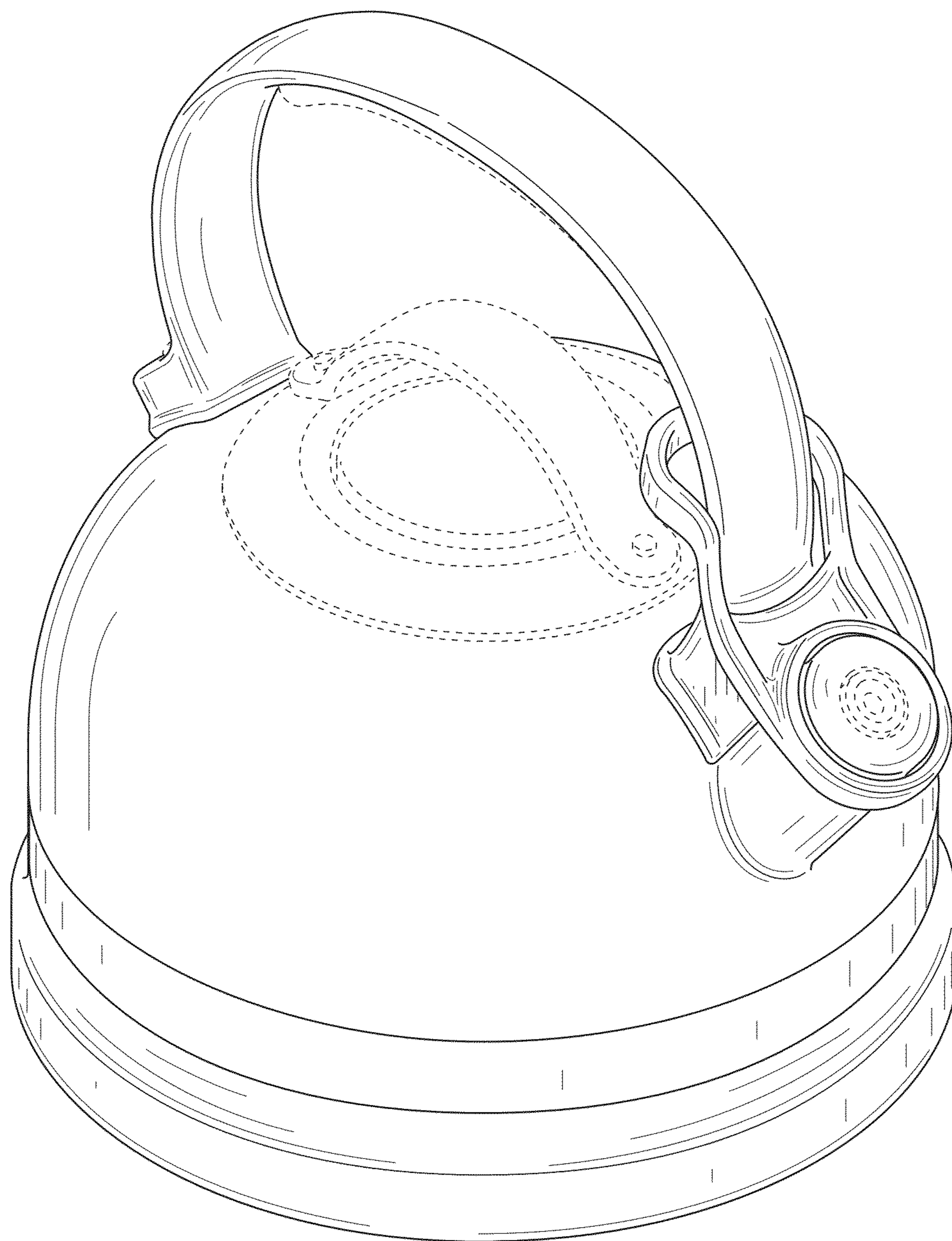

FIG. 15

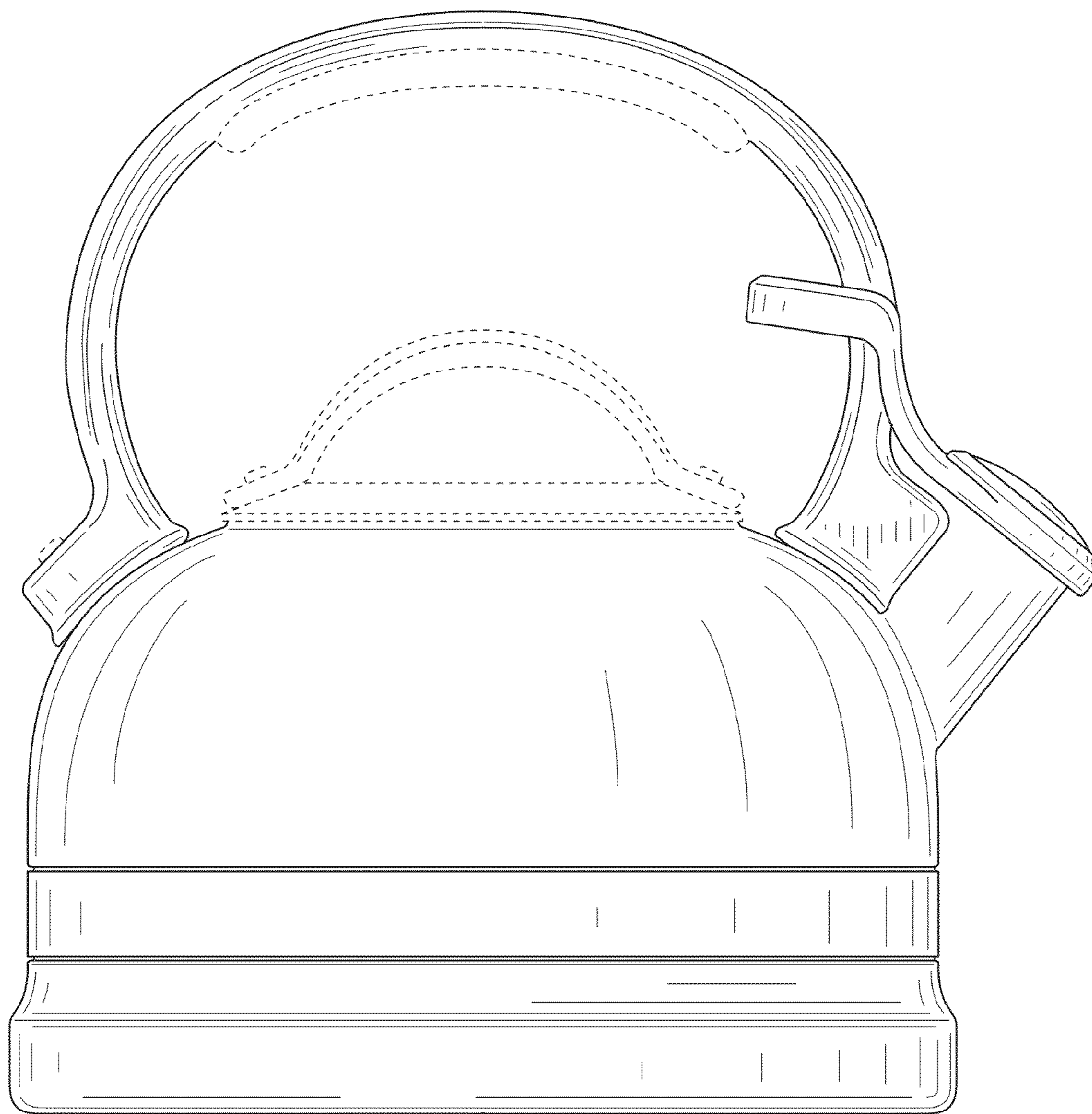

FIG. 16

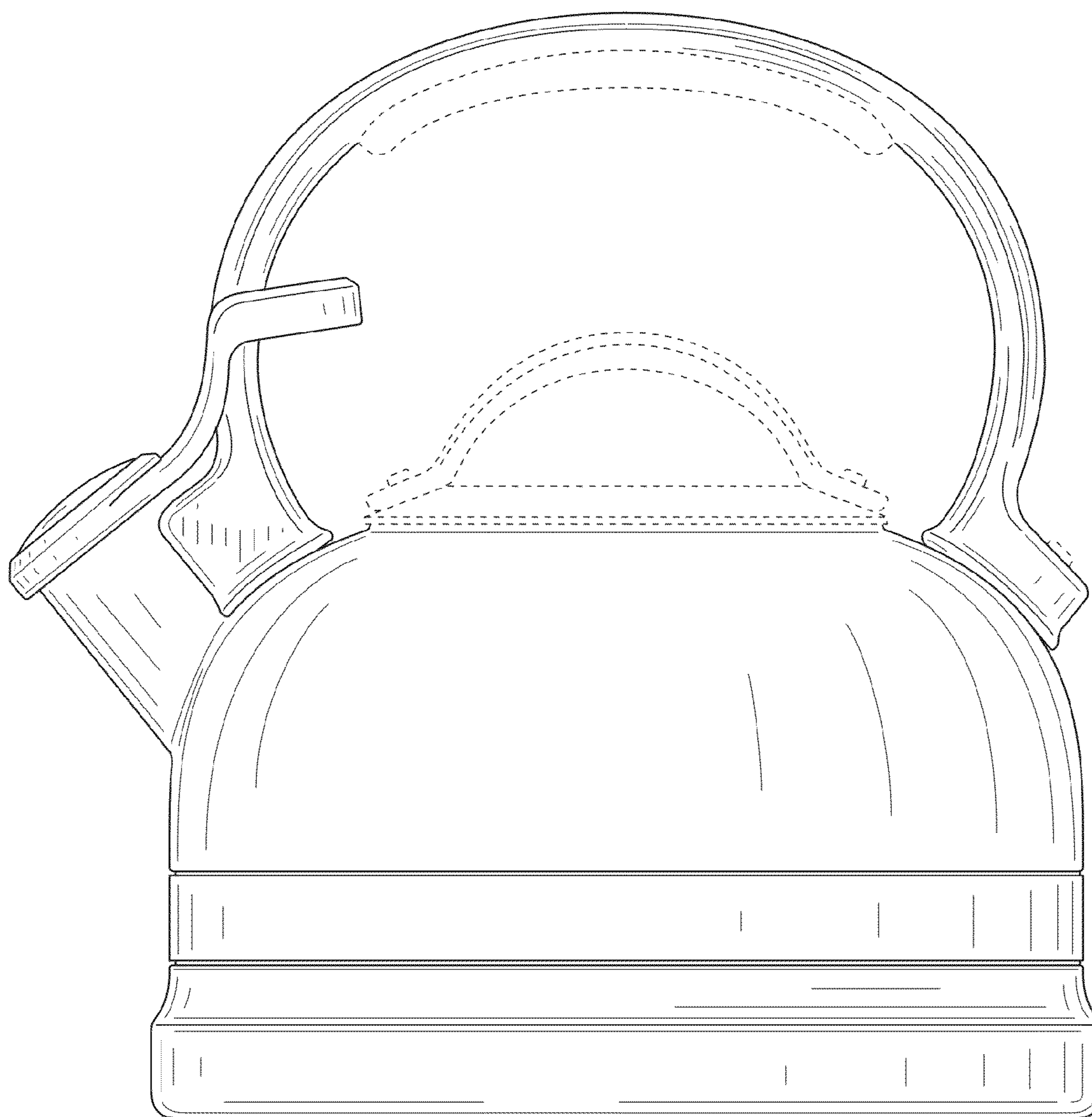

FIG. 17

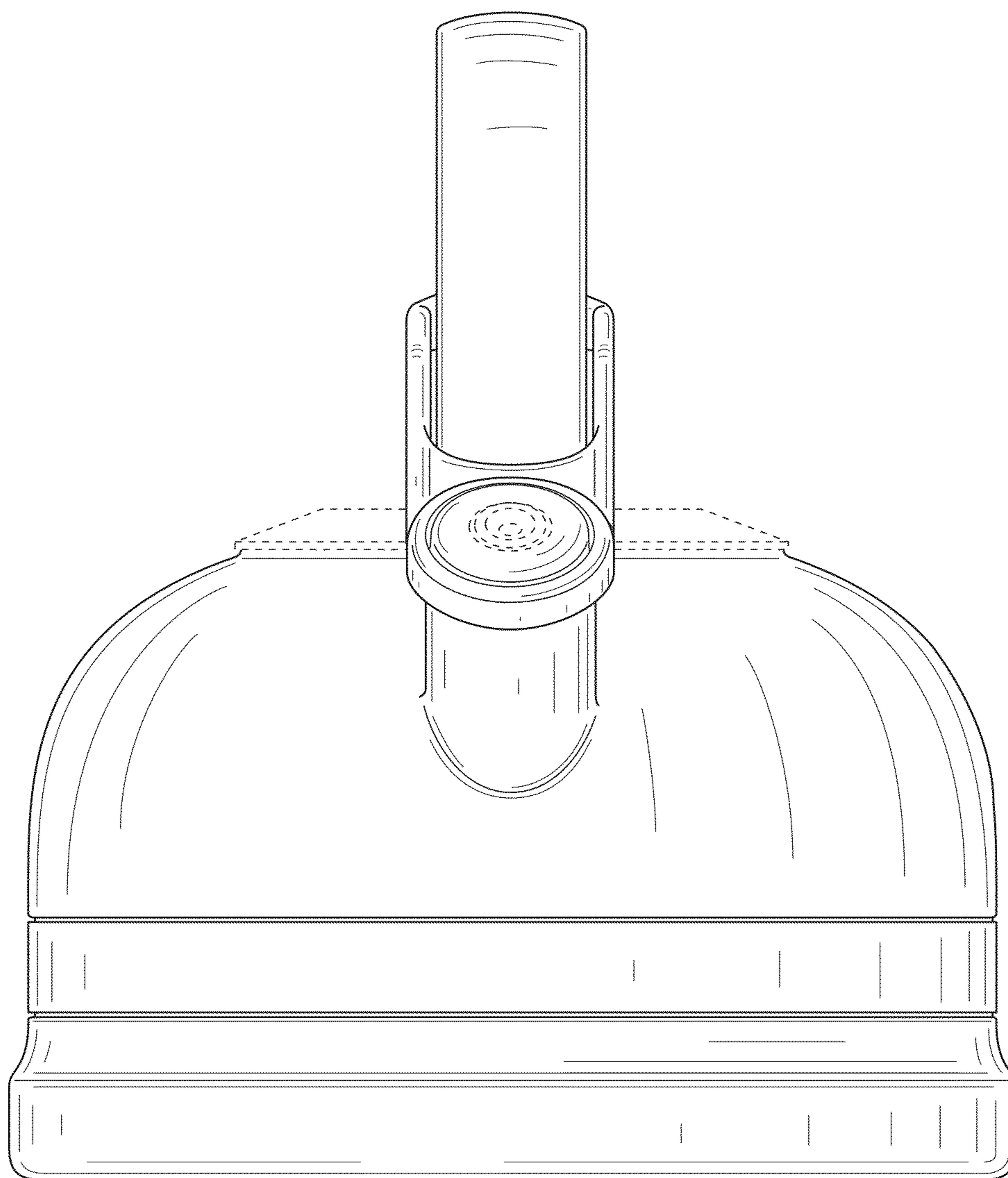

FIG. 18

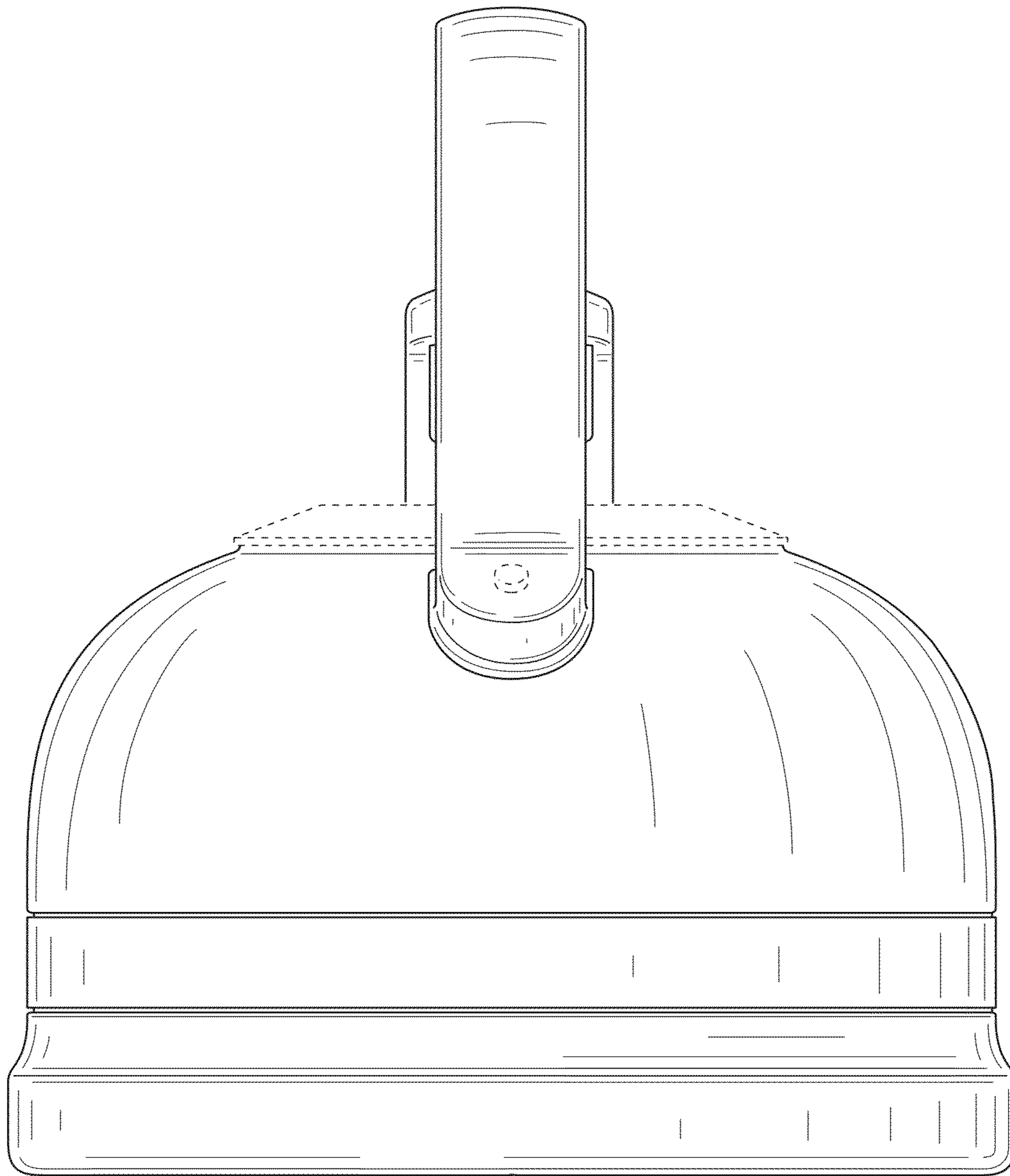

FIG. 19

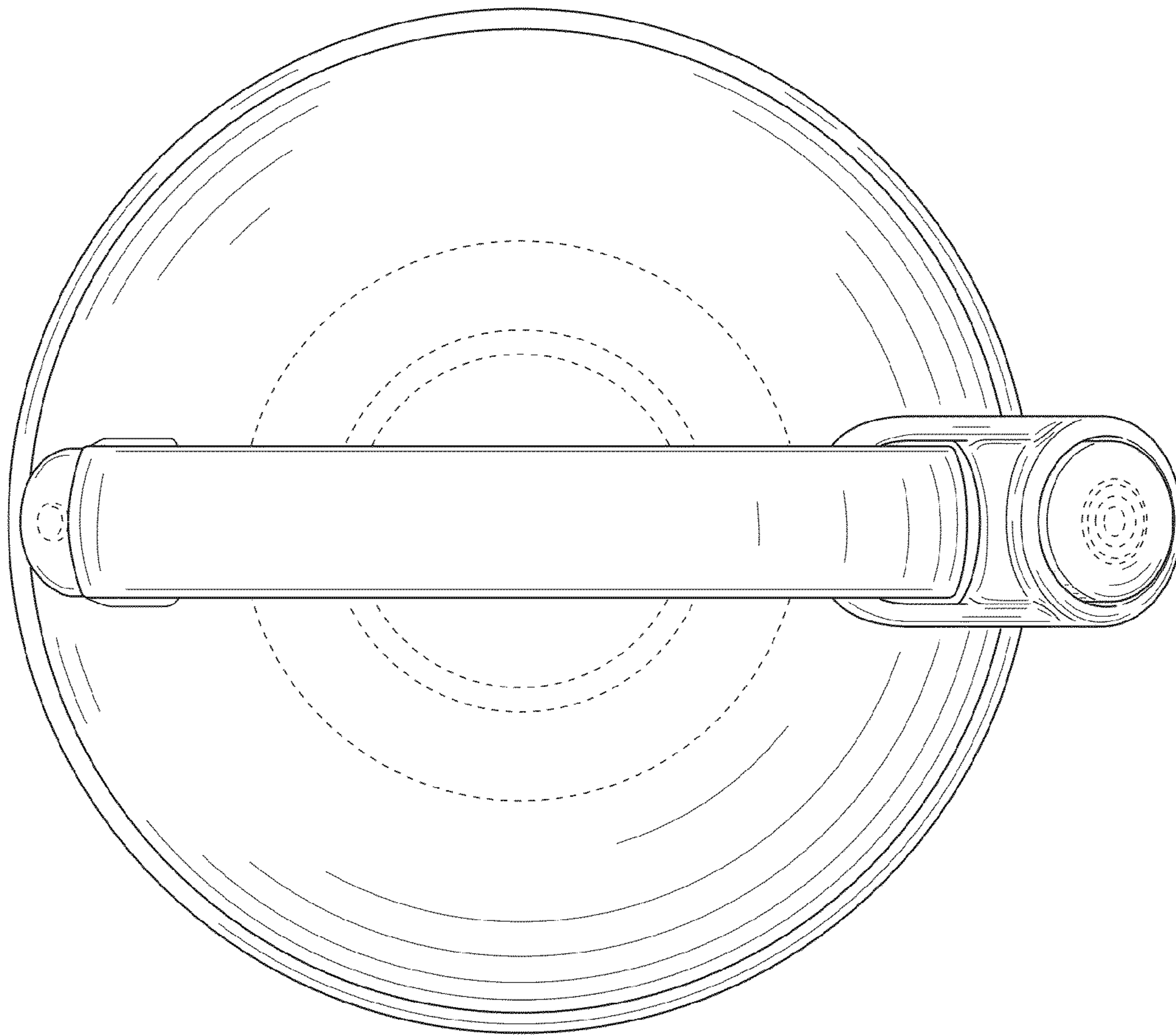

FIG. 20

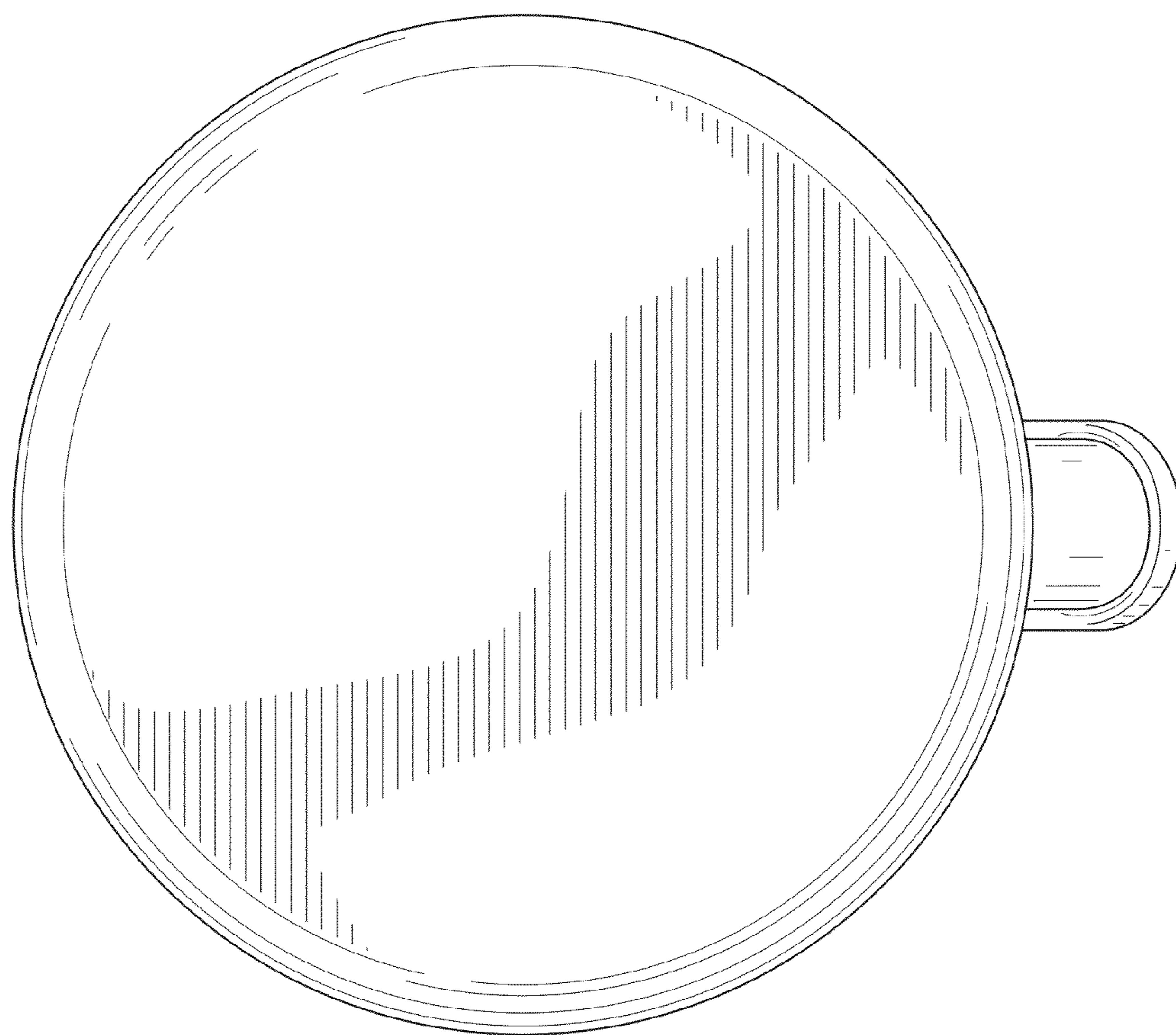

FIG. 21