



US00D713620S

(12) **United States Design Patent**
Pezzimenti et al.

(10) **Patent No.:** **US D713,620 S**
(45) **Date of Patent:** **** Sep. 23, 2014**

(54) **JACKET**

(71) Applicant: **NIKE, Inc.**, Beaverton, OR (US)

(72) Inventors: **Luke A. Pezzimenti**, Portland, OR (US);
Scott K. Hutsepiller, Portland, OR (US)

(73) Assignee: **NIKE, Inc.**, Beaverton, OR (US)

(**) Term: **14 Years**

(21) Appl. No.: **29/483,569**

(22) Filed: **Feb. 28, 2014**

(51) **LOC (10) Cl.** **02-02**

(52) **U.S. Cl.**
USPC **D2/828**

(58) **Field of Classification Search**
USPC D2/728, 750, 828, 829, 830, 839, 853;
2/93, 95, 97, 102, 108, DIG. 1
See application file for complete search history.

(56) **References Cited**

U.S. PATENT DOCUMENTS

1,657,866	A *	1/1928	Mooney	2/462
D113,204	S *	1/1939	Zucker et al.	D2/833
D115,592	S *	7/1939	Shapiro	D2/839
D139,535	S	11/1944	Bauer	
2,669,721	A *	2/1954	Koch	2/88
D194,967	S	4/1963	Bauer	
3,398,406	A *	8/1968	Waterbury	2/2.5
3,883,914	A *	5/1975	Blair	441/112
3,988,780	A *	11/1976	Armellino	2/2.5
4,084,264	A *	4/1978	Marion	2/459
4,149,272	A *	4/1979	Maeshima	
D255,056	S *	5/1980	Parsons	D29/101.3
4,602,387	A *	7/1986	Zakrzewski	2/102
4,619,622	A *	10/1986	McDonald et al.	441/111
D298,474	S *	11/1988	Twede	D29/100
5,465,424	A *	11/1995	Cudney et al.	2/462

D625,078	S	10/2010	Scott-Curran	
D631,230	S *	1/2011	Ruffini	D2/828
D638,200	S	5/2011	Gorson	
D642,770	S	8/2011	Bengyak	
D654,659	S	2/2012	Scott-Curran	
D656,301	S	3/2012	Randall	
D675,400	S	2/2013	Mertes	
D685,159	S	7/2013	Lambertz	
D698,526	S *	2/2014	Roberts et al.	D2/839
D698,528	S *	2/2014	Roberts et al.	D2/839
2004/0153012	A1 *	8/2004	Schroeder	601/19

OTHER PUBLICATIONS

Nike Apparel Catalog, 2010 Fall ACG, p. 4, published 2010, NIKE, Inc., USA.
Nike Apparel Catalog, 2010 Fall Apparel, p. 17, published 2010, NIKE, Inc., USA.

(Continued)

Primary Examiner — Rashida Johnson
(74) *Attorney, Agent, or Firm* — Banner & Witcoff, Ltd.

(57) **CLAIM**
The ornamental design for a jacket, as shown and described.

DESCRIPTION

FIG. 1 is a left perspective front view of a jacket showing my new design in an in-use configuration;
FIG. 2 is front view thereof;
FIG. 3 is a right side view thereof;
FIG. 4 is a left side view thereof;
FIG. 5 is a top view thereof; and,
FIG. 6 is an enlarged view of FIG. 2 showing the claimed area in isolation from the environment.
The broken lines immediately adjacent to the shaded area represent unclaimed boundaries of the design. The broken lines showing the remainder of the jacket are for environmental purposes only and form no part of the claimed design.

1 Claim, 5 Drawing Sheets

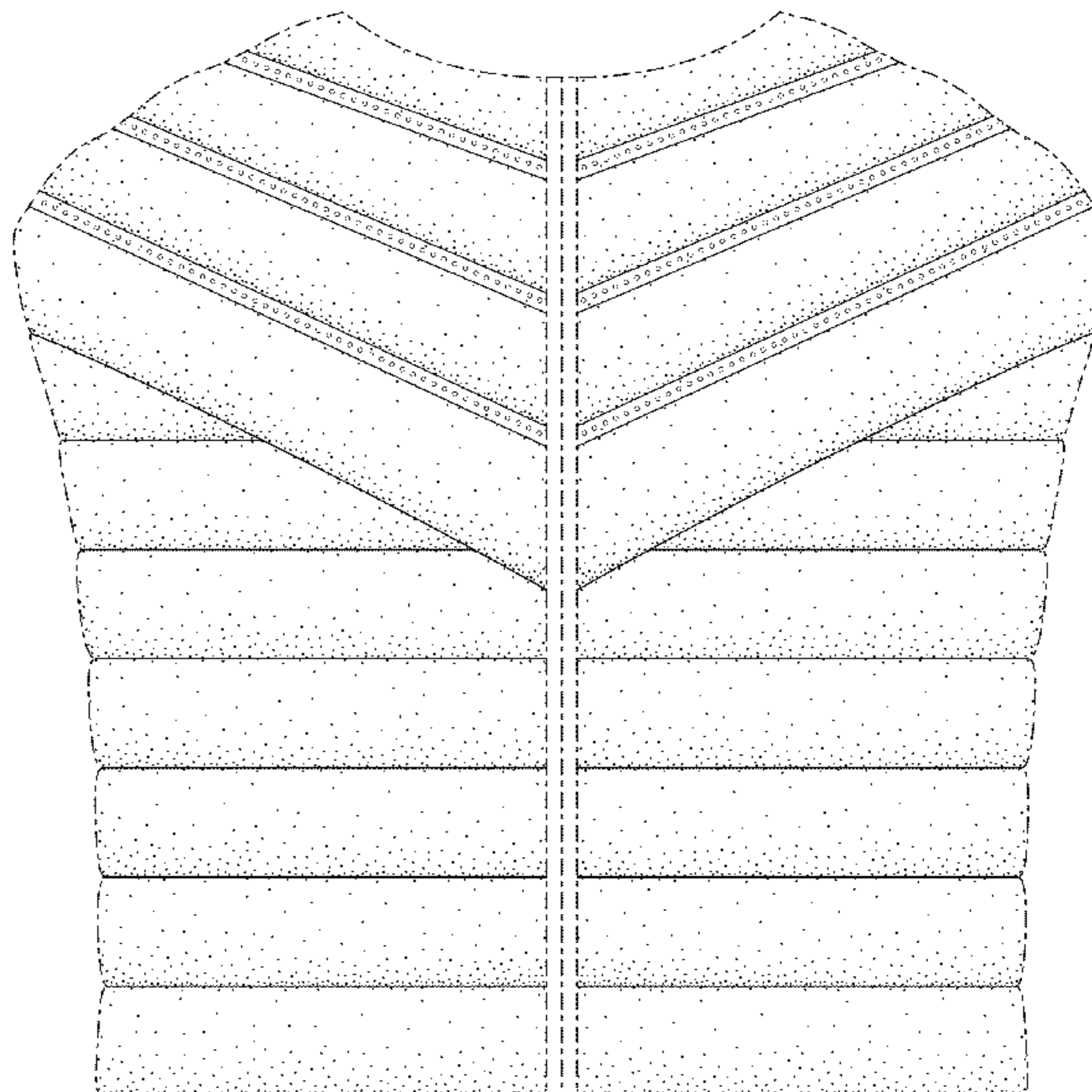
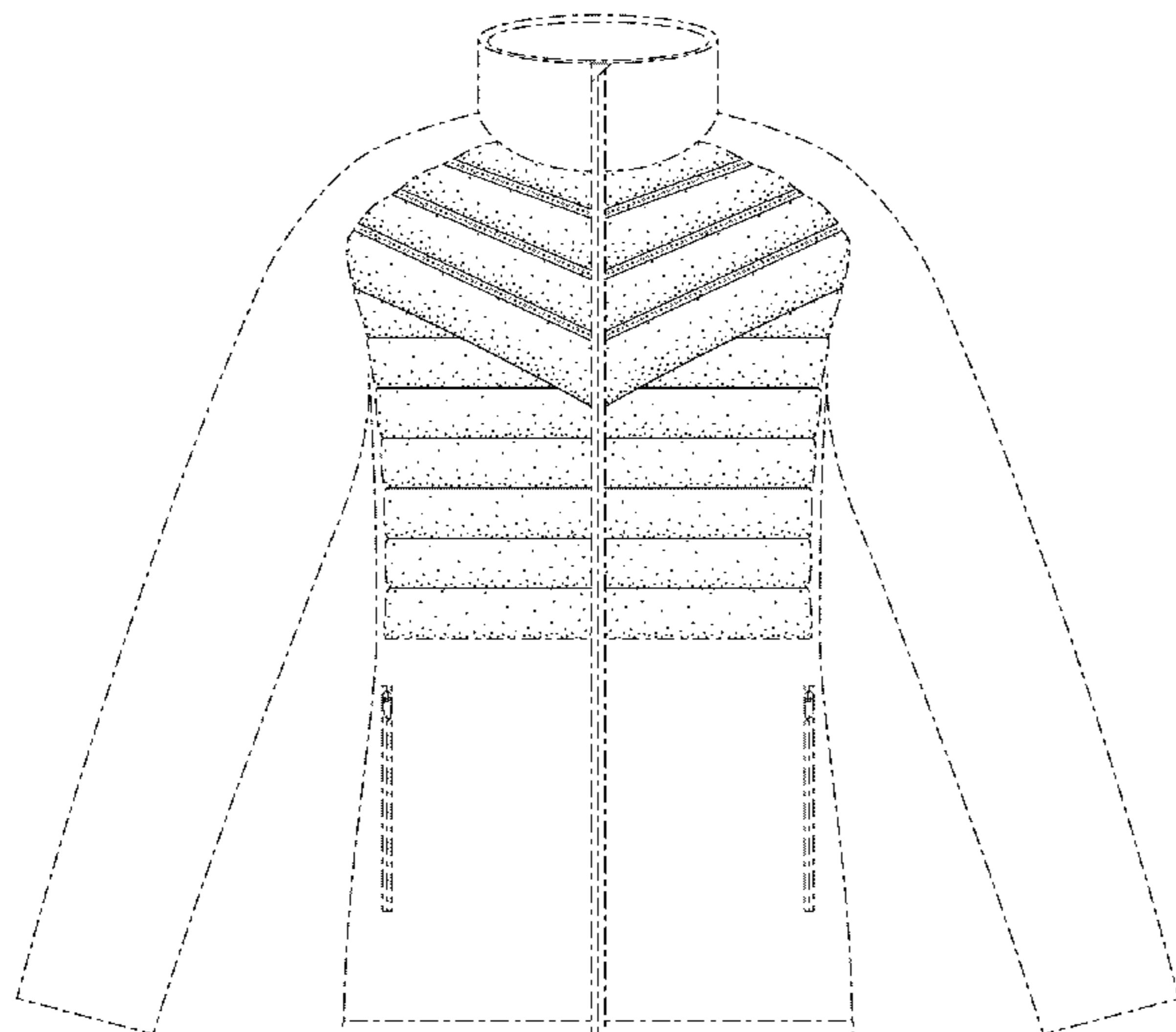

(56)

References Cited

OTHER PUBLICATIONS

Nike Apparel Catalog, 2010 Holiday Women's Athletic Department Classics, p. 9, published 2010, NIKE, Inc., USA.

Nike Apparel Catalog, 2011 Fall Boys' Apparel, p. 22, published 2011, NIKE, Inc., USA.

Nike Apparel Catalog, 2011 Fall Girls' Apparel, p. 8, published 2011, NIKE, Inc., USA.

Nike Apparel Catalog, 2011 Fall Men's Athletic Department Classics, p. 57, published 2011, NIKE, Inc., USA.

* cited by examiner

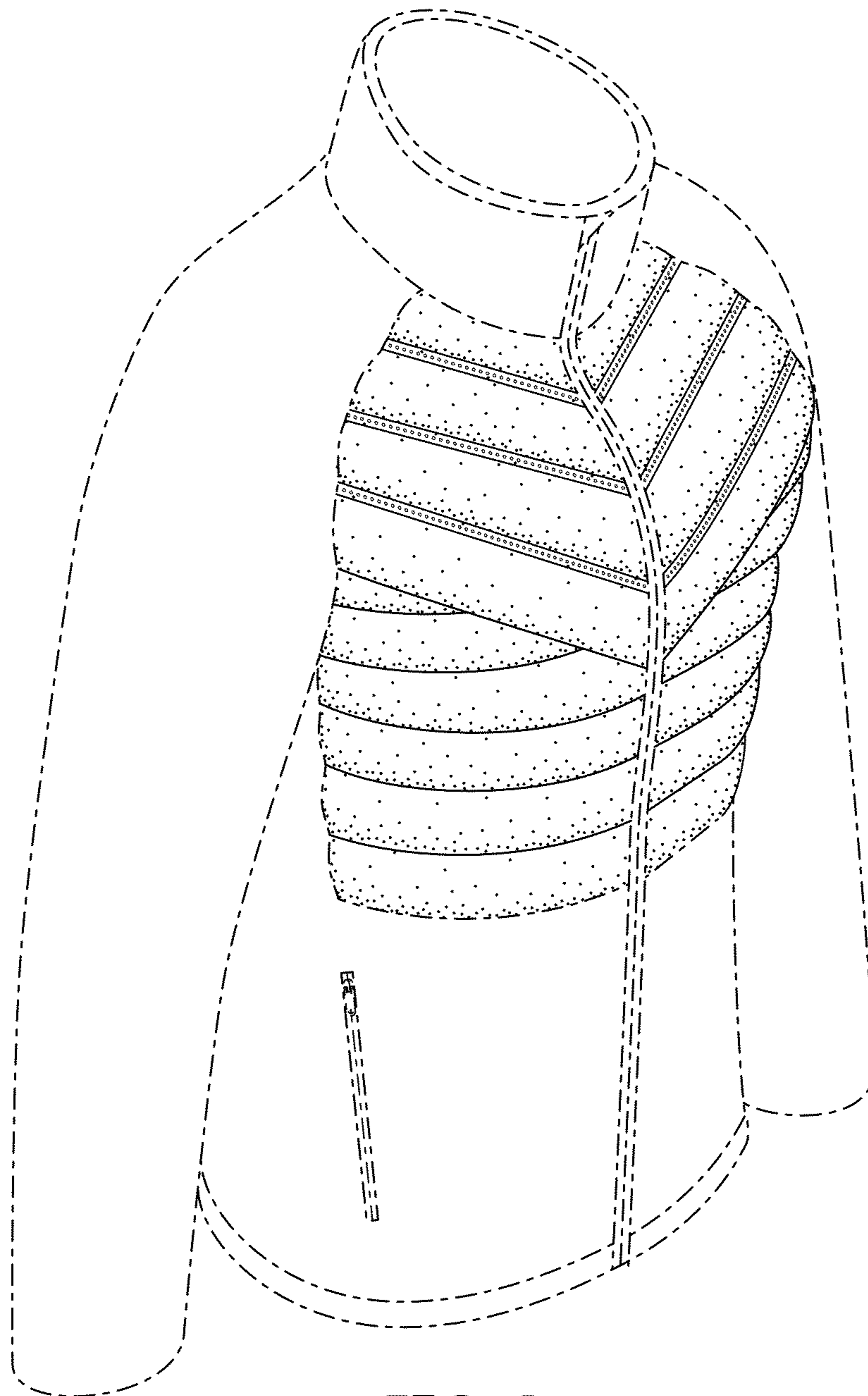

FIG. 1

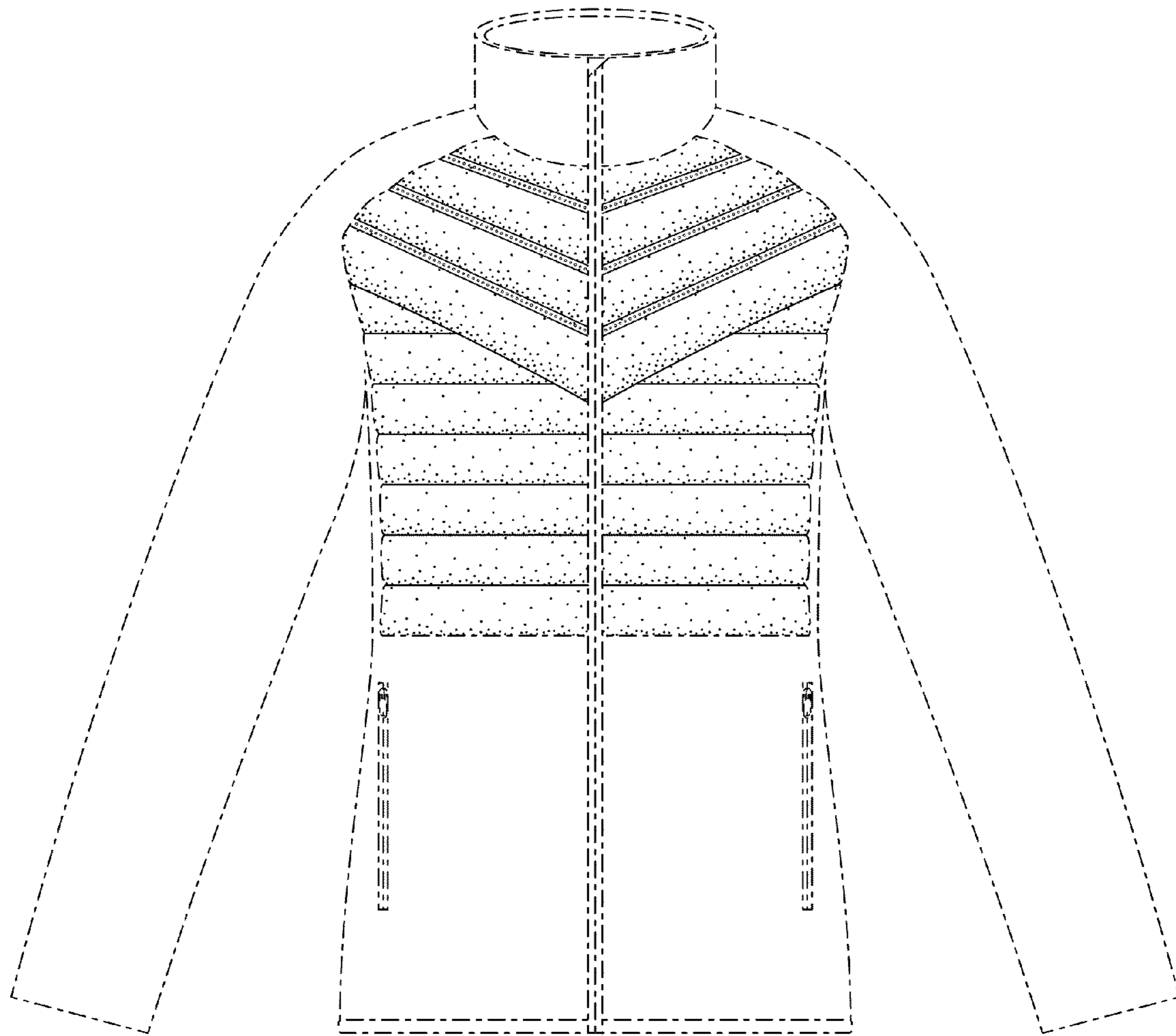

FIG. 2

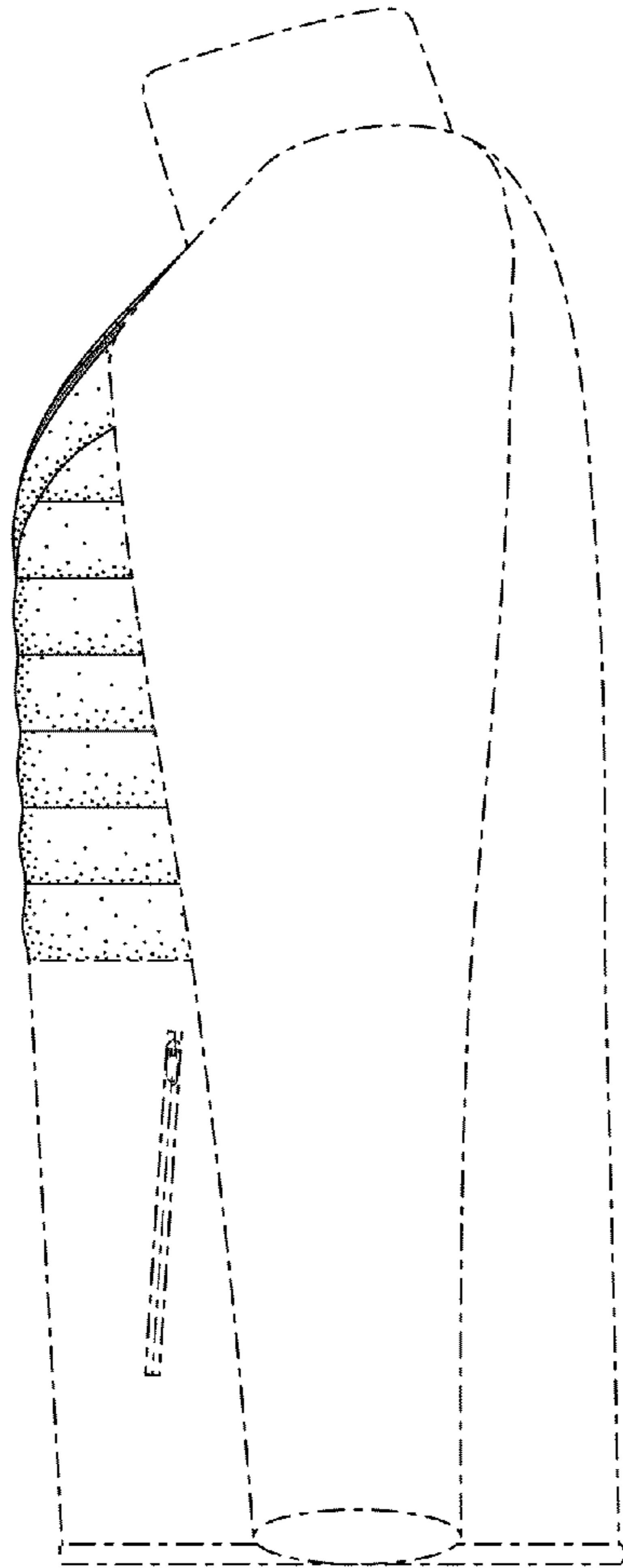

FIG. 3

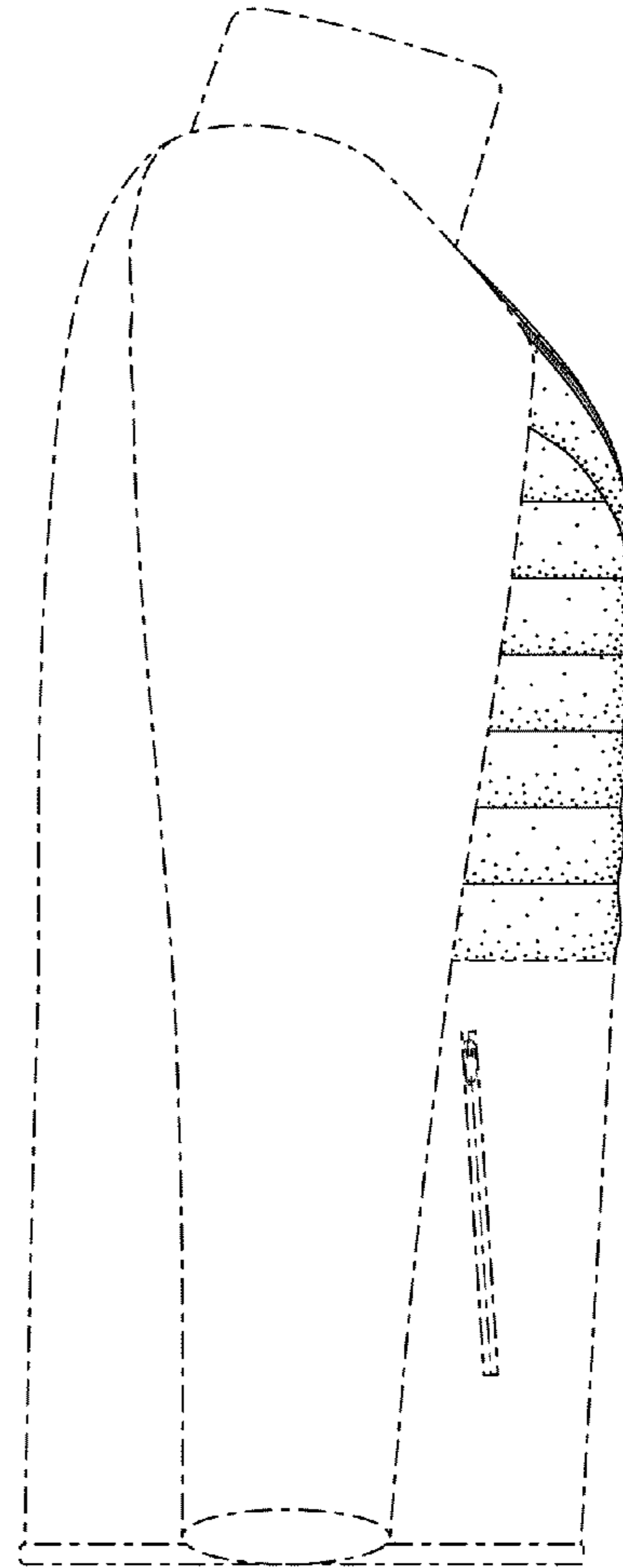

FIG. 4

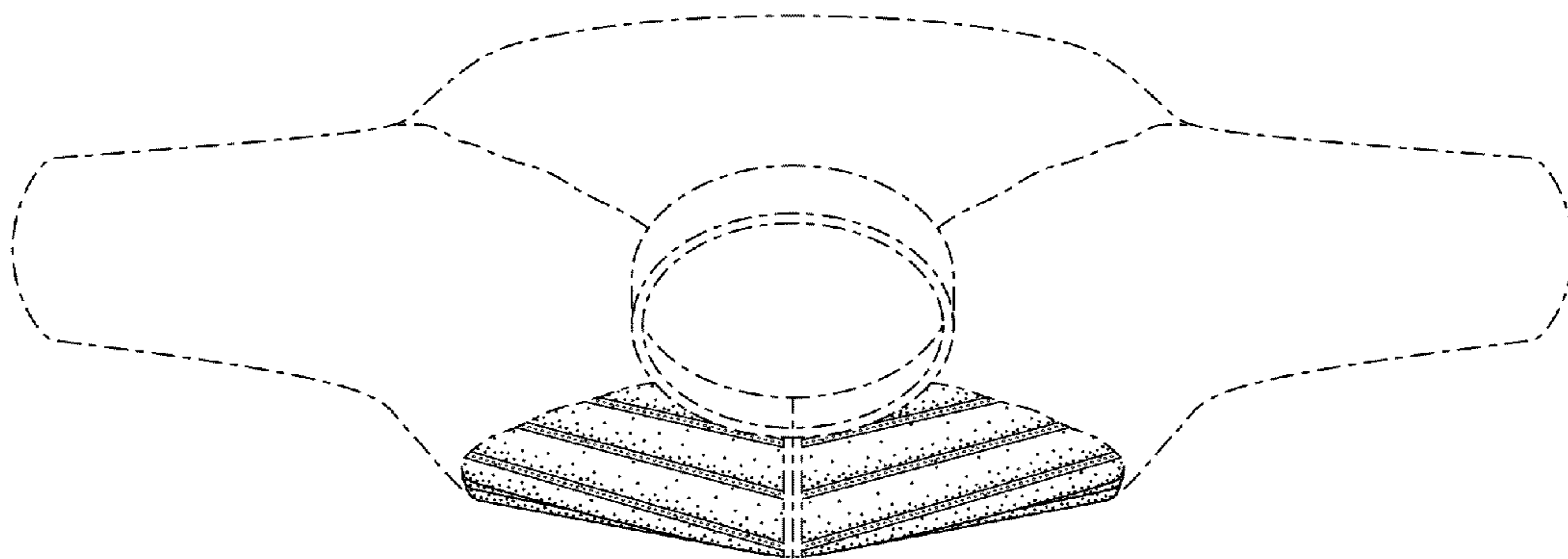

FIG. 5

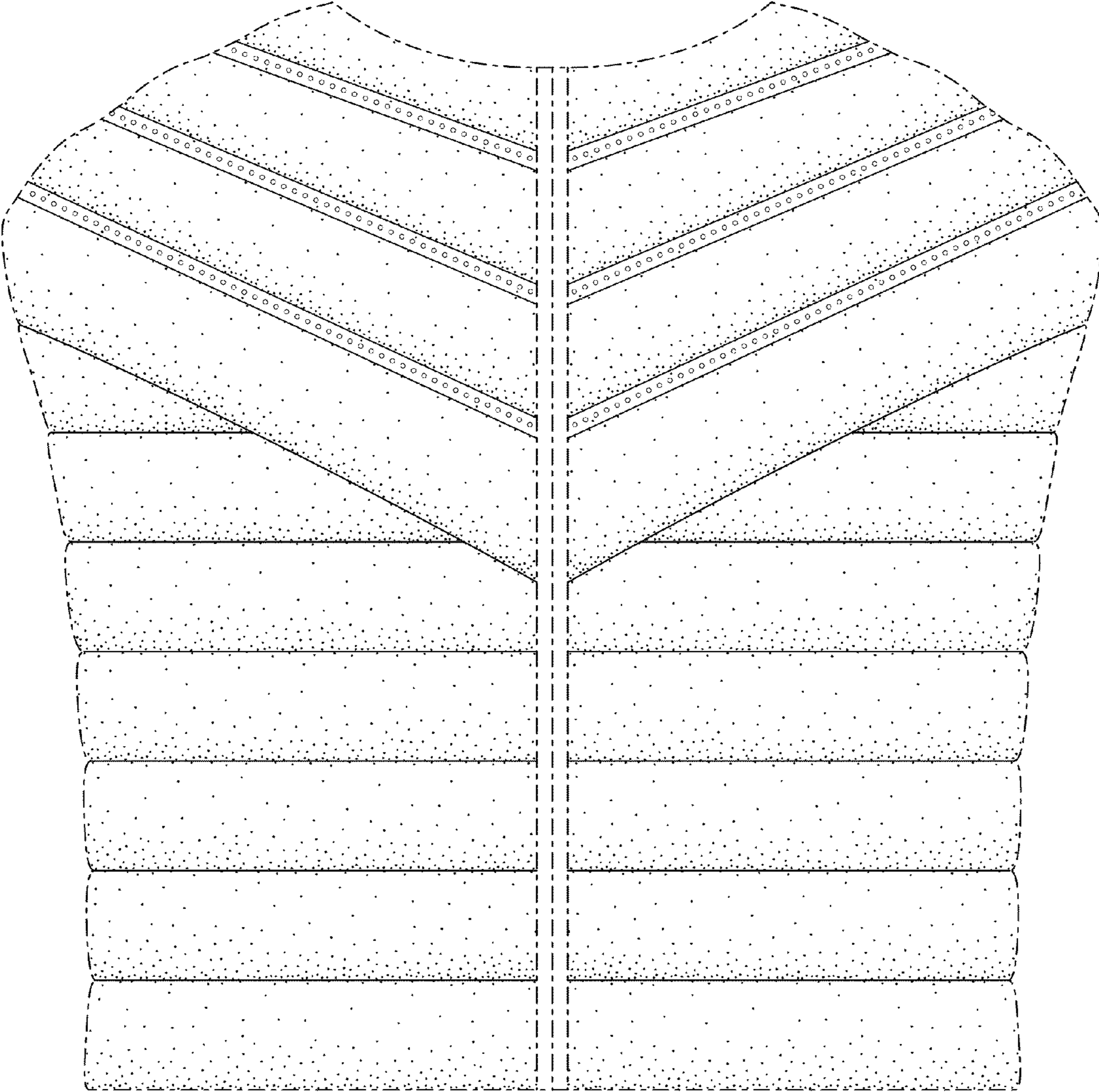

FIG. 6