



US00D713556S

(12) **United States Design Patent**
Stankay

(10) **Patent No.:** **US D713,556 S**

(45) **Date of Patent:** **** Sep. 16, 2014**

(54) **WINDOW FRAME EXTRUSION**

(56) **References Cited**

(71) Applicant: **Chelsea Building Products, Inc.,**
Oakmont, PA (US)

(72) Inventor: **Eric Stankay,** Gibsonia, PA (US)

(73) Assignee: **Chelsea Building Products, Inc.,**
Oakmont, PA (US)

(**) Term: **14 Years**

(21) Appl. No.: **29/443,980**

(22) Filed: **Jan. 24, 2013**

(51) **LOC (10) Cl.** **25-01**

(52) **U.S. Cl.**
USPC **D25/124**

(58) **Field of Classification Search**
USPC D25/124, 125; 52/204.1, 204.2, 204.5,
52/204.51, 656.5, 656.6, 213, 215, 208,
52/206, 212, 717.01, 209, 204.72, 579,
52/793.1, 794.1, 216, 204.55, 656.2,
52/656.7; 49/DIG. 2, 504, 501, 449, 180,
49/183, 505

See application file for complete search history.

U.S. PATENT DOCUMENTS

4,259,813 A * 4/1981 Winner et al. 49/504
6,334,283 B1 * 1/2002 Edger 52/204.1
D591,430 S * 4/2009 Campbell et al. D25/124

* cited by examiner

Primary Examiner — Doris Clark

(74) *Attorney, Agent, or Firm* — Drinker Biddle & Reath
LLP

(57) **CLAIM**

The ornamental design for a window frame extrusion, as shown and described.

DESCRIPTION

FIG. 1 is a perspective view of a patio door frame extrusion according to the present invention, the broken edge indicating that the length of the extrusion continues.

FIG. 2 is a left side view of the window frame extrusion of FIG. 1.

FIG. 3 is a right side view of the window frame extrusion of FIG. 1.

FIG. 4 is a top view of the window frame extrusion of FIG. 1.

FIG. 5 is a bottom view of the window frame extrusion of FIG. 1.

FIG. 6 is a front plan view of the window frame extrusion of FIG. 1; and,

FIG. 7 is a rear plan view of the window frame extrusion of FIG. 1.

The portions of the design shown in dashed lines do not form a part of the claimed invention.

1 Claim, 4 Drawing Sheets

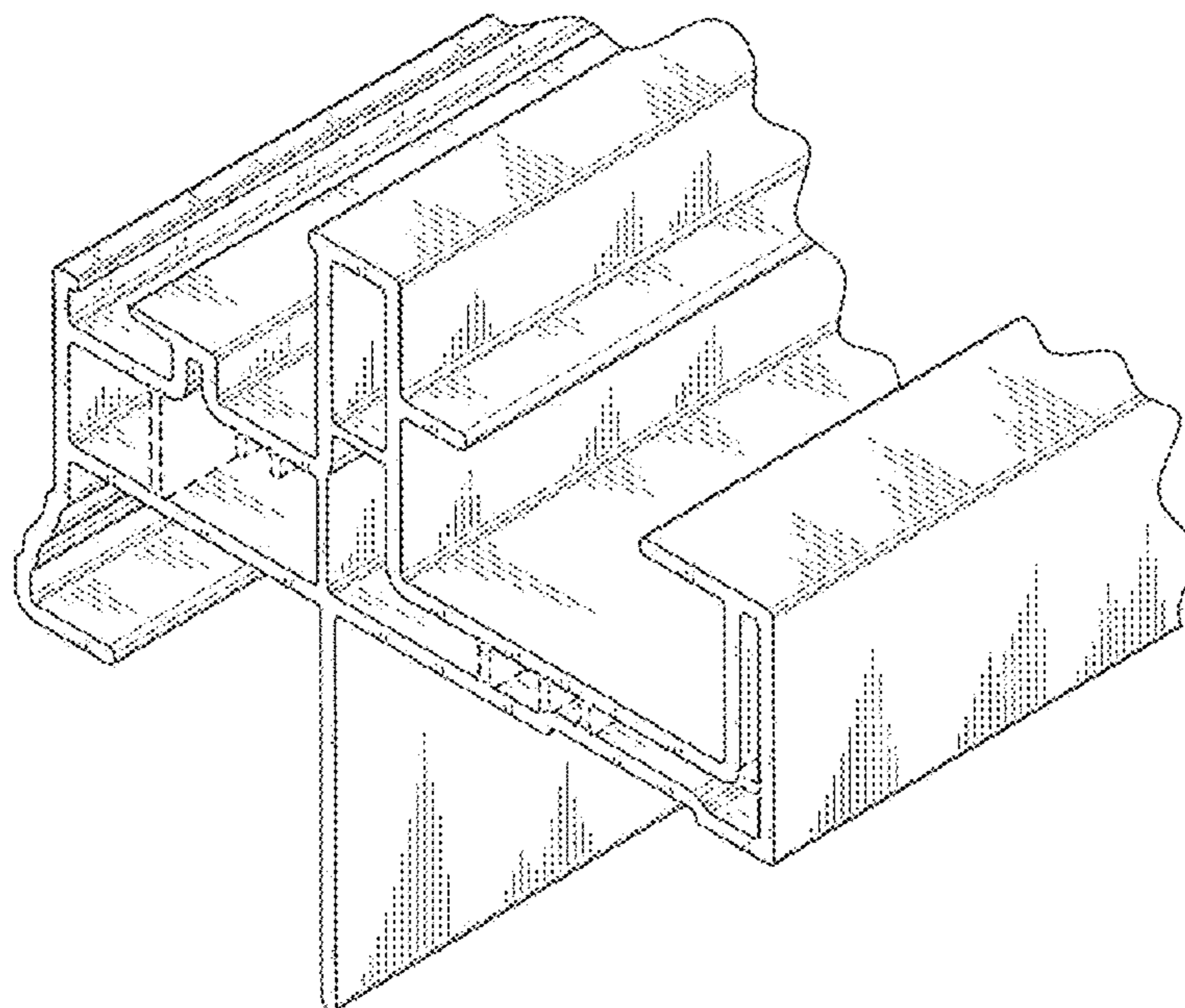

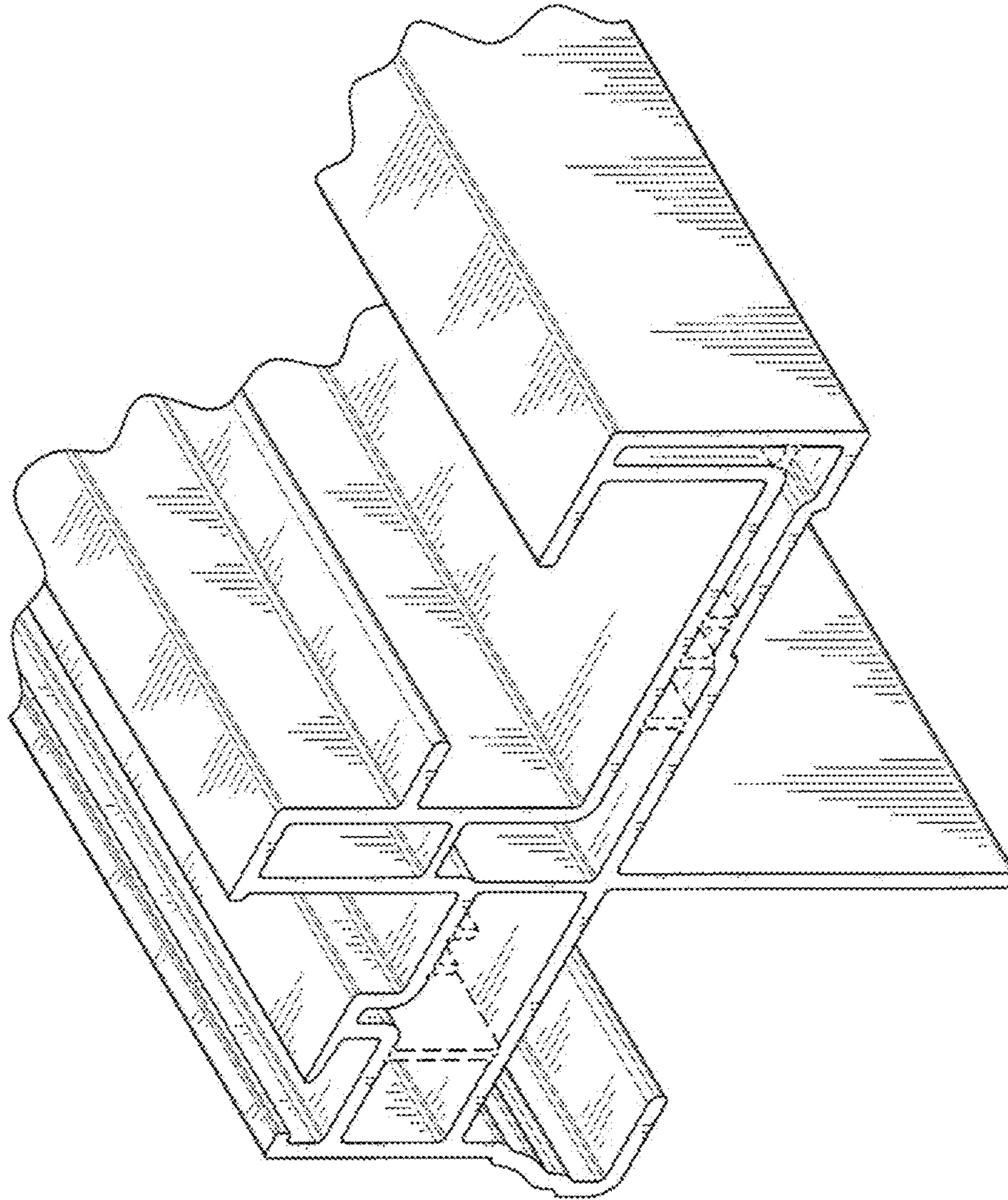

FIG. 1

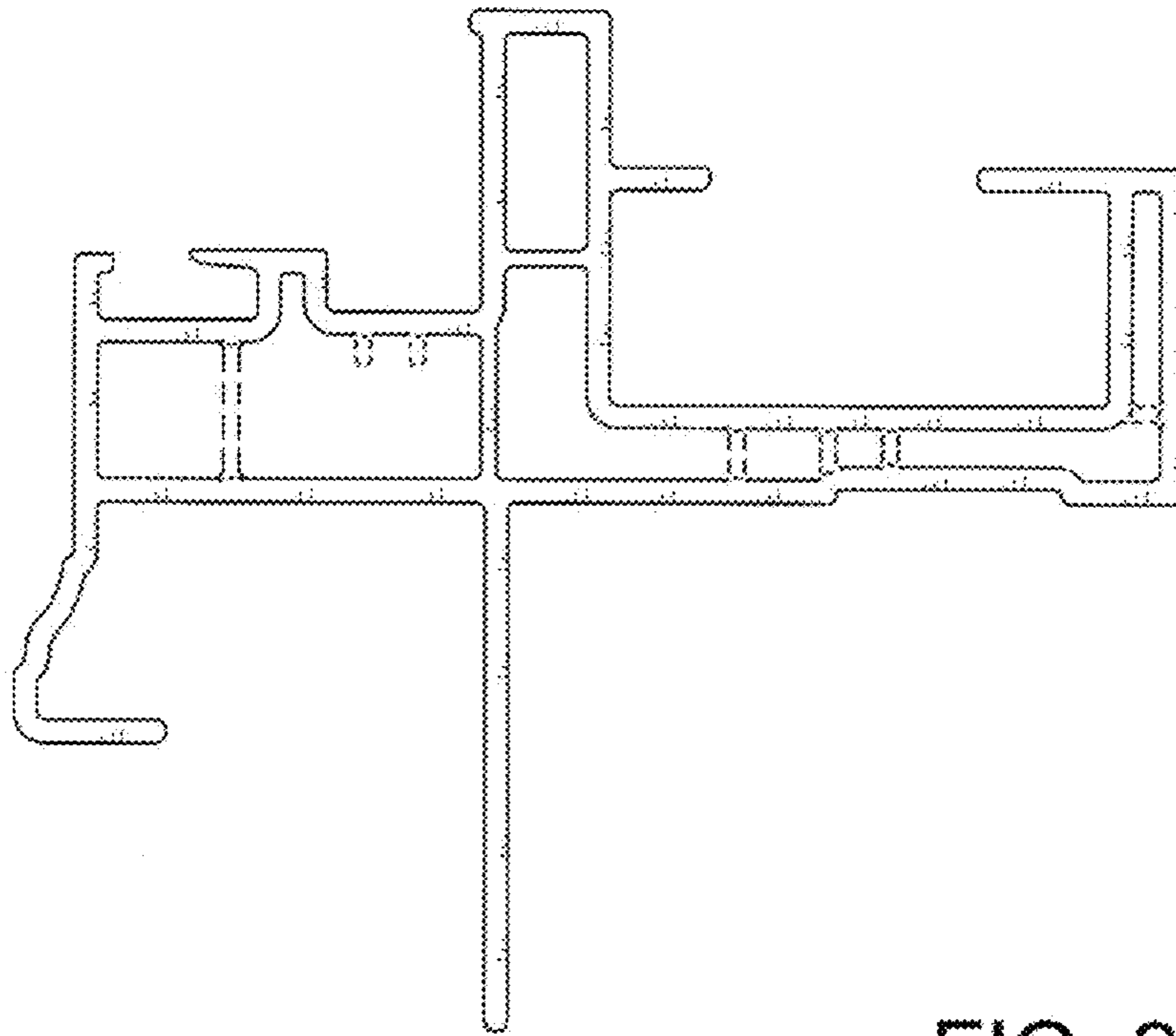

FIG. 2

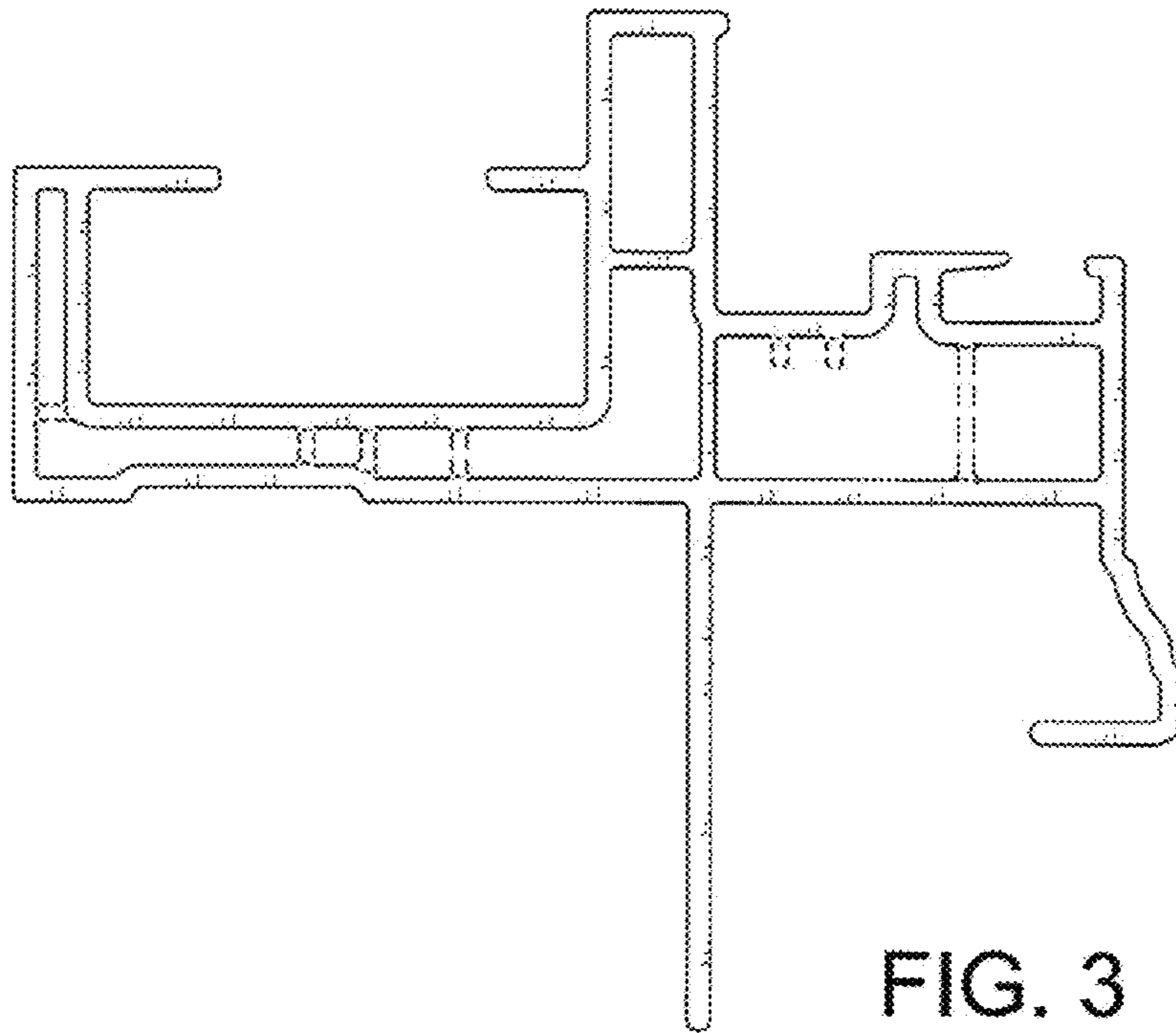

FIG. 3

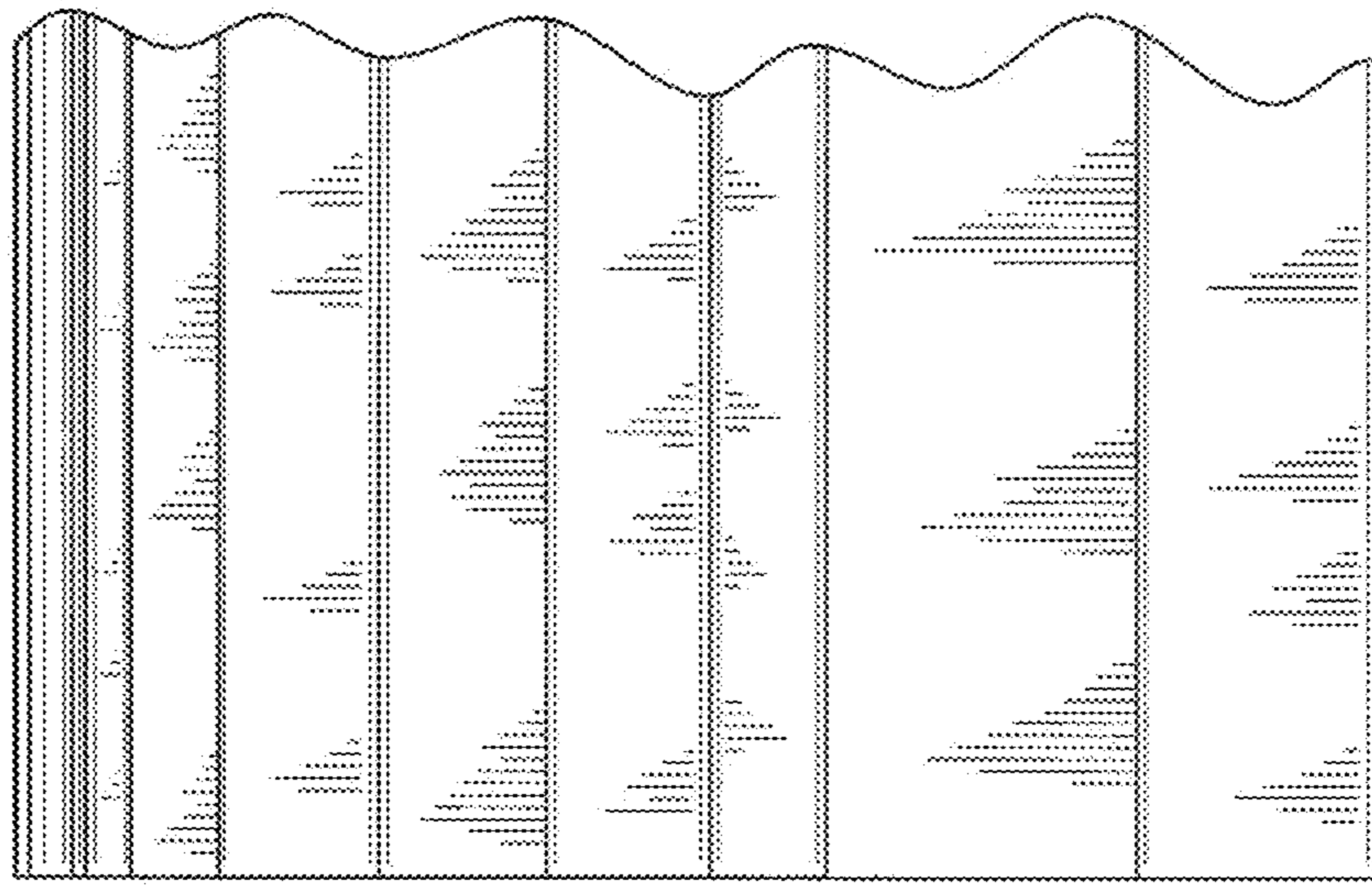

FIG. 4

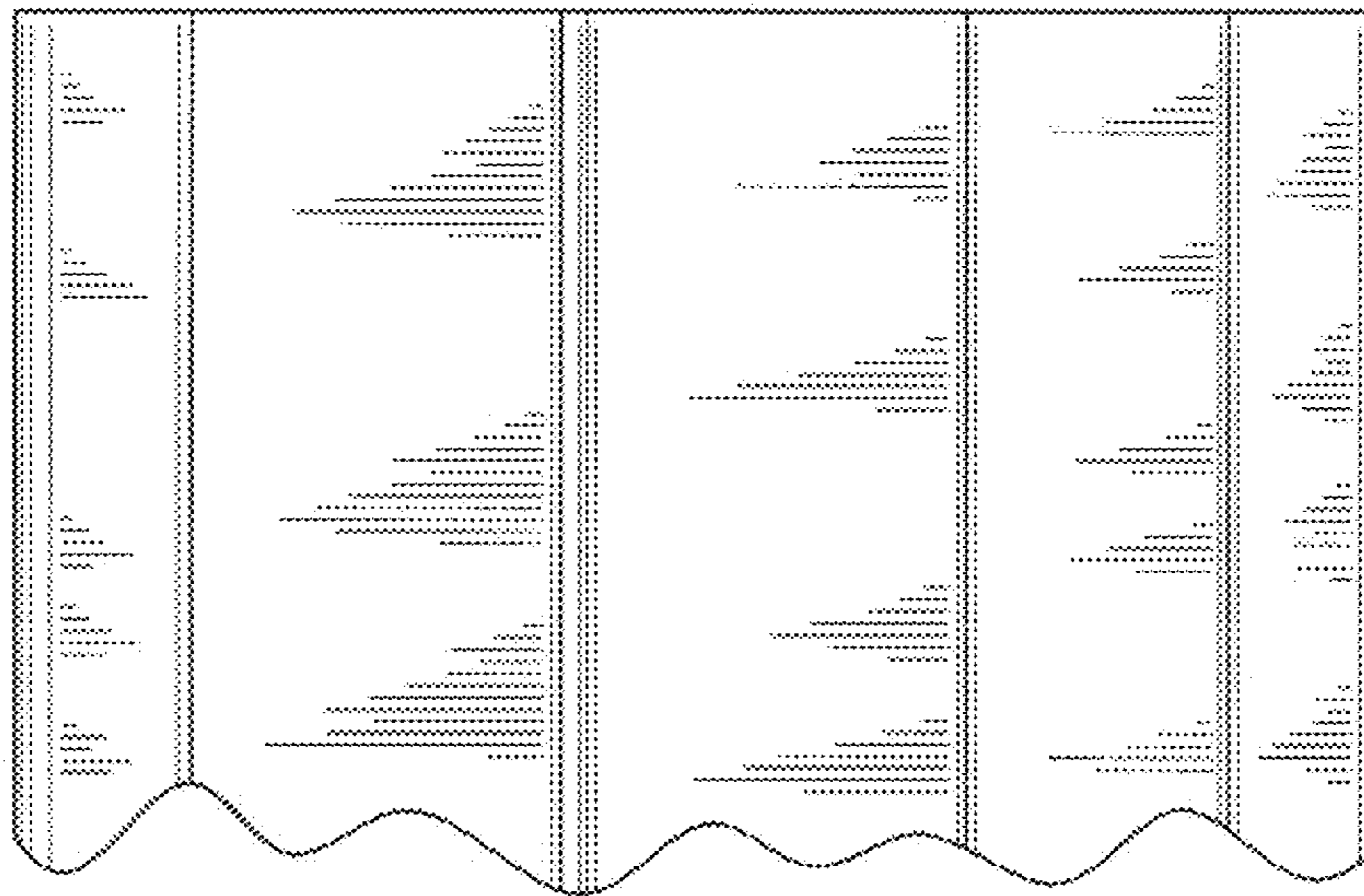

FIG. 5

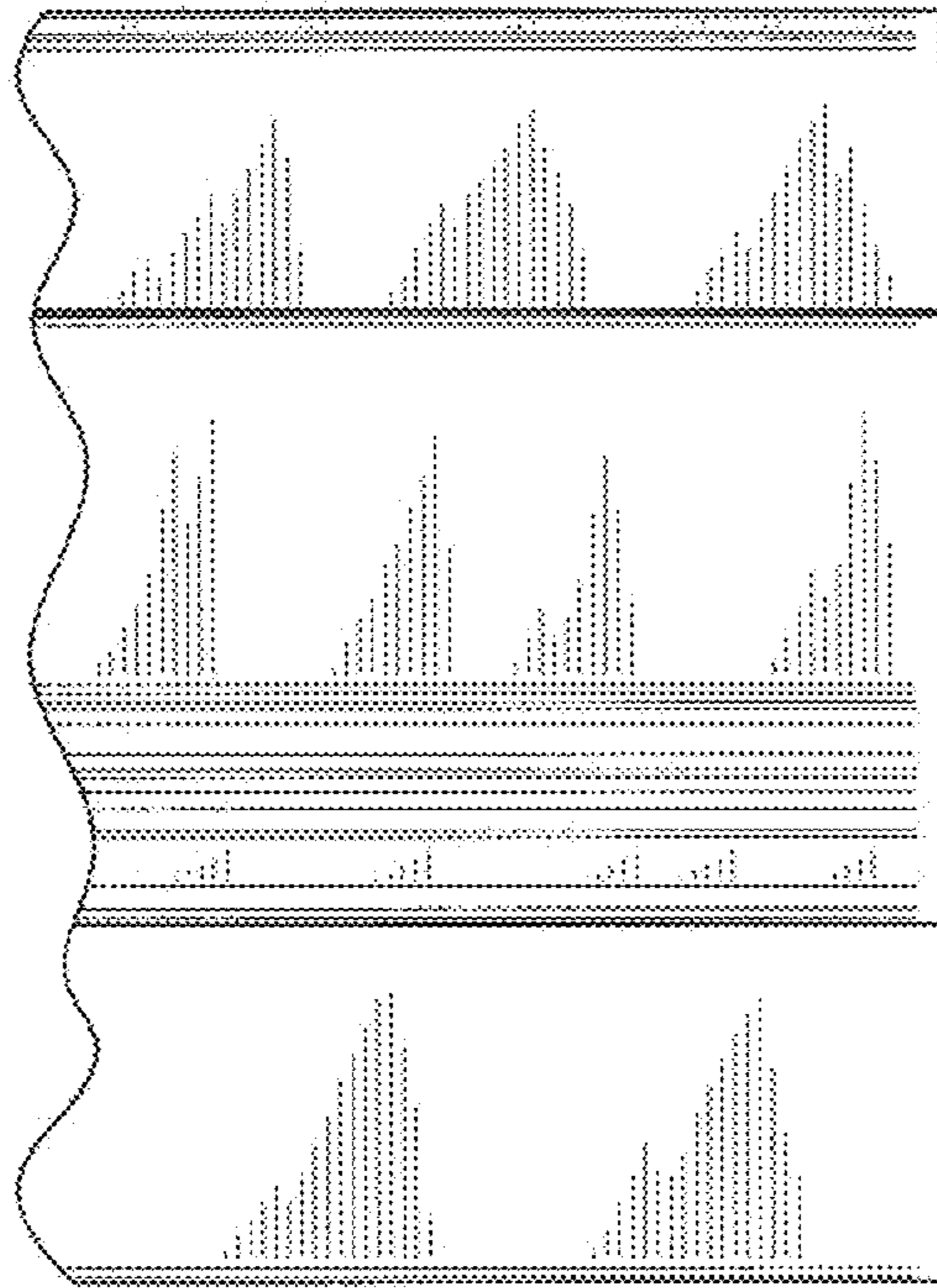

FIG. 6

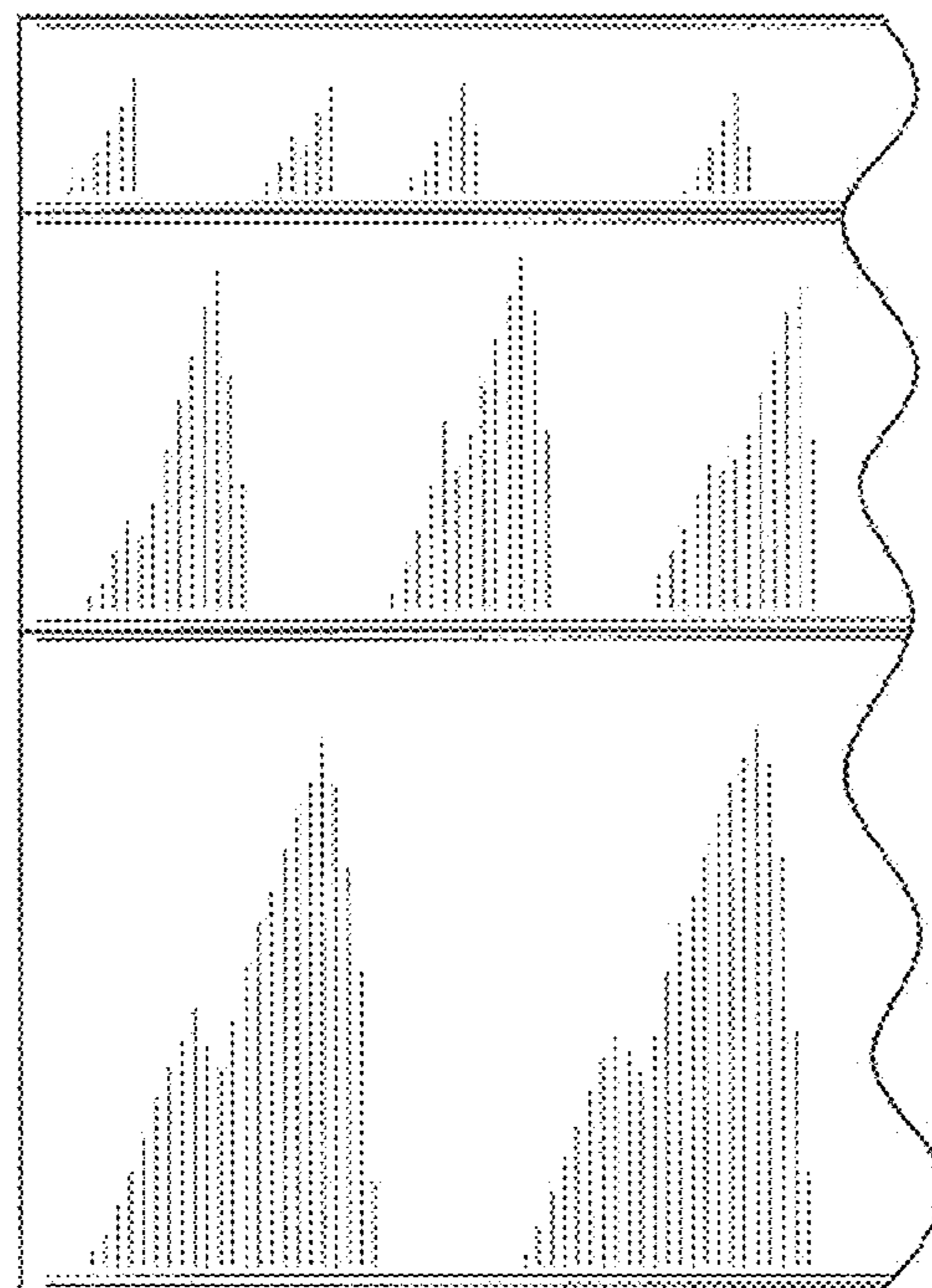

FIG. 7