



US00D713508S

(12) **United States Design Patent**
Downey et al.

(10) **Patent No.:** **US D713,508 S**
(45) **Date of Patent:** **** Sep. 16, 2014**

- (54) **FAUCET**
- (71) Applicant: **Price Pfister, Inc.**, Lake Forest, CA (US)
- (72) Inventors: **David R. Downey**, Mission Viejo, CA (US); **Aaron Hanna**, Corona, CA (US)
- (73) Assignee: **Price Pfister, Inc.**, Lake Forest, CA (US)
- (**) Term: **14 Years**
- (21) Appl. No.: **29/482,826**
- (22) Filed: **Feb. 21, 2014**
- (51) **LOC (10) Cl.** **23-01**
- (52) **U.S. Cl.**
USPC **D23/238**
- (58) **Field of Classification Search**
CPC E03C 1/04; E03C 1/0401; E03C 1/0404;
E03C 1/0415
USPC D23/238, 241–243, 250, 252, 255, 257
See application file for complete search history.

- D481,445 S 10/2003 Haug et al.
- D488,210 S 4/2004 Lord
- D499,795 S 12/2004 Bayer
- D510,126 S 9/2005 Ouyoung
- 6,941,971 B1 9/2005 Hsien

(Continued)

FOREIGN PATENT DOCUMENTS

- DE 202005013467 U1 3/2006
- EP 1705297 B1 10/2008

(Continued)

Primary Examiner — Robert Delehanty

(74) *Attorney, Agent, or Firm* — Barnes & Thornburg LLP

(57) **CLAIM**

What is claimed is the ornamental design for a faucet, as shown and described.

DESCRIPTION

FIG. 1—perspective view of our new design with the spray head in broken lines;
 FIG. 2—right side elevation view of the design shown in FIG. 1;
 FIG. 3—is the left side elevational view of the design shown in FIG. 1;
 FIG. 4—is a top view of the design shown in FIG. 1;
 FIG. 5—is a bottom view of the design shown in FIG. 1;
 FIG. 6—is a front elevational view of the design shown in FIG. 1; and,
 FIG. 7—is a rear elevational view of the design shown in FIG. 1.

The broken lines shown in the drawings are for purposes of illustrating portions of the design and form no part of the claimed design.

1 Claim, 7 Drawing Sheets

(56) **References Cited**

U.S. PATENT DOCUMENTS

- D456,878 S 5/2002 Gottwald
- D457,938 S 5/2002 Lobermeier
- D457,939 S 5/2002 Gottwald
- D460,150 S 7/2002 Rexach
- D463,529 S 9/2002 Dretzka
- D468,397 S 1/2003 Czerwinski, Jr.
- D468,398 S 1/2003 Ziemann
- D469,157 S 1/2003 Lobermeier
- D470,224 S 2/2003 Hanna
- D472,961 S 4/2003 Ziemann
- D473,630 S 4/2003 Wettstein et al.
- D476,397 S 6/2003 Ouyoung
- D479,309 S 9/2003 Haug
- D479,310 S 9/2003 Ziemann
- D479,579 S 9/2003 Haug et al.

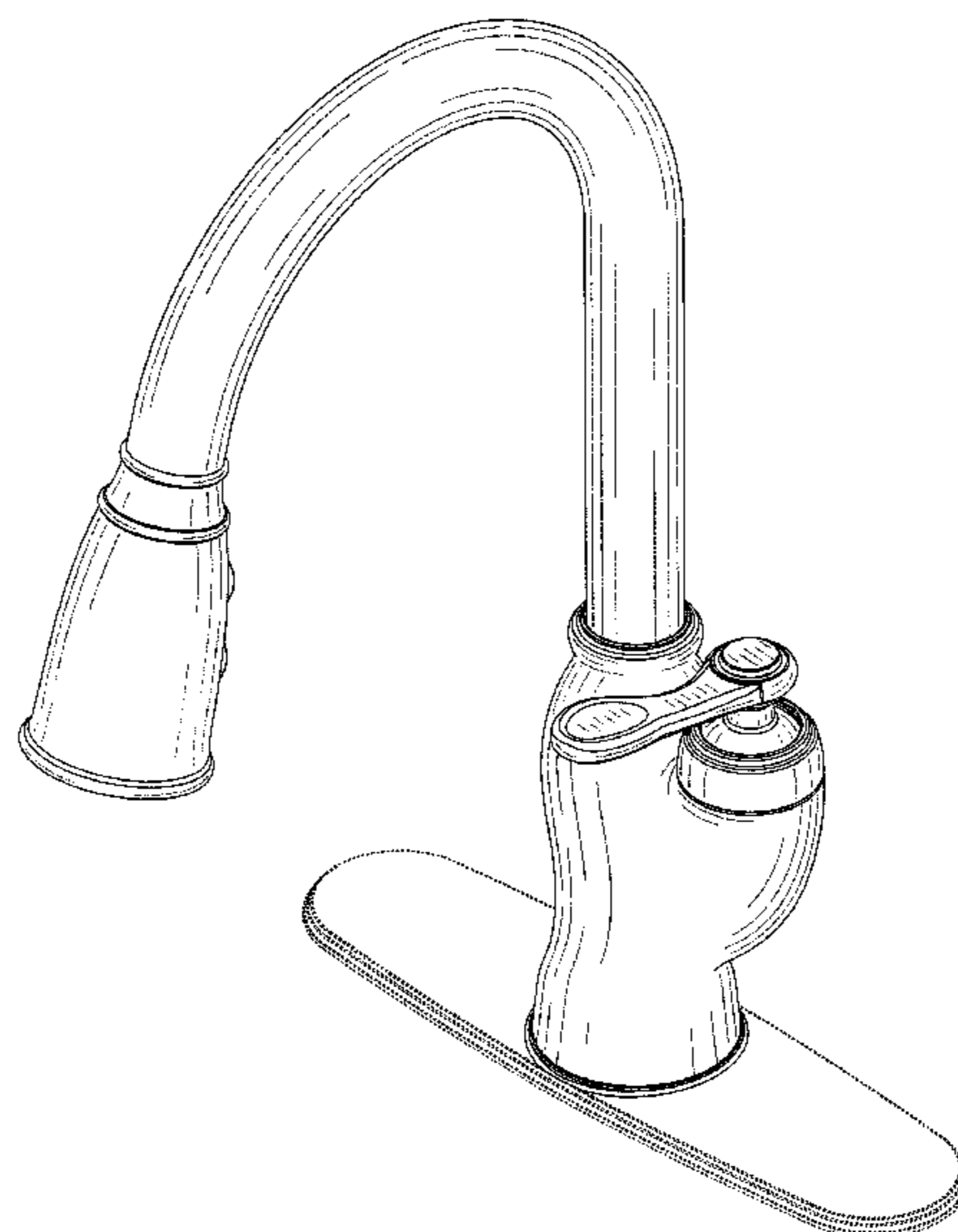

(56)

References Cited

U.S. PATENT DOCUMENTS

D511,560 S 11/2005 Kulig et al.
 D513,526 S 1/2006 Marshall
 D513,788 S 1/2006 Lindholm
 D514,665 S 2/2006 Lindholm
 D517,166 S 3/2006 Chu
 D517,652 S 3/2006 Egli et al.
 D519,190 S 4/2006 Lord
 D521,109 S 5/2006 Lord
 D527,075 S 8/2006 Wood et al.
 D531,698 S 11/2006 Wood et al.
 D532,483 S 11/2006 Lobermeier et al.
 D532,868 S 11/2006 Spangler et al.
 D532,869 S 11/2006 Lobermeier
 D534,246 S 12/2006 Chu et al.
 D534,621 S 1/2007 Chu et al.
 D534,622 S 1/2007 Chu et al.
 D535,357 S 1/2007 Zhou
 D535,724 S 1/2007 Zhou
 D537,146 S 2/2007 Hanna
 D539,870 S 4/2007 Lammel et al.
 D539,871 S 4/2007 Hanna
 D544,945 S 6/2007 Wood et al.
 D550,330 S 9/2007 Müllenmeister
 D564,075 S 3/2008 Williams
 D566,811 S 4/2008 Zhang
 D567,909 S 4/2008 Schonherr
 D575,375 S 8/2008 Williams
 D577,107 S 9/2008 Gilbert
 D580,017 S 11/2008 Yegyayan
 D583,021 S * 12/2008 Downey et al. D23/250
 D602,568 S 10/2009 Kwok
 D603,021 S 10/2009 Roy
 D609,780 S 2/2010 Fritz et al.
 D610,235 S 2/2010 Kwok
 D612,015 S 3/2010 Lammel et al.
 D620,558 S 7/2010 Krumpe

7,753,079 B2 7/2010 Nelson
 D625,391 S 10/2010 Soriano
 7,871,020 B2 1/2011 Nelson et al.
 D632,365 S 2/2011 Choi
 D642,661 S 8/2011 Corbett
 D645,121 S 9/2011 Fritz
 D645,122 S 9/2011 Fritz
 D645,937 S 9/2011 Sedwick
 D653,729 S 2/2012 Romero
 D653,730 S 2/2012 Bailey et al.
 D653,731 S 2/2012 Bailey
 D653,732 S 2/2012 Romero
 D658,744 S 5/2012 Starck
 D665,052 S 8/2012 Wang
 D665,876 S 8/2012 Corbett
 D665,877 S 8/2012 Fritz
 D667,933 S 9/2012 Kwok
 8,387,661 B2 * 3/2013 Nelson 137/801
 D684,242 S 6/2013 McKeone et al.
 D687,517 S 8/2013 Miles et al.
 D689,595 S 9/2013 Georgeson
 D693,905 S 11/2013 Ke et al.
 D693,906 S 11/2013 Zhang et al.
 D694,860 S 12/2013 McKeone et al.

FOREIGN PATENT DOCUMENTS

EP 2103749 A2 9/2009
 EP 1882785 B1 6/2011
 EP 1944418 B1 7/2012
 EP 1577448 B1 9/2013
 IT 1358175 B 3/2009
 WO WO2013154812 A1 10/2003
 WO WO2005098150 A2 10/2005
 WO WO2008086379 A1 7/2008
 WO WO2009120335 A1 10/2009
 WO WO2011075321 A1 6/2011

* cited by examiner

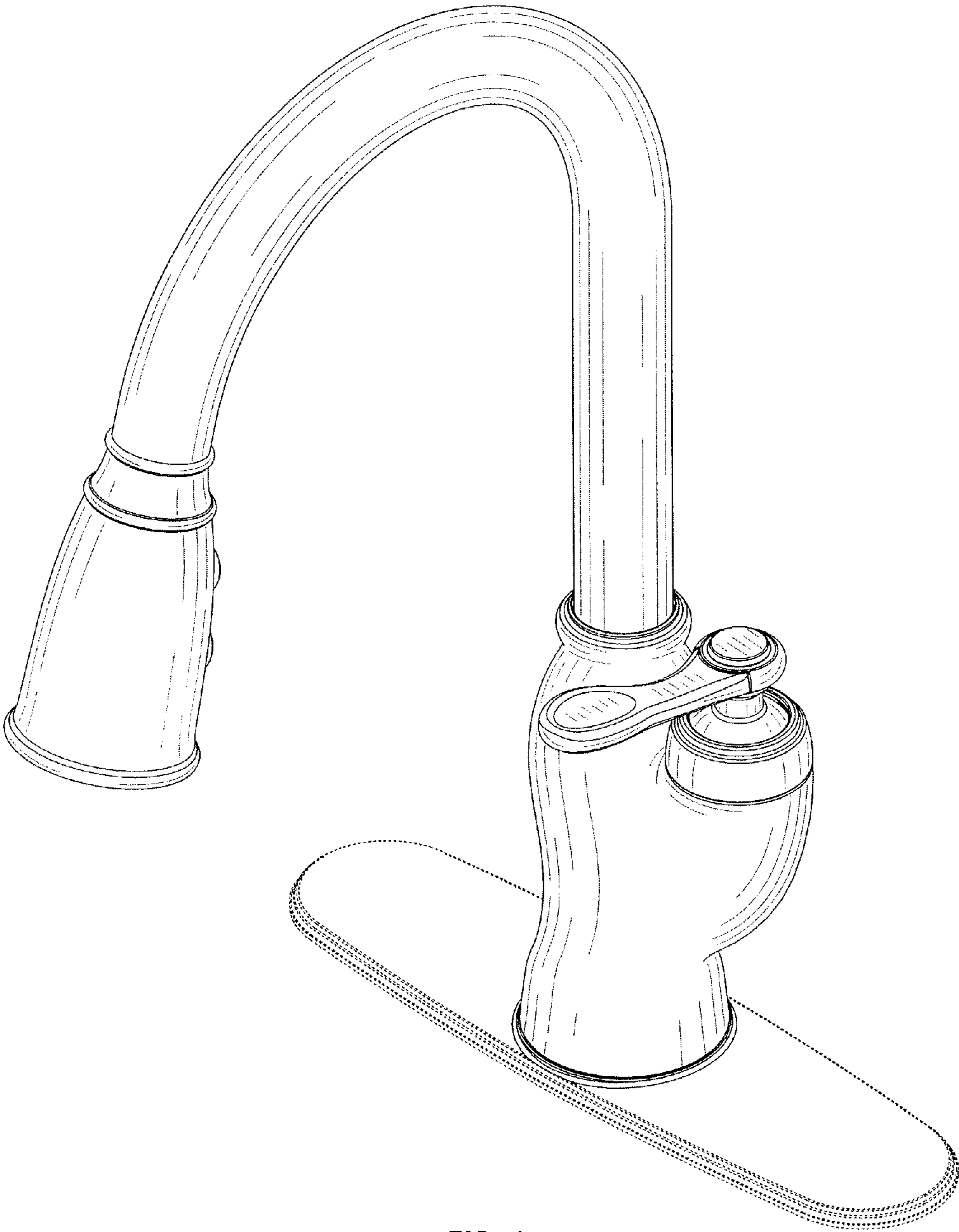

FIG. 1

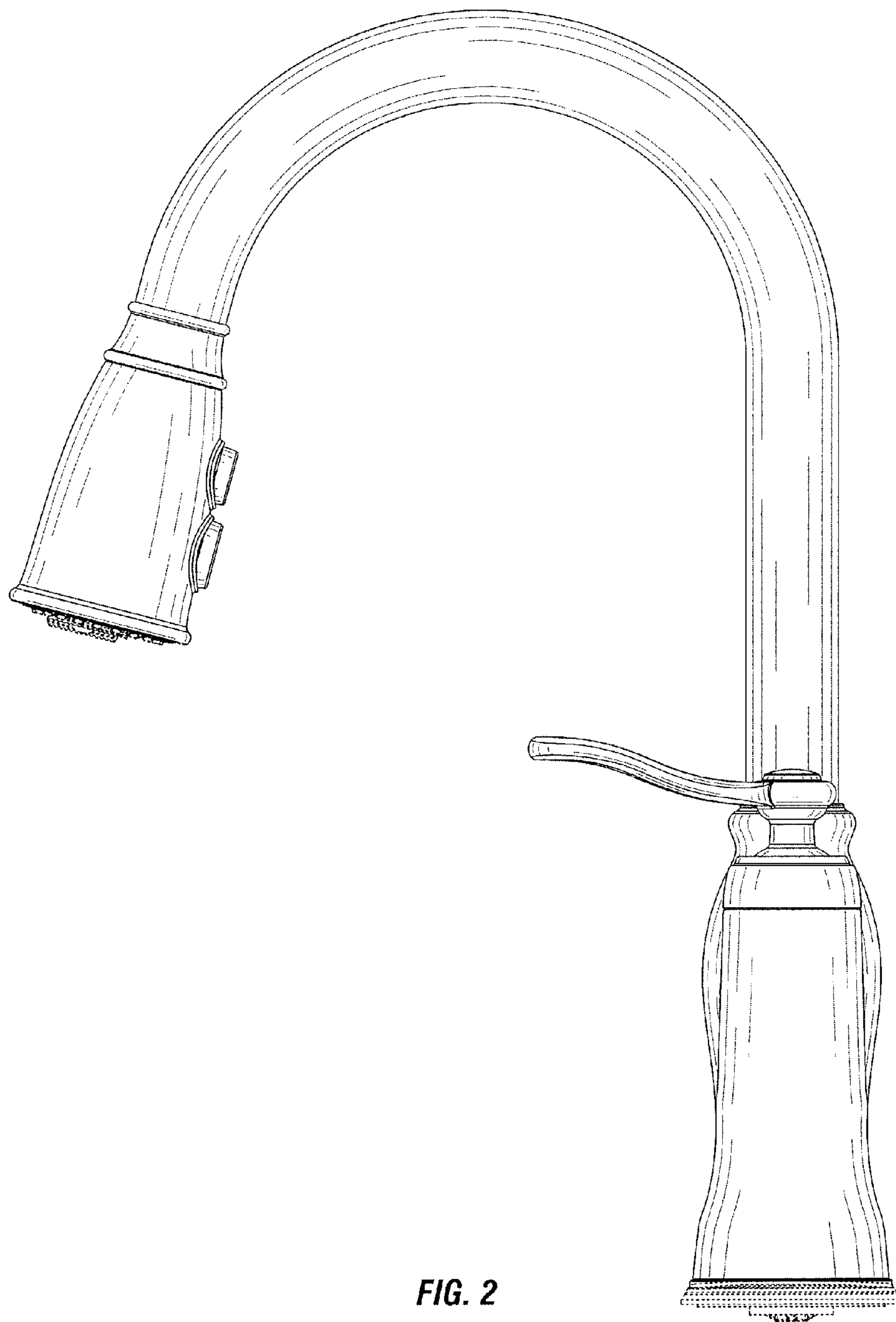

FIG. 2

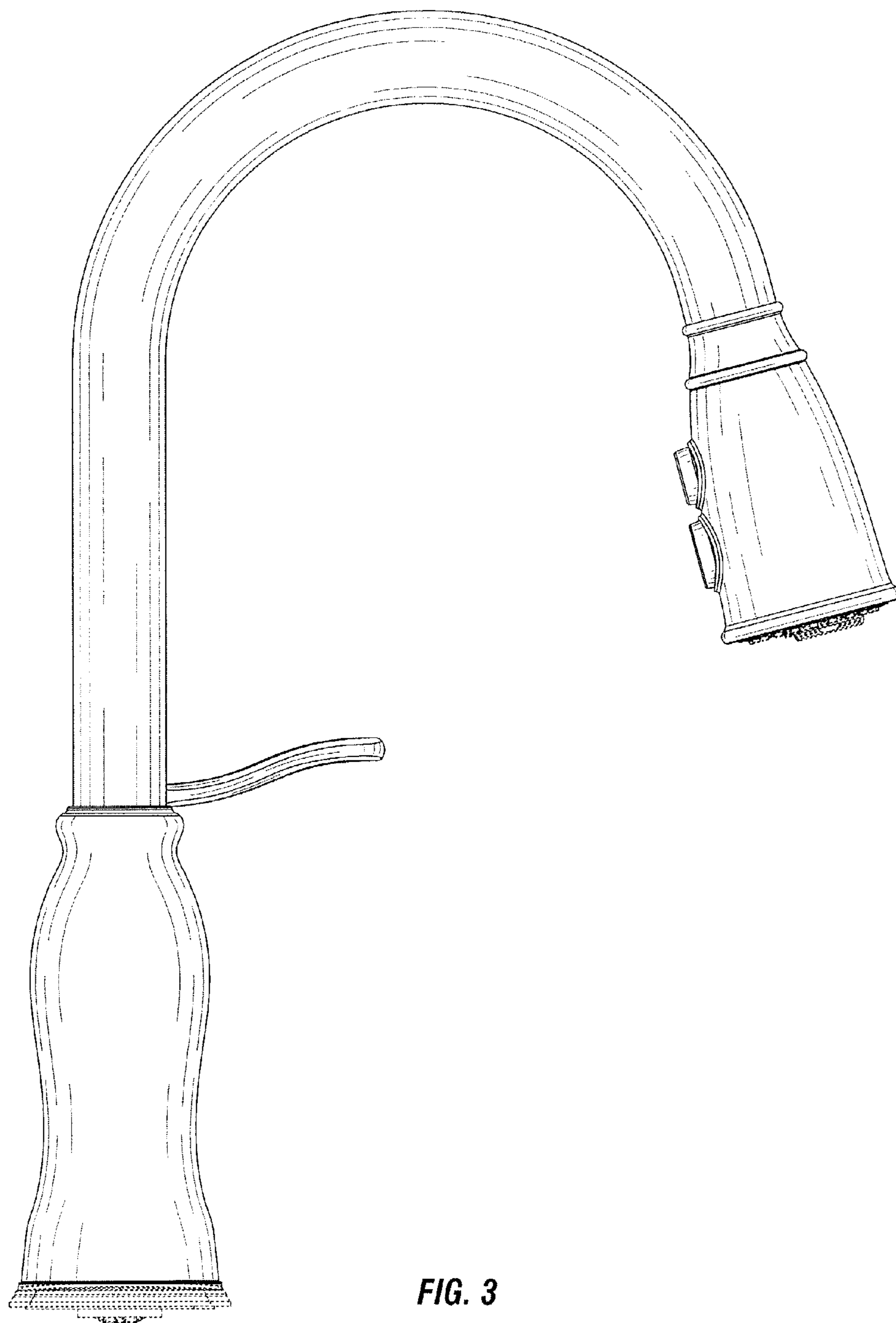

FIG. 3

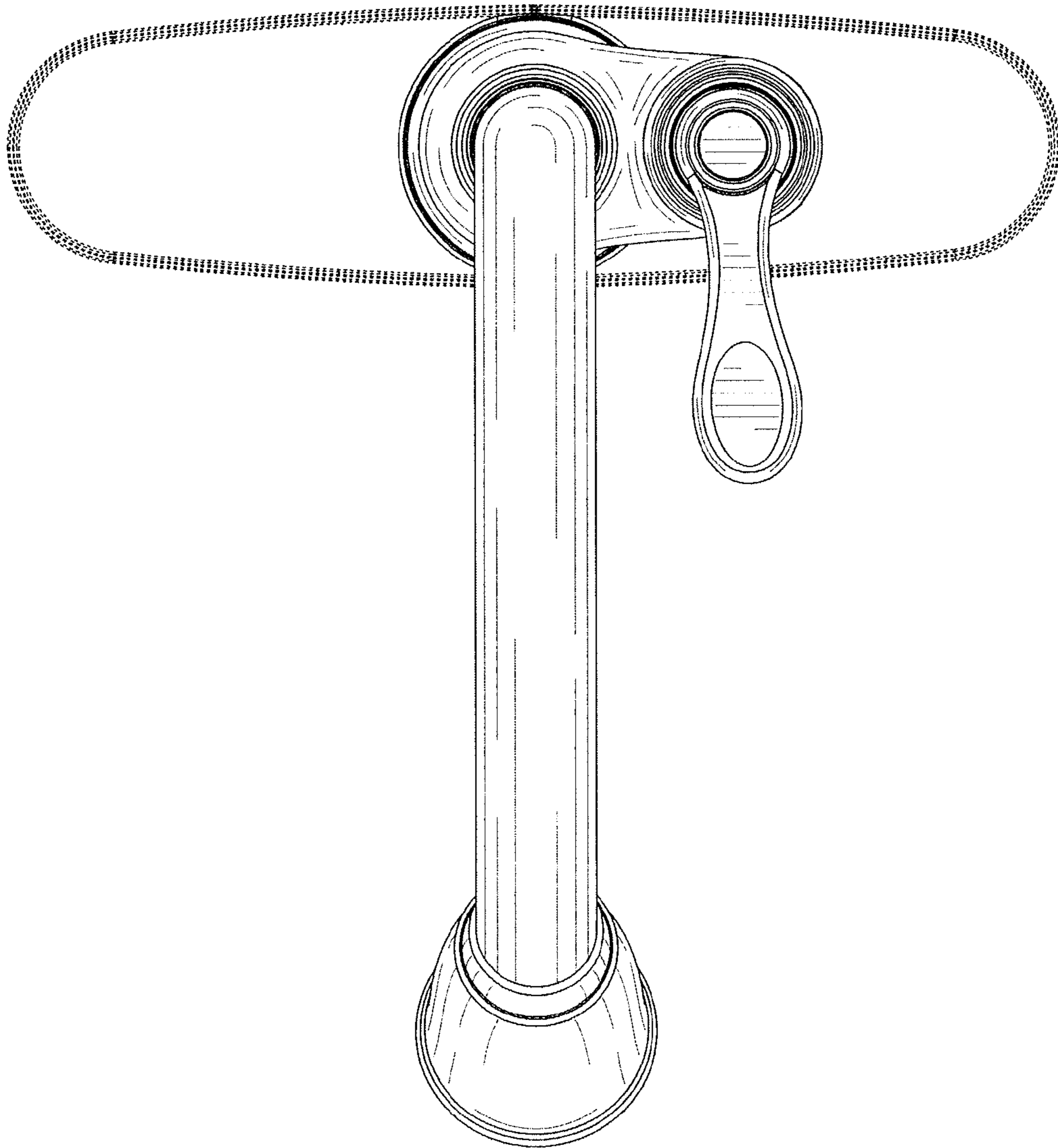

FIG. 4

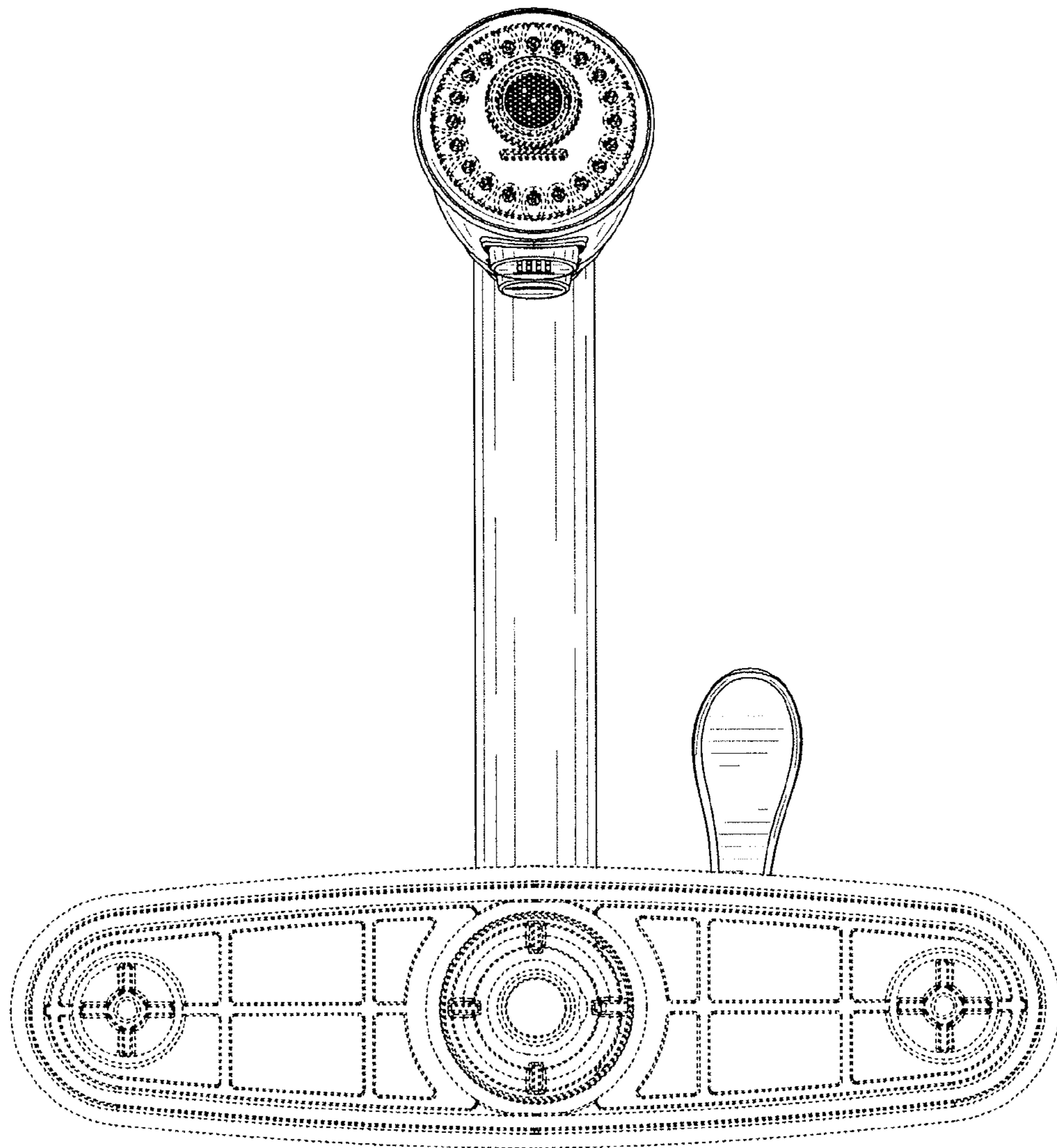

FIG. 5

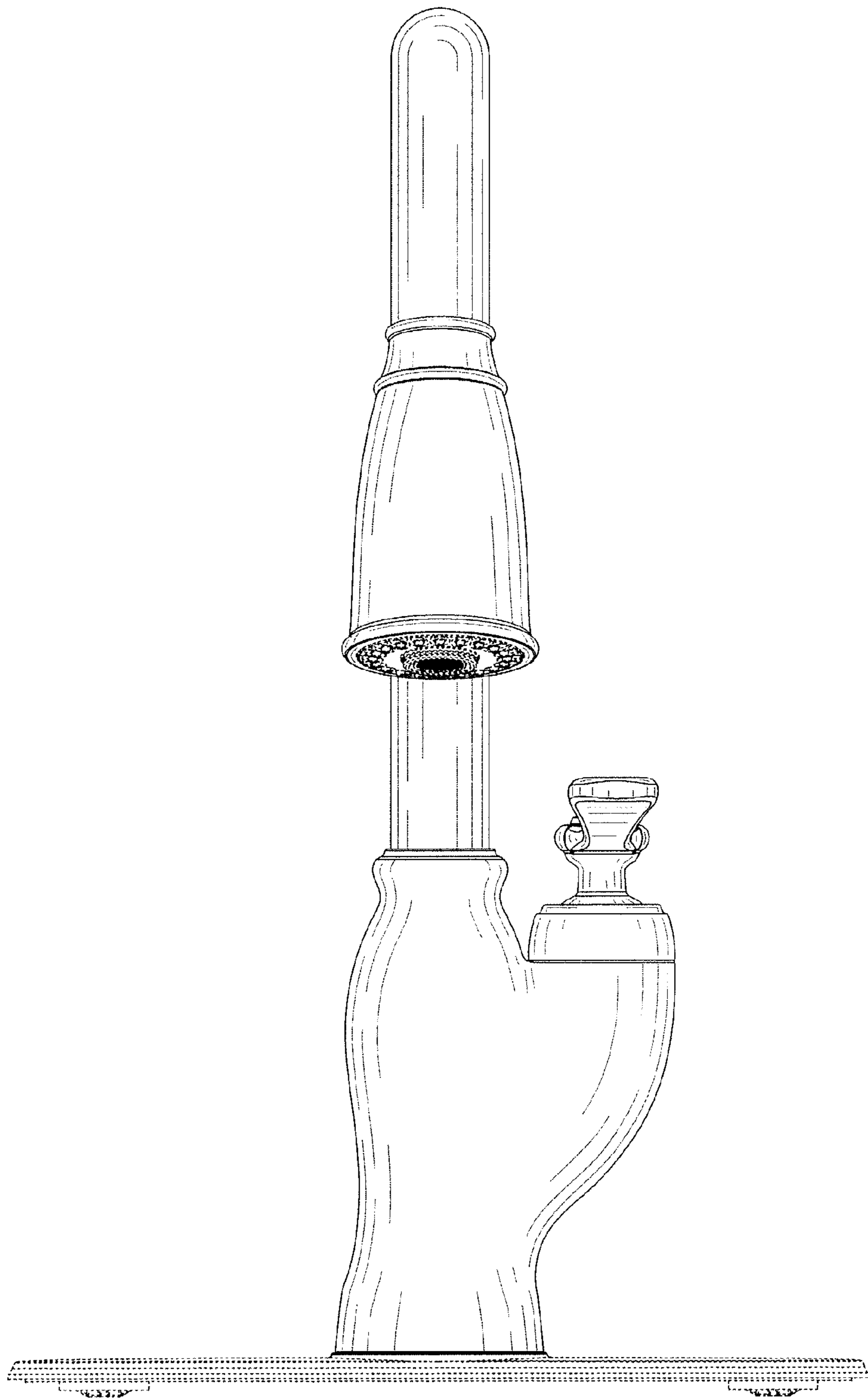

FIG. 6

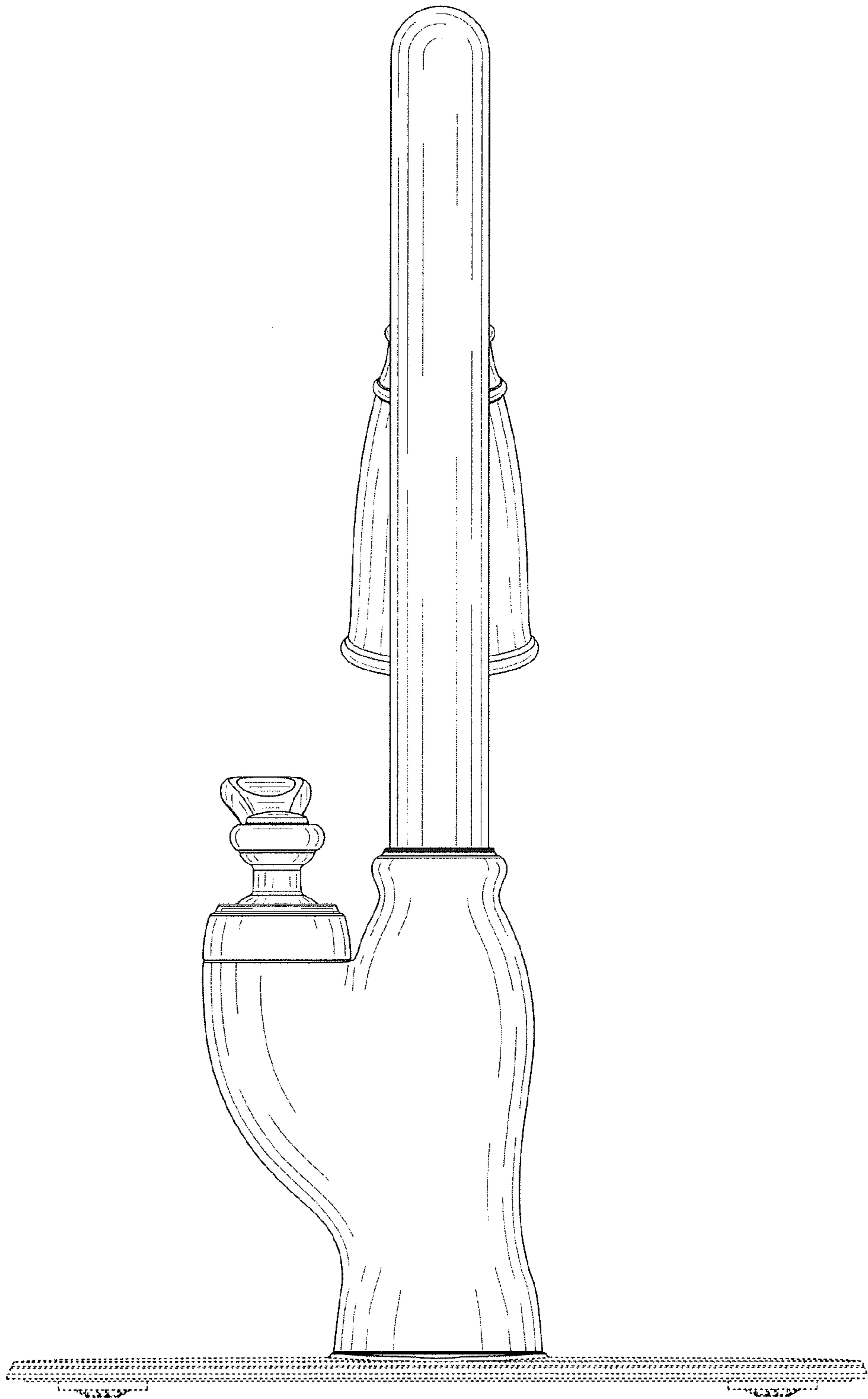

FIG. 7