



US00D713386S

(12) **United States Design Patent**  
**Yang**

(10) **Patent No.:** **US D713,386 S**

(45) **Date of Patent:** **\*\* Sep. 16, 2014**

(54) **EARPHONE**

(71) Applicant: **Bill Yang**, Taipei (TW)

(72) Inventor: **Bill Yang**, Taipei (TW)

(73) Assignee: **Cotron Corporation**, Taipei (TW)

(\*\*) Term: **14 Years**

(21) Appl. No.: **29/467,192**

(22) Filed: **Sep. 17, 2013**

(51) **LOC (10) Cl.** ..... **14-01**

(52) **U.S. Cl.**  
USPC ..... **D14/223**

(58) **Field of Classification Search**  
CPC ..... H04R 1/10  
USPC ..... D14/223, 205; 181/129, 130, 135;  
379/430, 431; 381/380, 381; 455/90.3,  
455/575.2  
See application file for complete search history.

(56) **References Cited**

**U.S. PATENT DOCUMENTS**

D554,627 S *	11/2007	Gondo	.....	D14/223
7,349,550 B2 *	3/2008	Oliveira et al.	.....	381/380
D567,217 S *	4/2008	Kamo et al.	.....	D14/205
D576,154 S *	9/2008	Ledbetter et al.	.....	D14/223
D587,681 S *	3/2009	Yanai	.....	D14/205
D587,685 S *	3/2009	Densho	.....	D14/206
D589,493 S *	3/2009	Densho	.....	D14/206
D594,441 S *	6/2009	Lee et al.	.....	D14/205

7,551,748 B2 *	6/2009	Kamo et al.	.....	381/380
D623,171 S *	9/2010	Chen et al.	.....	D14/223
D627,764 S *	11/2010	Tsai et al.	.....	D14/223
D628,564 S *	12/2010	Chong et al.	.....	D14/223
D637,181 S *	5/2011	Fuller et al.	.....	D14/223
D643,416 S *	8/2011	Chong et al.	.....	D14/223
D676,427 S *	2/2013	Yang	.....	D14/223
D698,761 S *	2/2014	Bao	.....	D14/223
D703,192 S *	4/2014	Yang	.....	D14/223

\* cited by examiner

*Primary Examiner* — Paula Greene

(74) *Attorney, Agent, or Firm* — Jianq Chyun IP Office

(57) **CLAIM**

The ornamental design for an earphone, as shown and described.

**DESCRIPTION**

FIG. 1 is a perspective view of an earphone showing my new design;  
FIG. 2 is another perspective view thereof;  
FIG. 3 is a front view thereof;  
FIG. 4 is a rear view thereof;  
FIG. 5 is a left side view thereof;  
FIG. 6 is a right side view thereof;  
FIG. 7 is a top view thereof; and,  
FIG. 8 is a bottom view thereof.

The broken line portions of the earphone in FIGS. 1-8 represent unclaimed portions of the claimed design and form no part thereof.

**1 Claim, 8 Drawing Sheets**

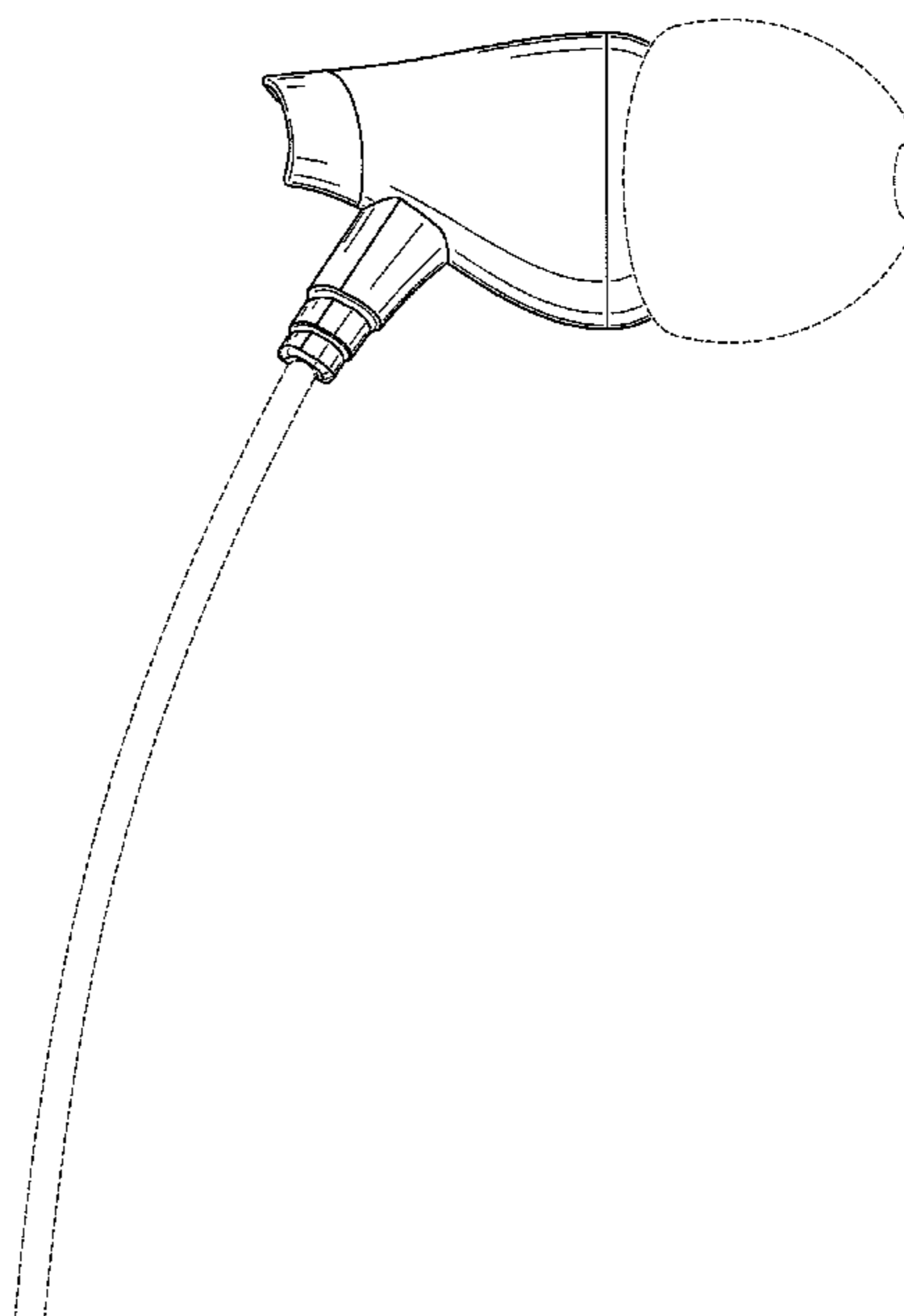
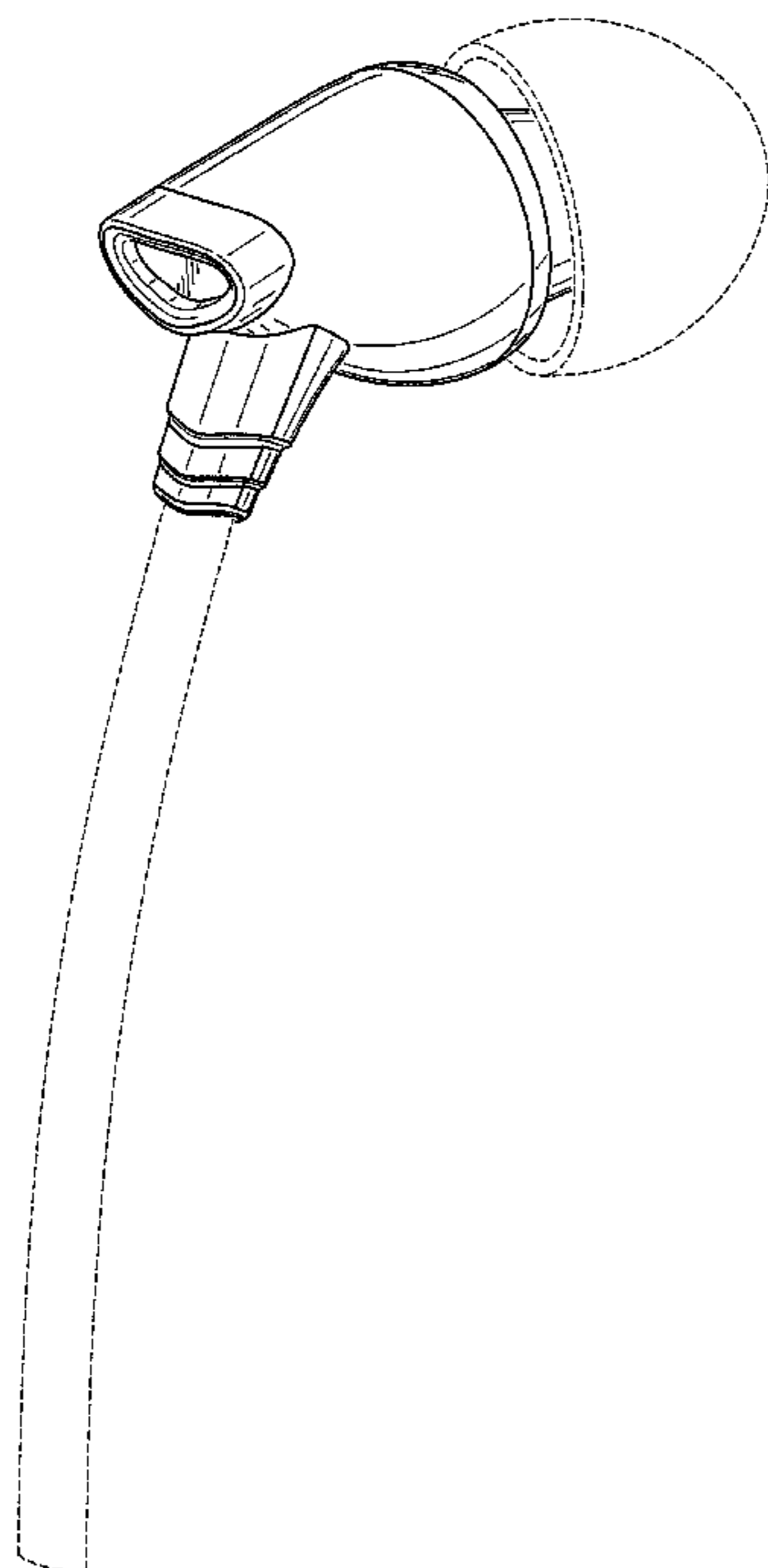

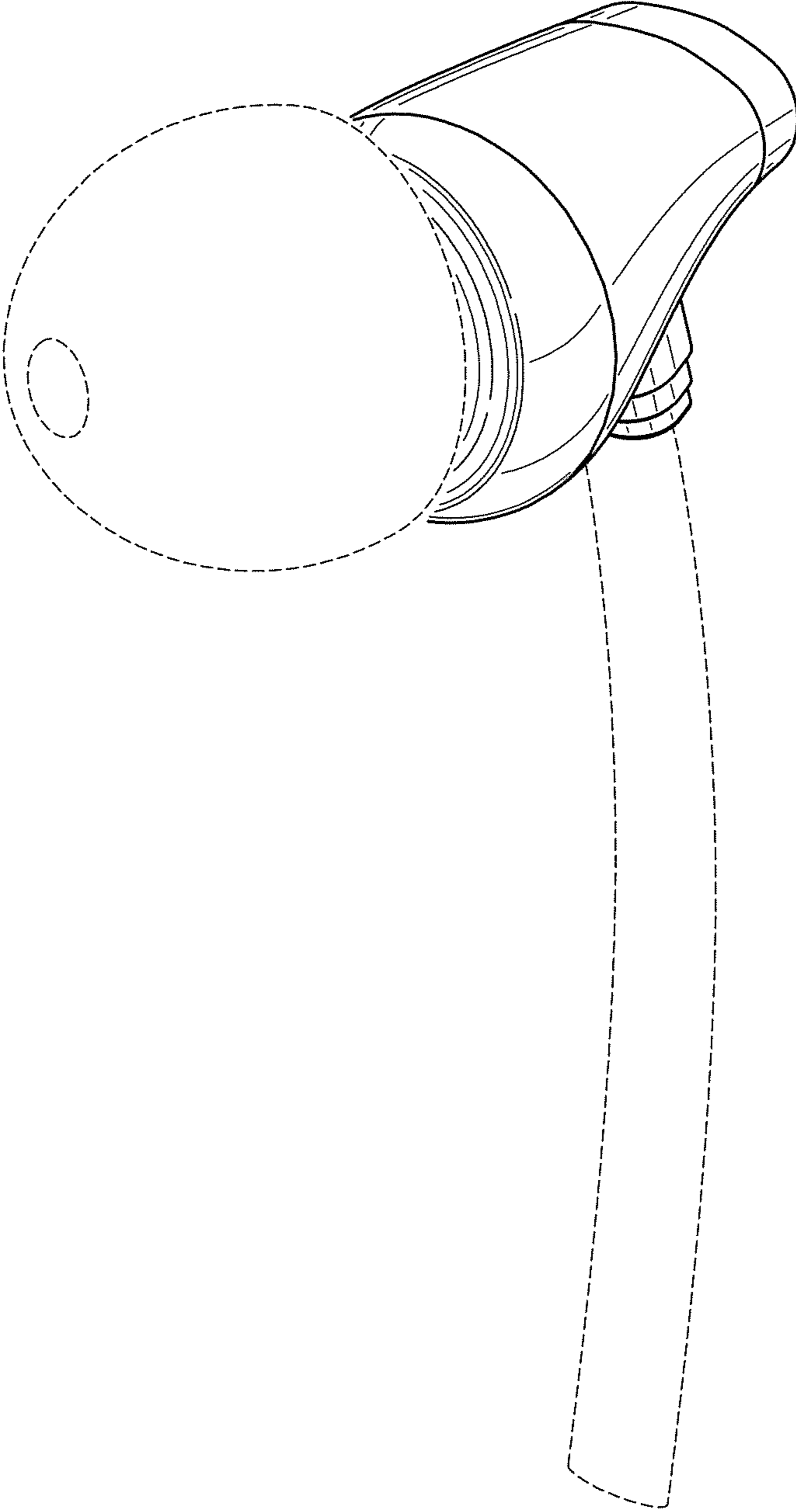

FIG. 1

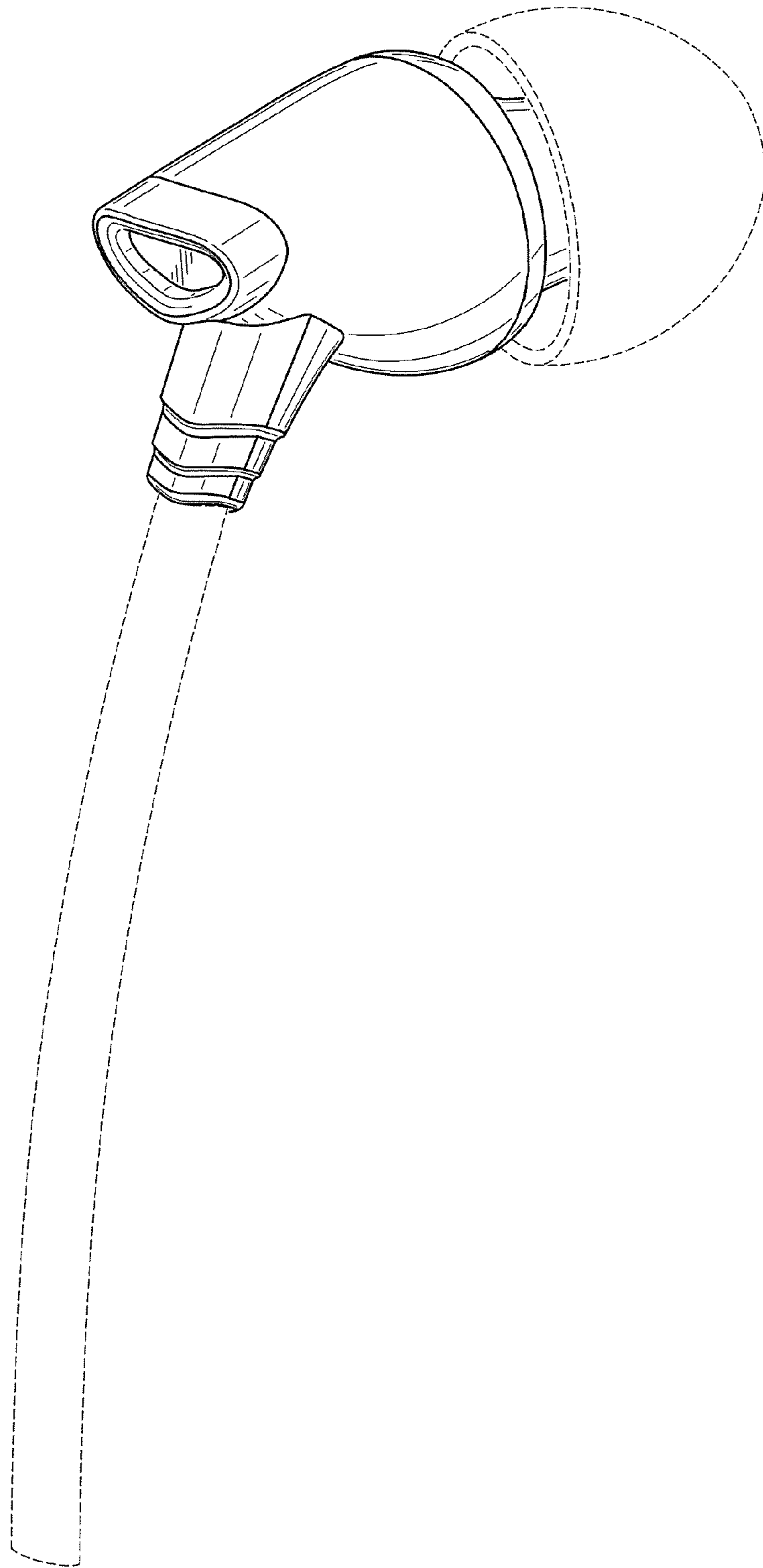

FIG. 2

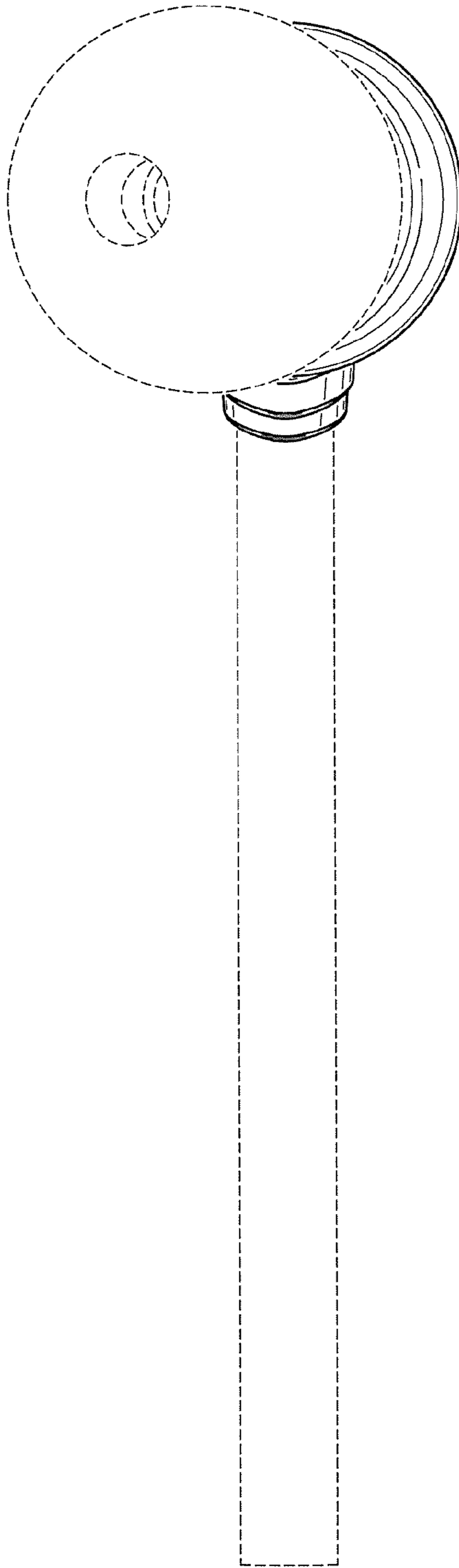

FIG. 3

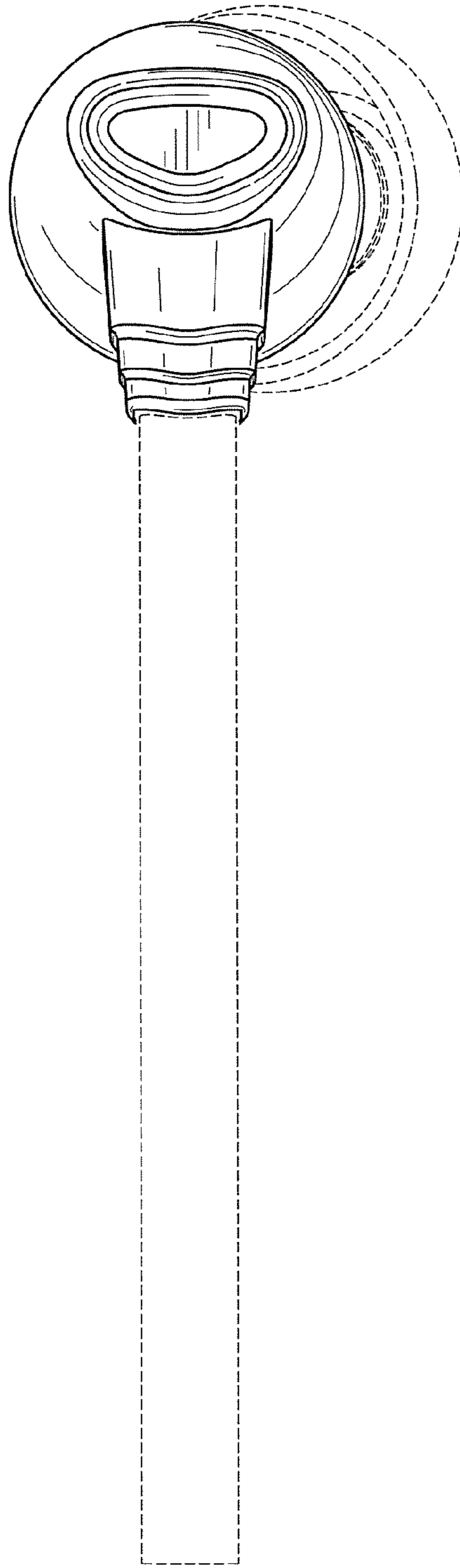

FIG. 4

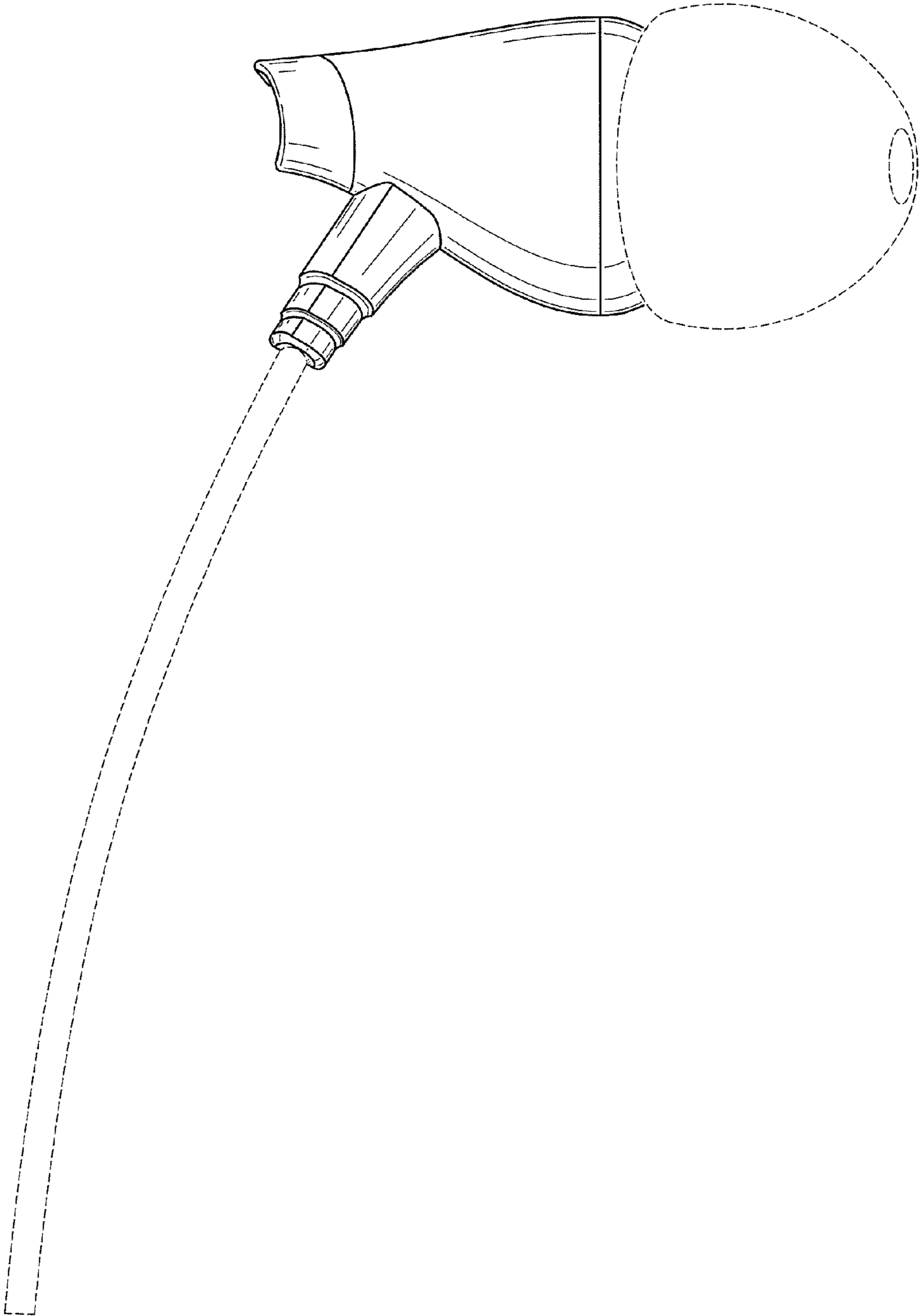

FIG. 5

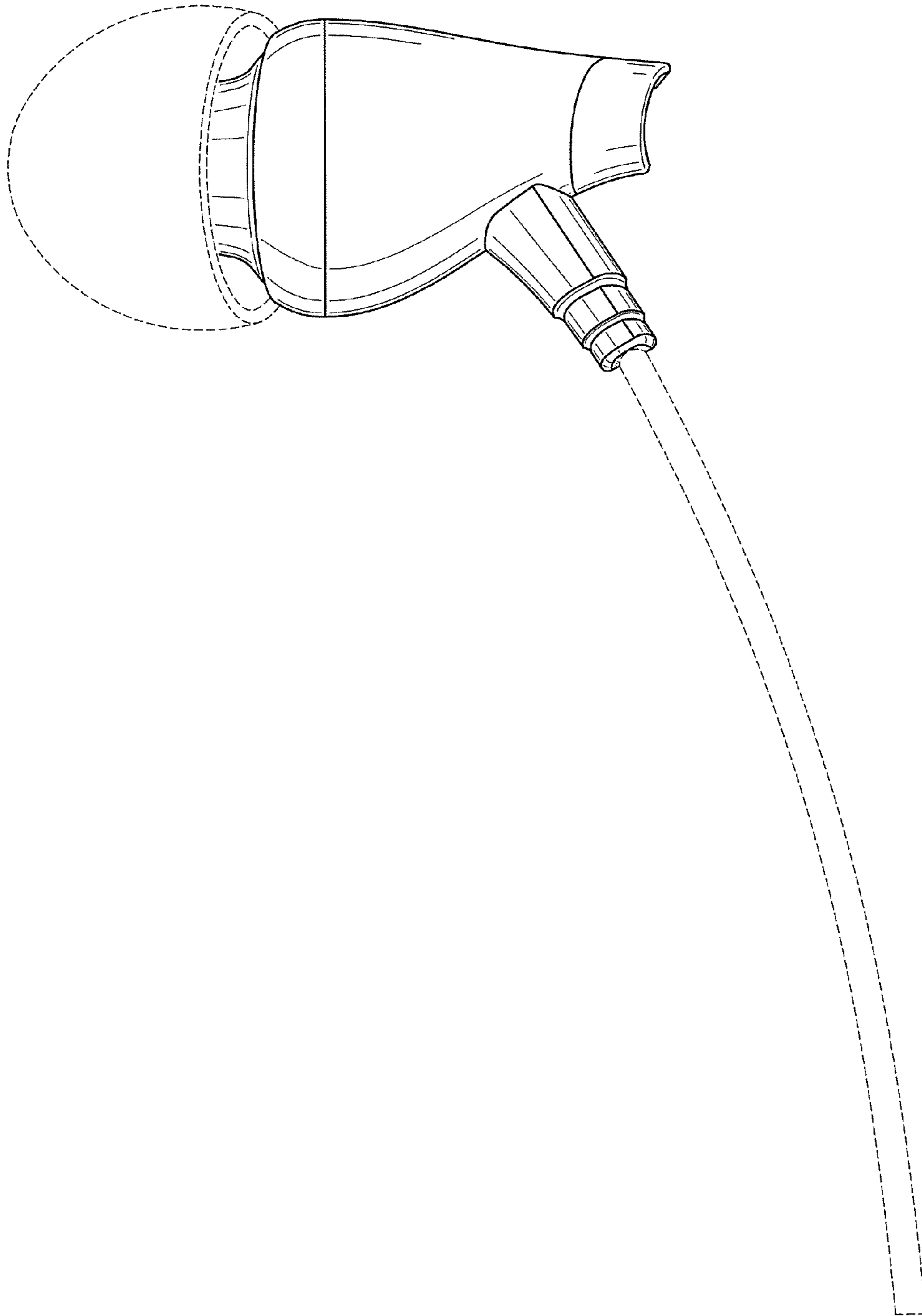

FIG. 6

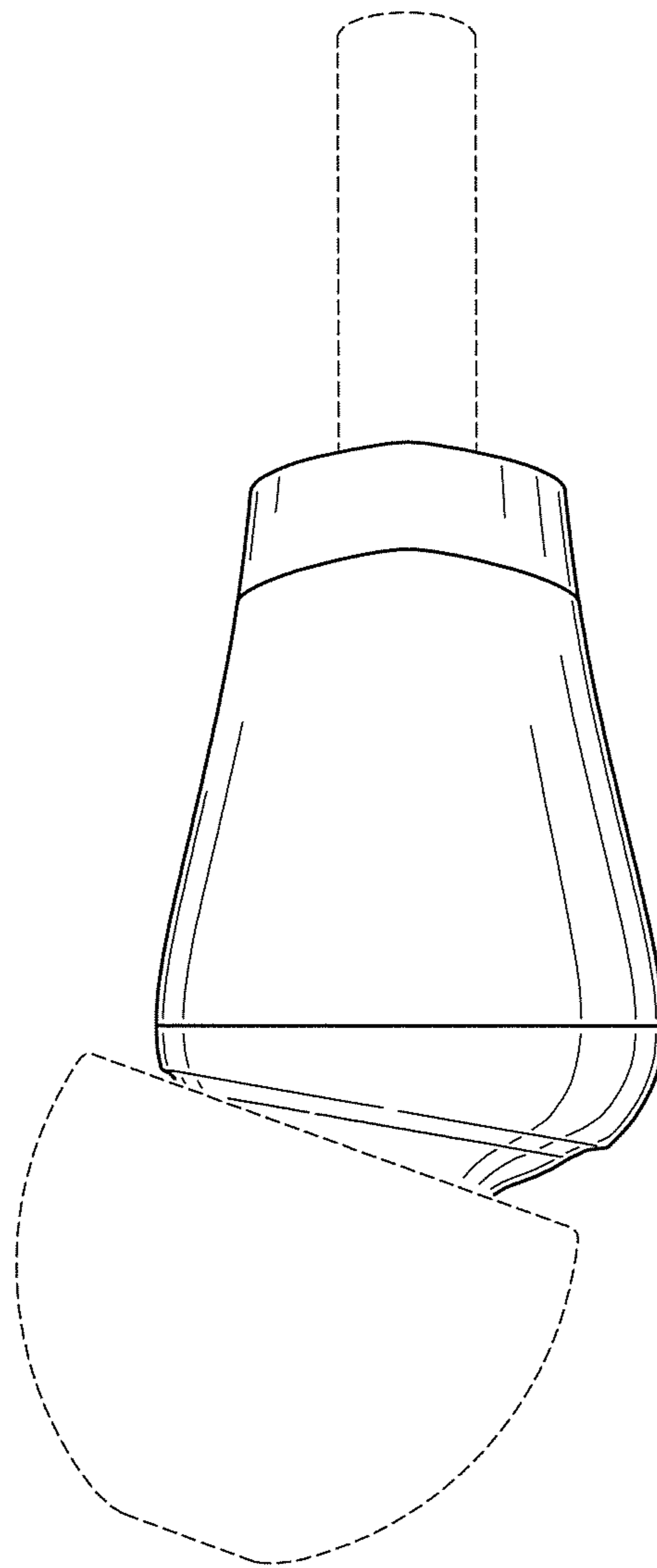

FIG. 7



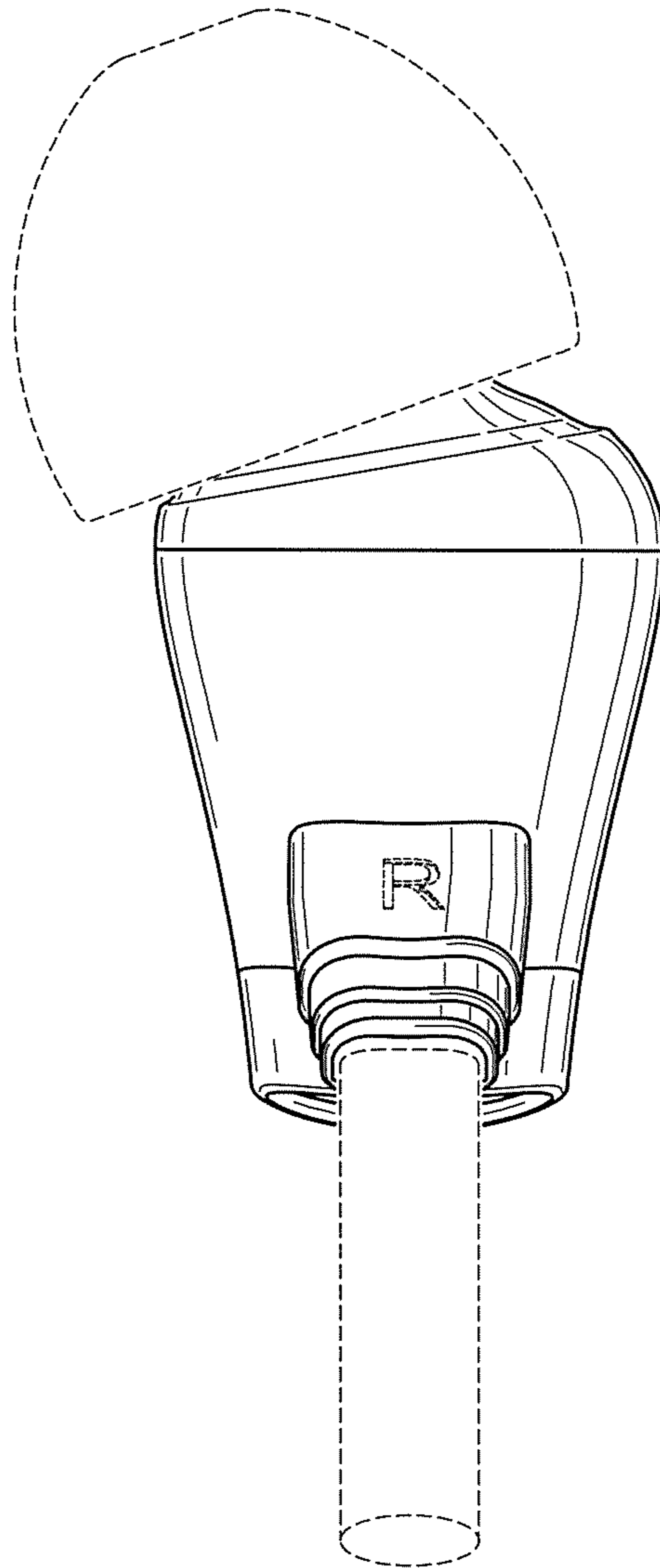

FIG. 8