



US00D713377S

(12) **United States Design Patent**  
**Kain**

(10) **Patent No.:** **US D713,377 S**

(45) **Date of Patent:** **\*\* Sep. 16, 2014**

(54) **HOME STEREO SPEAKER SYSTEM**

(71) Applicant: **Devin Michael Kain**, Brooklyn, NY (US)

(72) Inventor: **Devin Michael Kain**, Brooklyn, NY (US)

(73) Assignee: **Devin Kain**, Brooklyn, NY (US)

(\*\*) Term: **14 Years**

(21) Appl. No.: **29/463,157**

(22) Filed: **Aug. 16, 2013**

(51) **LOC (10) Cl.** ..... **14-01**

(52) **U.S. Cl.**  
USPC ..... **D14/207**

(58) **Field of Classification Search**  
CPC ..... H04R 1/02; H04R 1/025; H04R 1/026;  
H04R 3/00; H04R 5/00; H04R 5/02; H04R  
5/023; H04R 9/06; H04R 9/063; H04R 11/02;  
H04R 27/00; H04S 5/00; H04S 7/00  
USPC ..... D14/204, 207, 209.1, 210–217, 168,  
D14/172, 485; 181/143, 144, 147, 148,  
181/150–153, 157, 198, 199; 381/300–303,  
381/306, 332, 333, 336, 346, 361–364,  
381/386–388; D3/201, 218; D6/401, 632;  
345/158; 361/379.04, 679.01;  
273/148 B

See application file for complete search history.

(56) **References Cited**

**U.S. PATENT DOCUMENTS**

4,450,495 A \* 5/1984 Naruki ..... 360/137  
5,675,426 A \* 10/1997 Meisner et al. .... 348/838

5,898,650 A \* 4/1999 Porsbo et al. .... 369/30.89  
6,057,659 A \* 5/2000 Akiyama et al. .... 381/98  
D477,829 S \* 7/2003 Hussaini et al. .... D14/496  
7,095,867 B2 \* 8/2006 Schul et al. .... 381/334  
D563,431 S \* 3/2008 Entner ..... D14/496  
D566,130 S \* 4/2008 Entner ..... D14/496  
D572,235 S \* 7/2008 Imawaki ..... D14/207  
D582,661 S \* 12/2008 Katsof ..... D3/201  
D597,525 S \* 8/2009 Jha ..... D14/207  
D609,696 S \* 2/2010 Martinez et al. .... D14/209.1

\* cited by examiner

*Primary Examiner* — Prabhakar Deshmukh

(57) **CLAIM**

The ornamental design for a home stereo speaker system, as shown and described.

**DESCRIPTION**

FIG. 1 is a top, front, and side perspective view of a home stereo speaker system showing my new design, shown in a closed position:

FIG. 2 is a top, front, and side perspective view thereof, shown in open position.

FIG. 3 is a right side elevational view thereof;

FIG. 4 is a left side elevational view thereof;

FIG. 5 is a rear elevational view of FIG. 1;

FIG. 6 is a rear elevational view of FIG. 2;

FIG. 7 is a front elevational view of FIG. 1;

FIG. 8 is a front elevational view of FIG. 2;

FIG. 9 is a top, rear, and side perspective view of FIG. 1;

FIG. 10 is a top, rear, and side perspective view of FIG. 2;

FIG. 11 is a top plan view of FIG. 1, the bottom plan view being a mirror image thereof; and,

FIG. 12 is a top plan view of FIG. 2, the bottom plan view being a mirror image thereof.

**1 Claim, 6 Drawing Sheets**

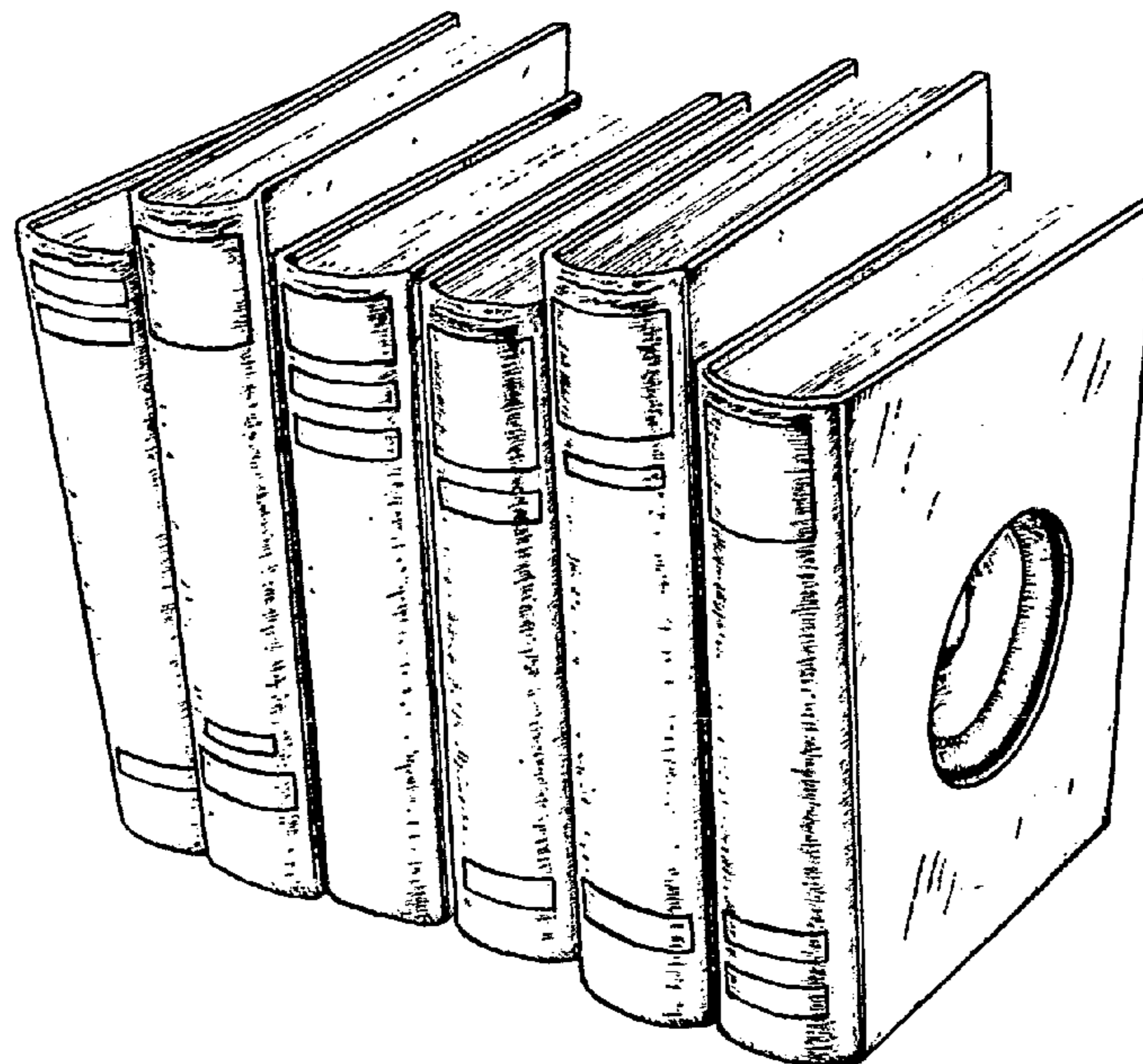

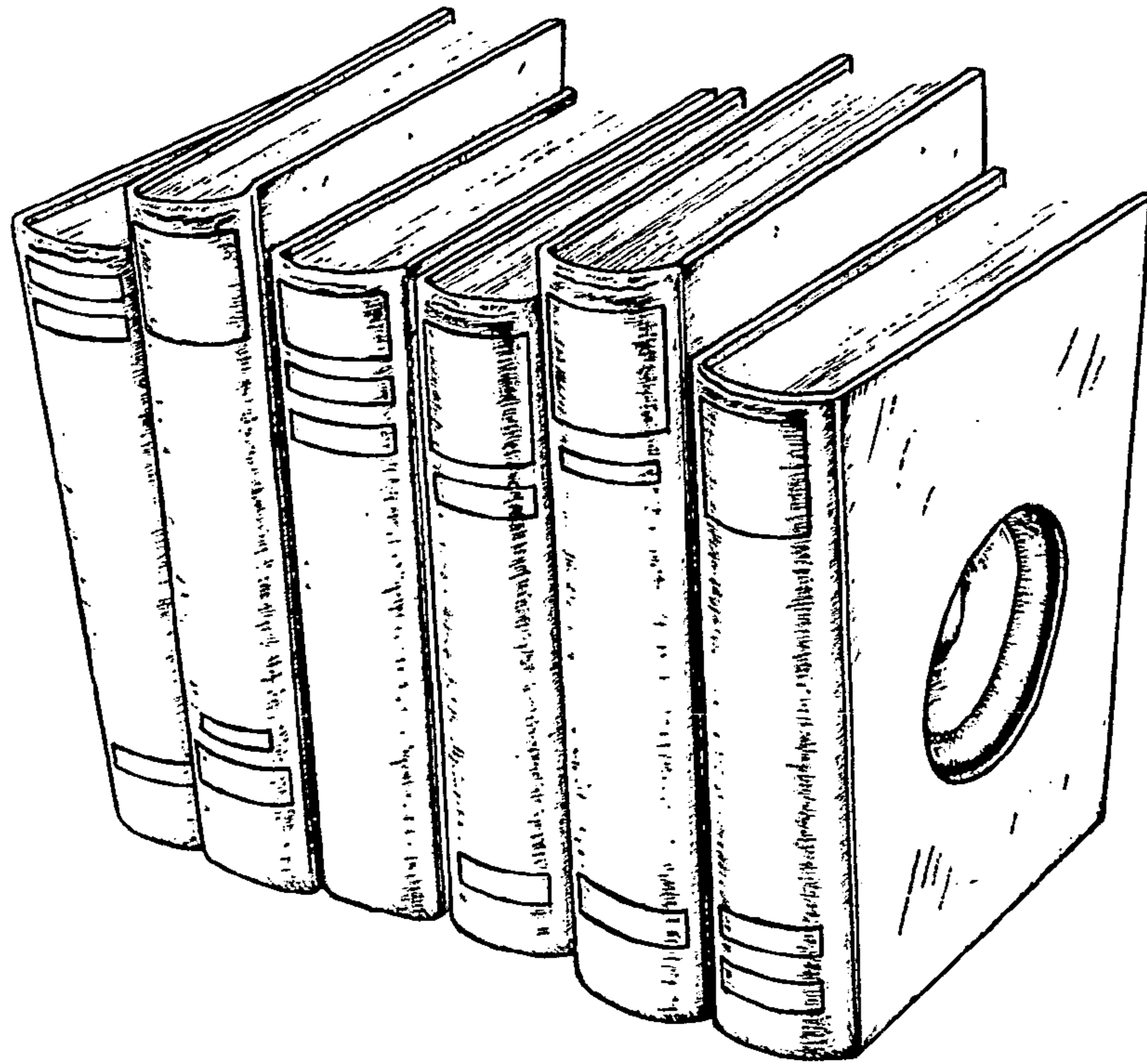

FIG. 1

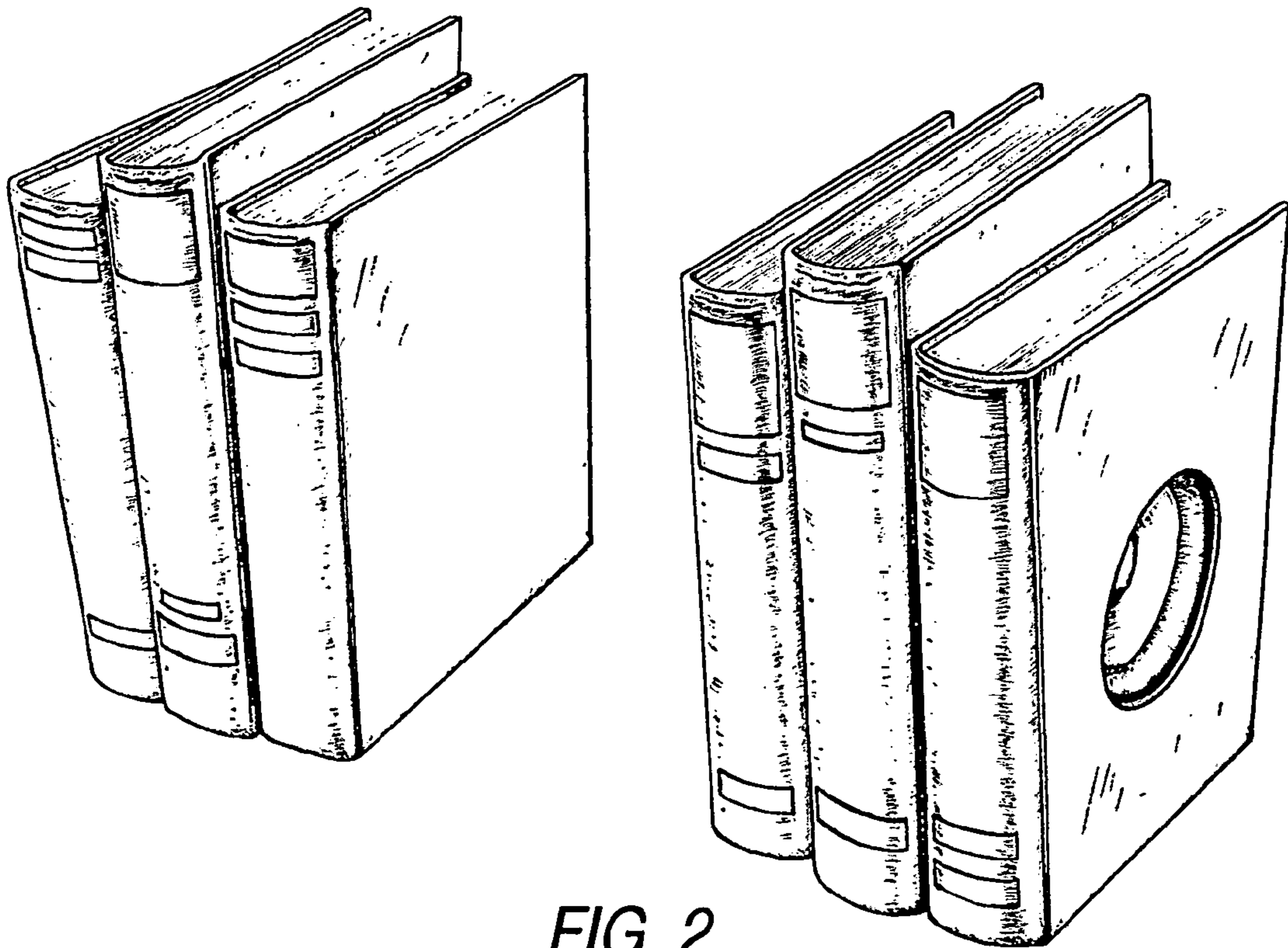

FIG. 2

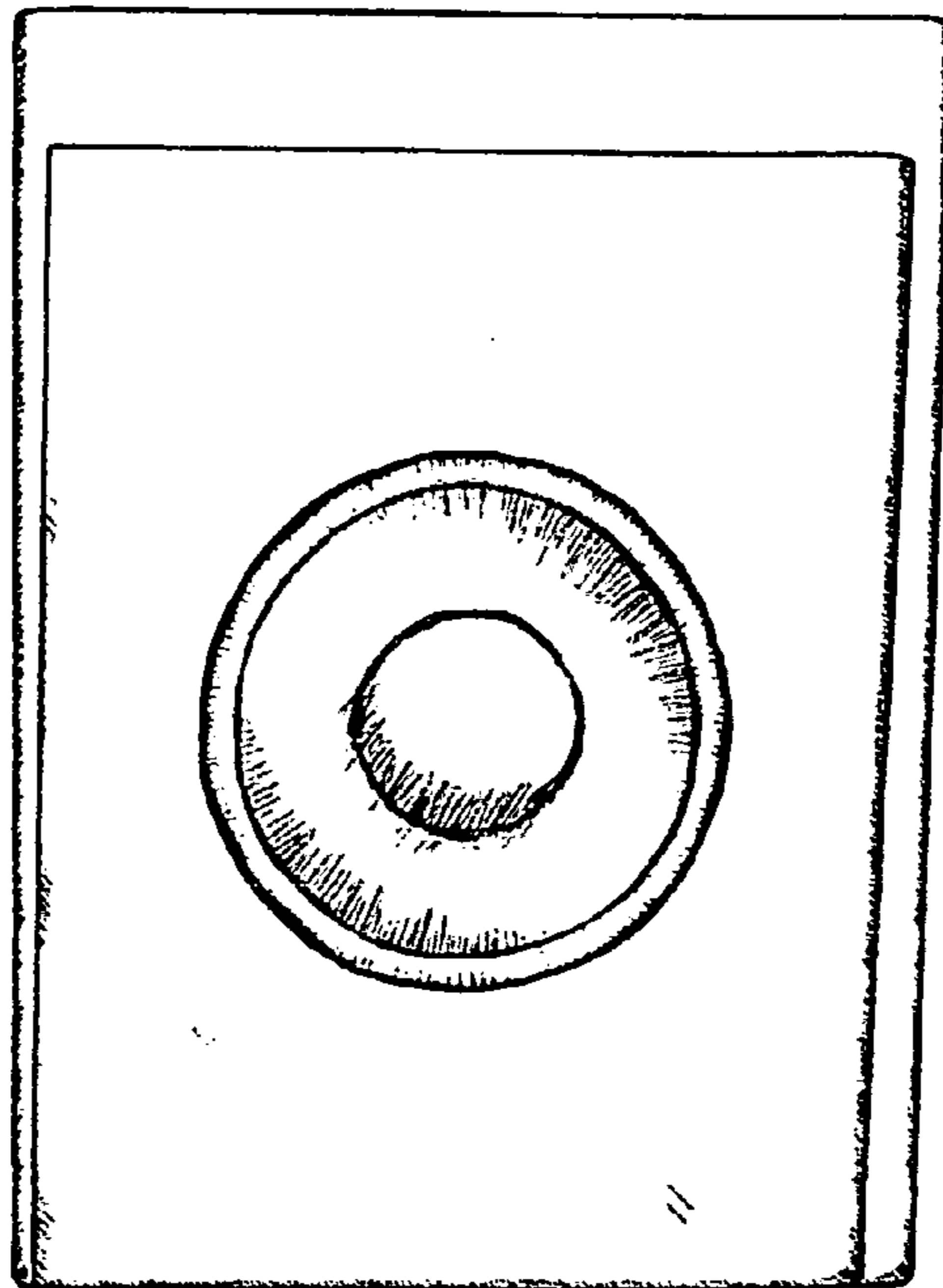

FIG. 3

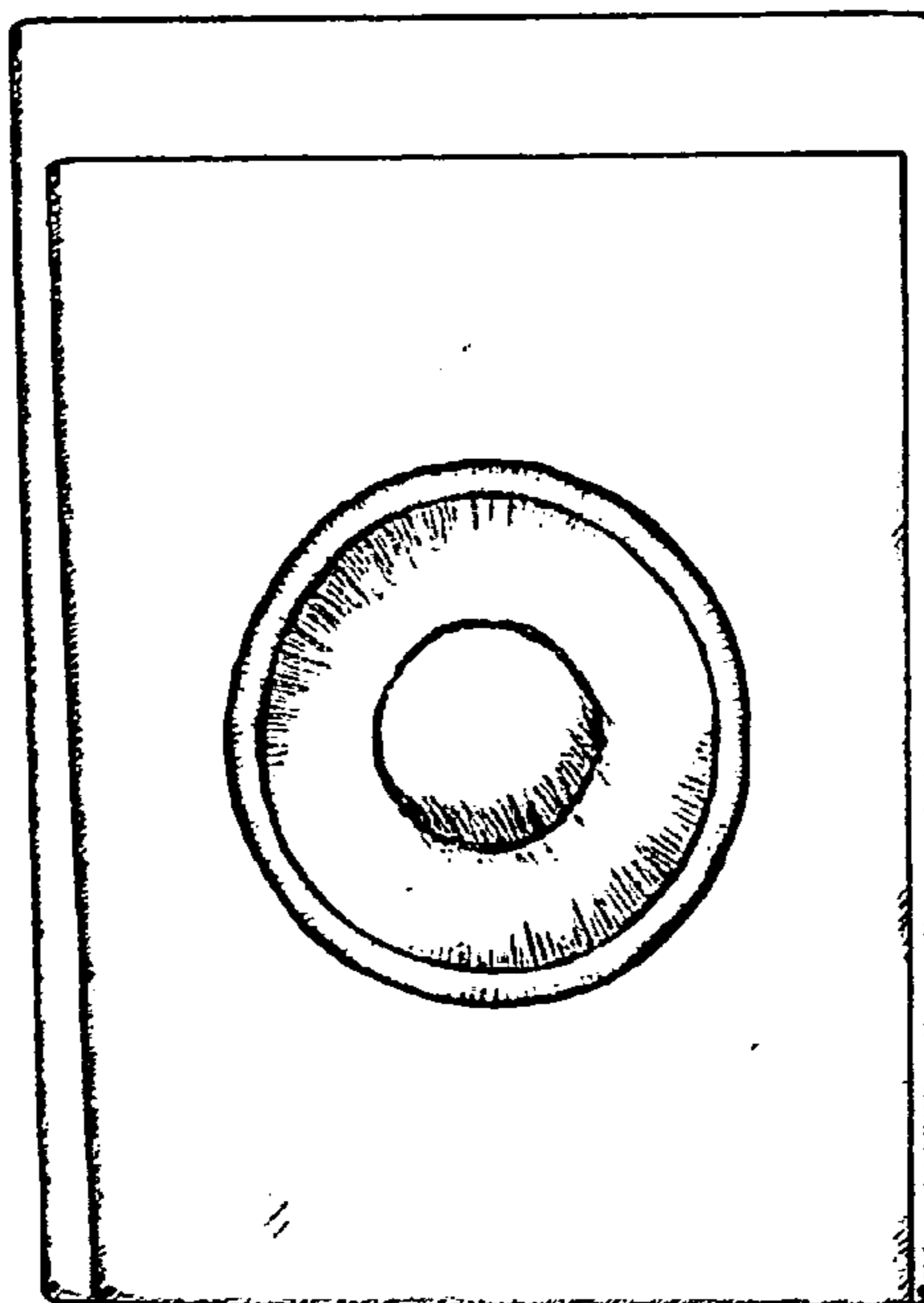

FIG. 4

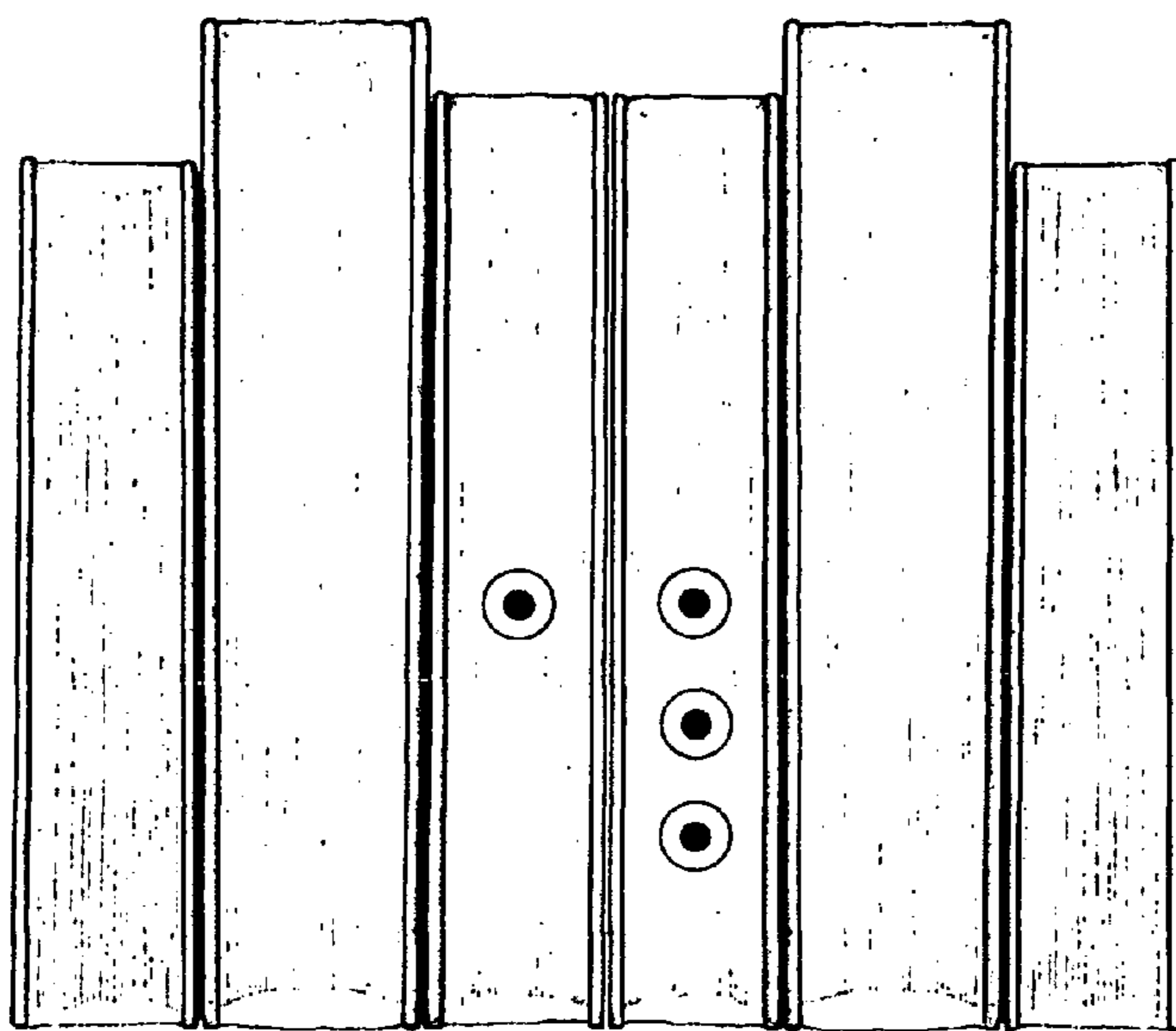

FIG. 5

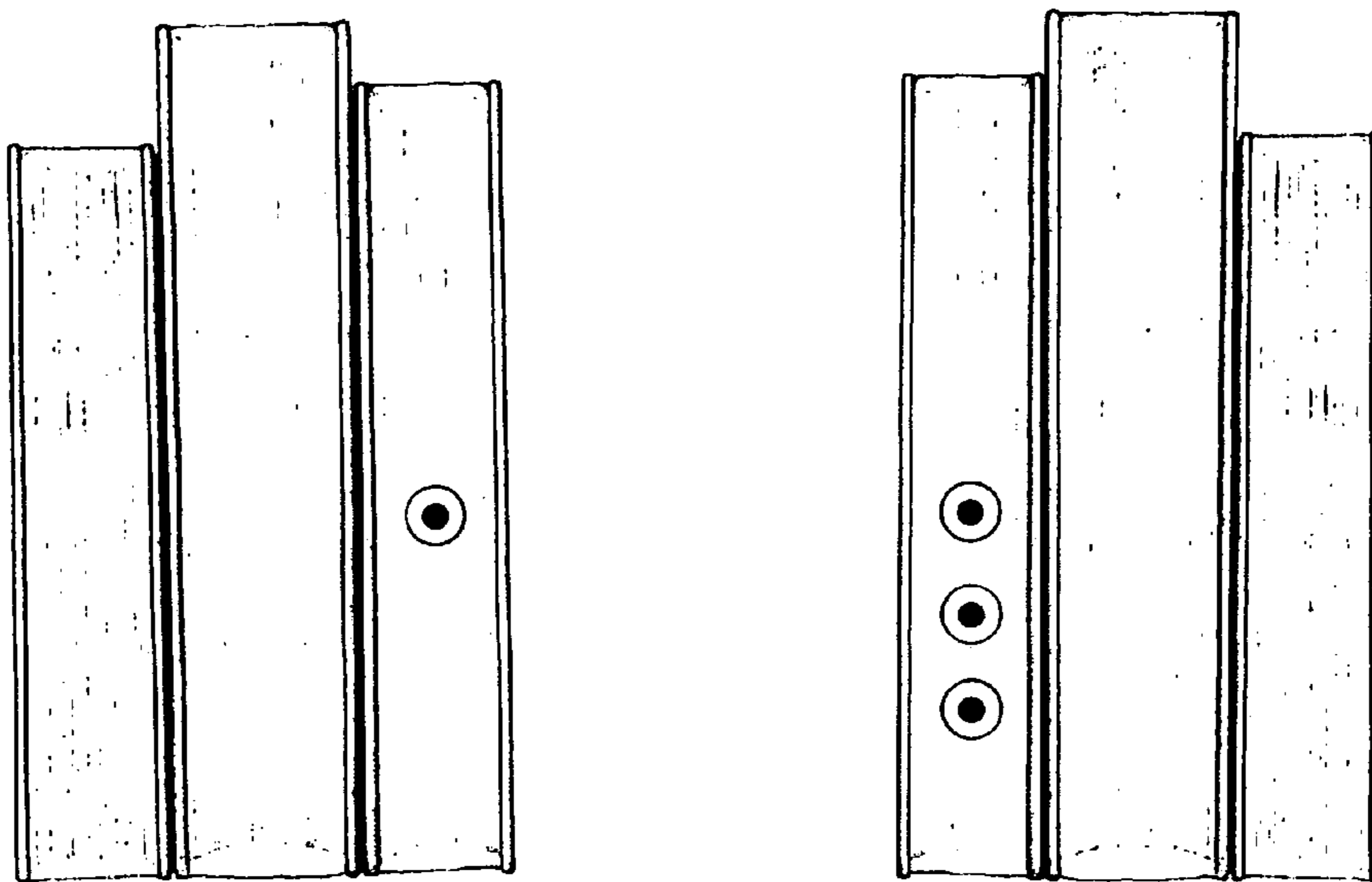

FIG. 6

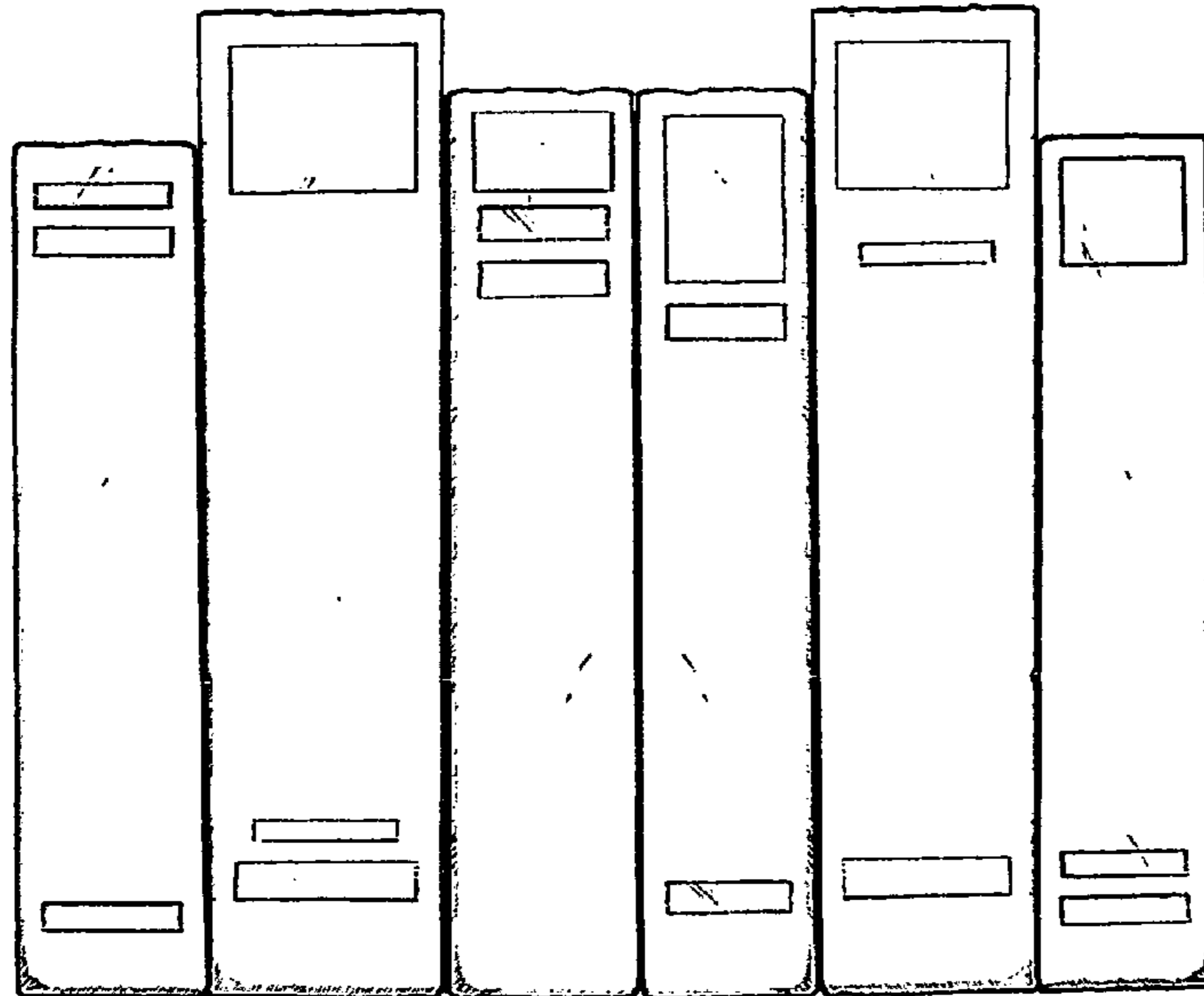

FIG. 7

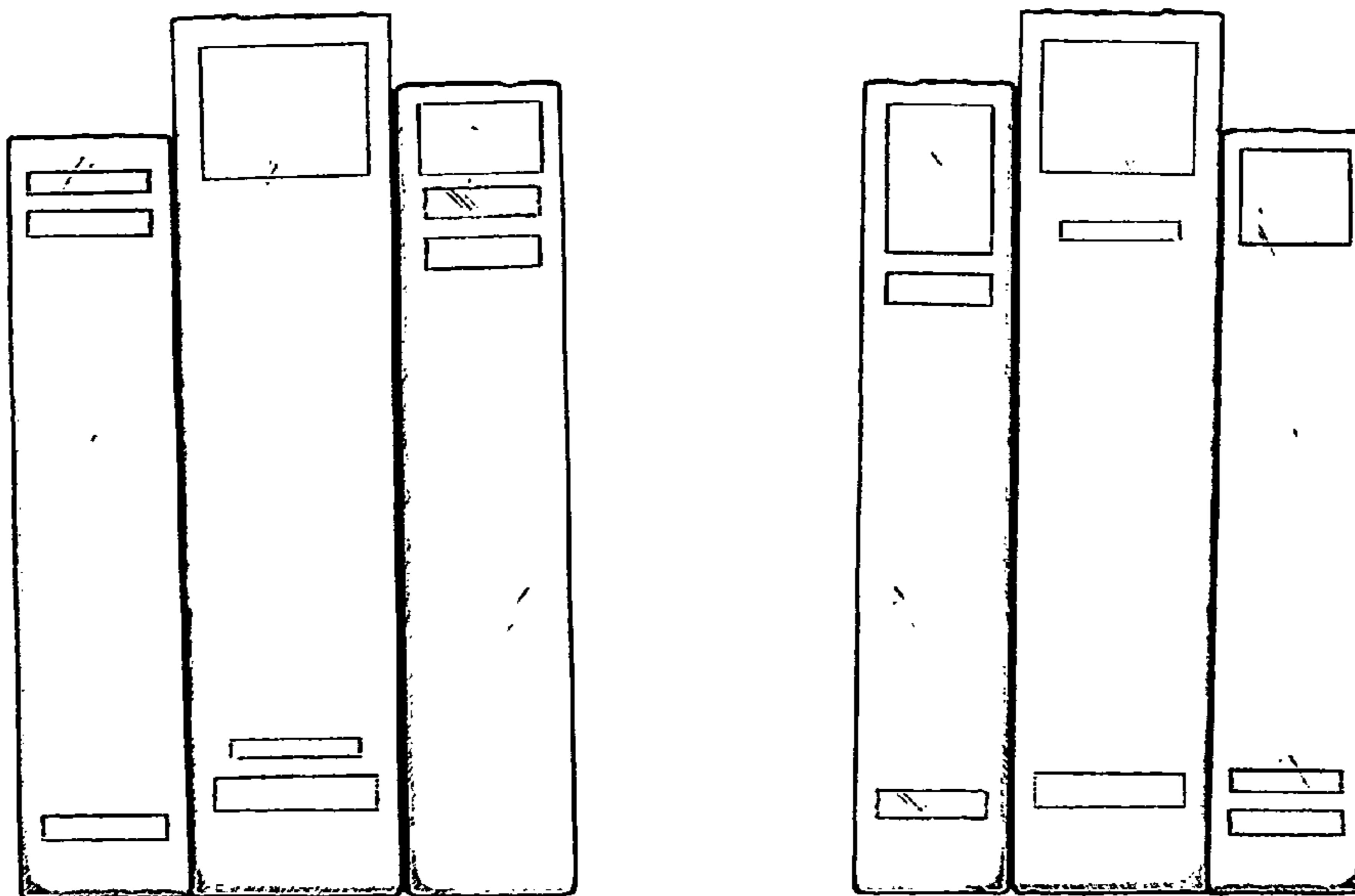

FIG. 8

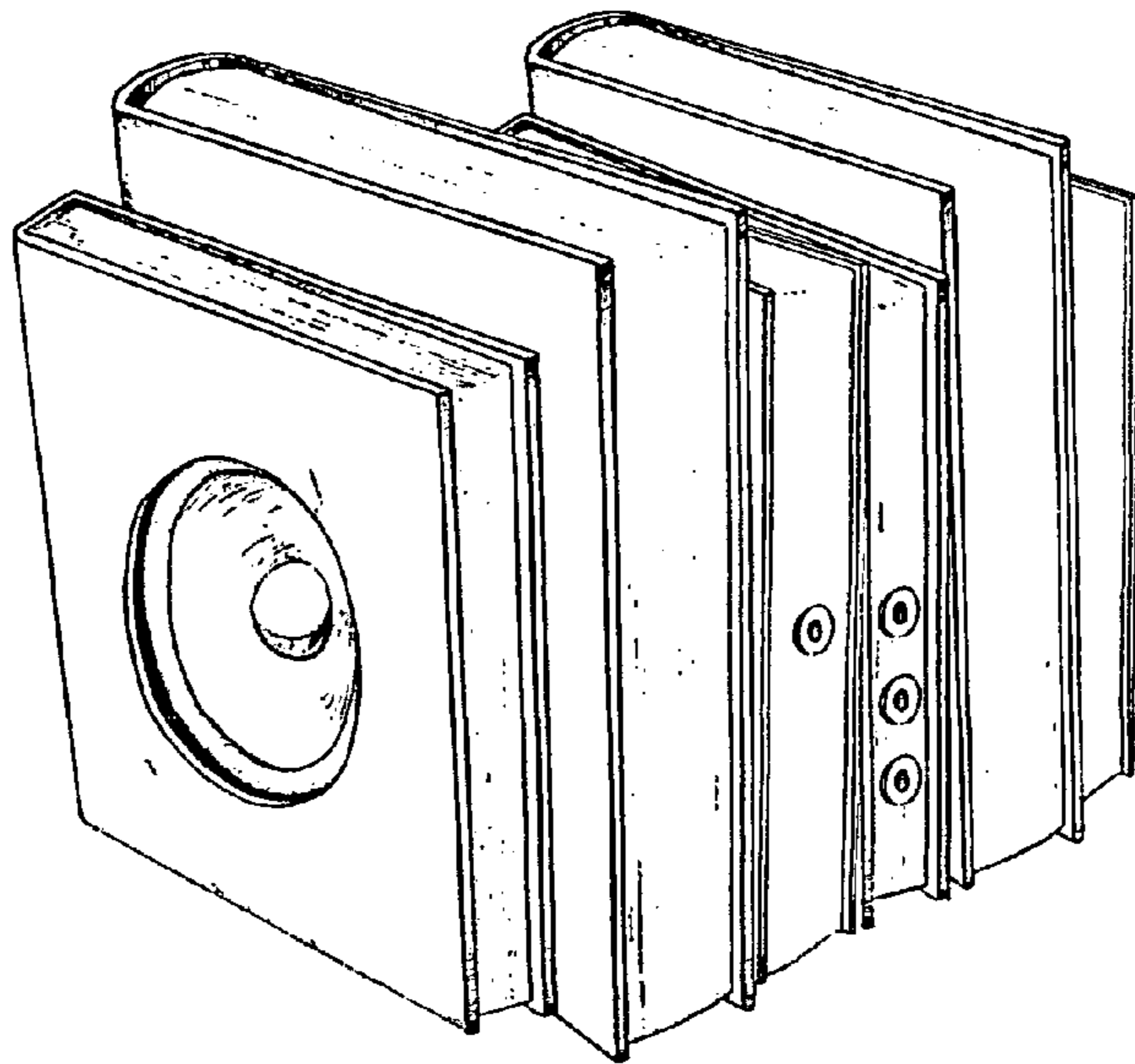

FIG. 9

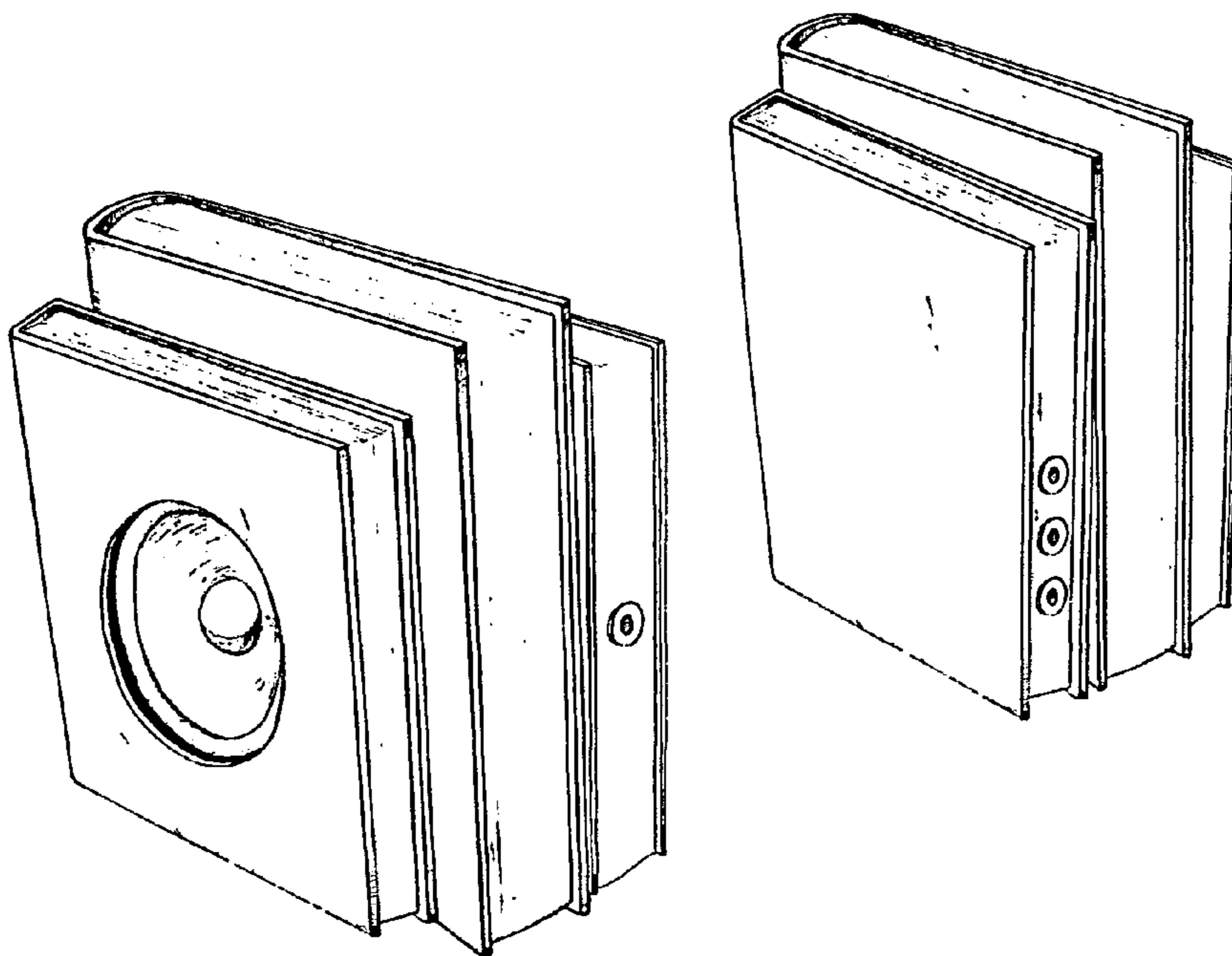

FIG. 10

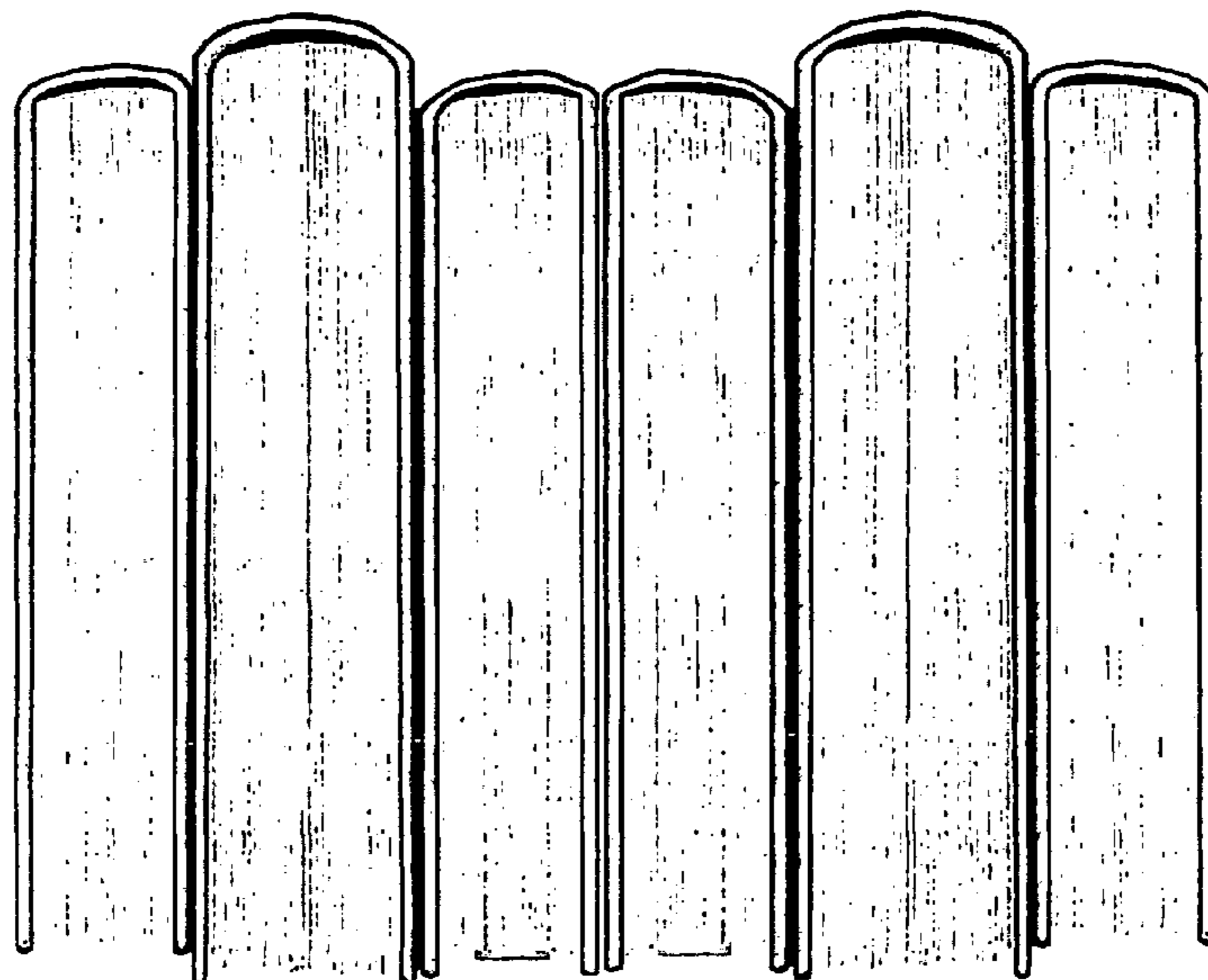

FIG. 11

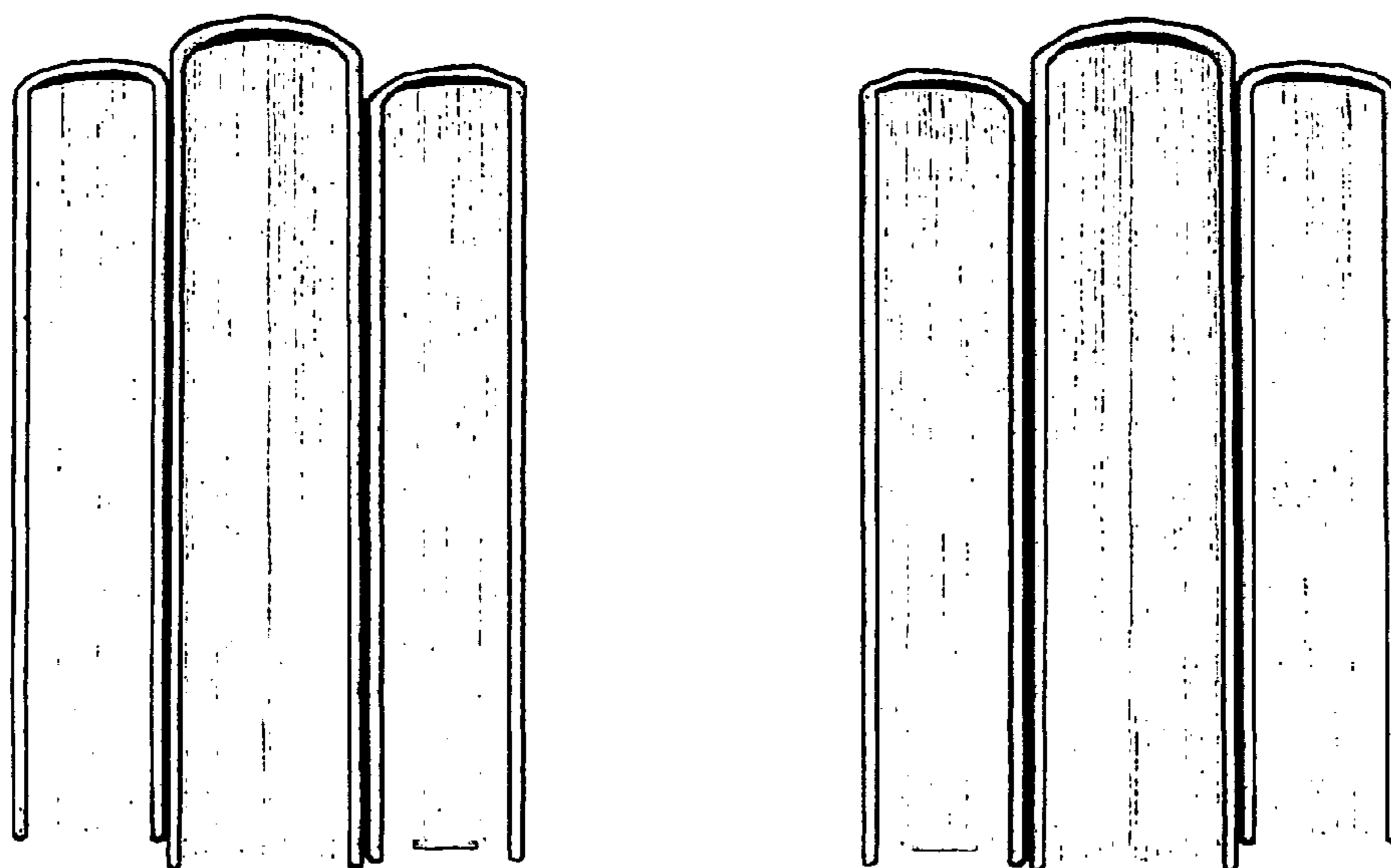

FIG. 12