



US00D713338S

(12) **United States Design Patent**  
**Lannoch et al.**

(10) **Patent No.:** **US D713,338 S**

(45) **Date of Patent:** **\*\* Sep. 16, 2014**

(54) **ELECTRIC MOTOR**

(71) Applicant: **Sew-Eurodrive GmbH & Co KG**,  
Bruchsal (DE)

(72) Inventors: **Hans-Jürgen Lannoch**,  
Linkenheim-Hochstetten (DE); **Marc Stammberger**,  
Knittlingen (DE); **Herr Franz Daminger**,  
Ludwigshafen am Rhein (DE)

(73) Assignee: **Sew-Europe GmbH & Co. KG**,  
Bruchsal (DE)

(\*\*) Term: **14 Years**

(21) Appl. No.: **29/465,654**

(22) Filed: **Aug. 30, 2013**

(30) **Foreign Application Priority Data**

Mar. 2, 2013 (DE) ..... 40 2013 001 097

(51) **LOC (10) Cl.** ..... **13-01**

(52) **U.S. Cl.**  
USPC ..... **D13/112**

(58) **Field of Classification Search**  
USPC ..... D13/112, 113, 114, 122, 199; D15/3, 5,  
D15/199; 74/606 R, 609; 310/10, 40 R, 42,  
310/51, 58, 71, 85, 89, 91, 109, 236, 239,  
310/254; 318/245, 255

See application file for complete search history.

(56) **References Cited**

U.S. PATENT DOCUMENTS

D236,985 S *	9/1975	Baumann .....	D13/114
D336,890 S *	6/1993	Hirose et al. ....	D13/112
D424,516 S *	5/2000	Friedrichsen .....	D13/112
D595,648 S *	7/2009	Lannoch .....	D13/112
D609,181 S *	2/2010	Lannoch .....	D13/112
D667,372 S *	9/2012	Lannoch .....	D13/112

\* cited by examiner

*Primary Examiner* — Derrick Holland

(74) *Attorney, Agent, or Firm* — Finnegan, Henderson,  
Farabow, Garrett & Dunner, L.L.P.

(57) **CLAIM**

The ornamental design for an electric motor, as shown and described.

**DESCRIPTION**

FIG. 1 is a front right perspective view of an electric motor showing our new design;

FIG. 2 is a front view thereof;

FIG. 3 is a right side view thereof;

FIG. 4 is a rear view thereof;

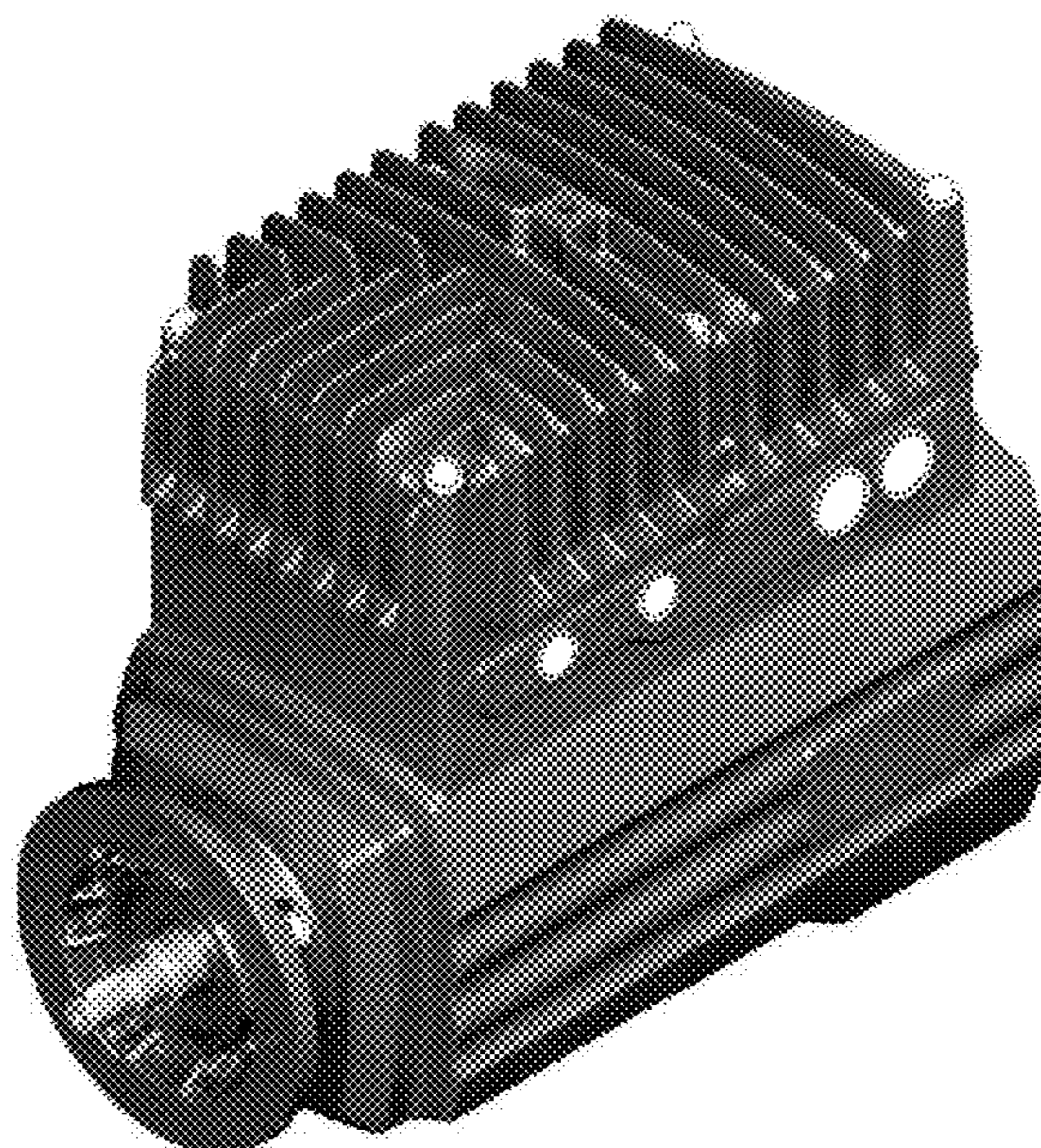
FIG. 5 is a left side view thereof;

FIG. 6 is a top view thereof; and,

FIG. 7 is a bottom view thereof.

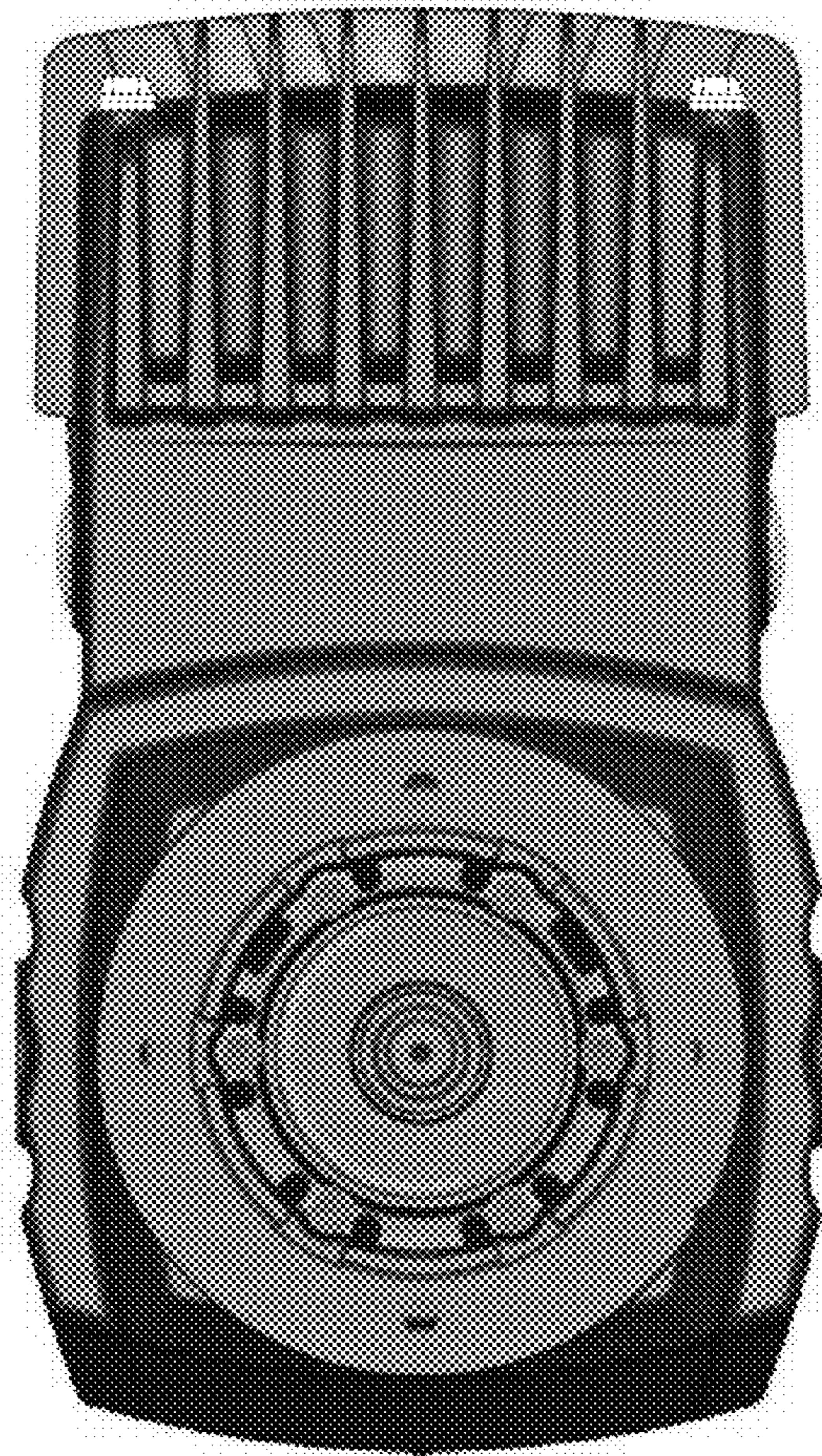
The elements depicted in broken lines are environment and form no part of the claimed design.

**1 Claim, 7 Drawing Sheets**

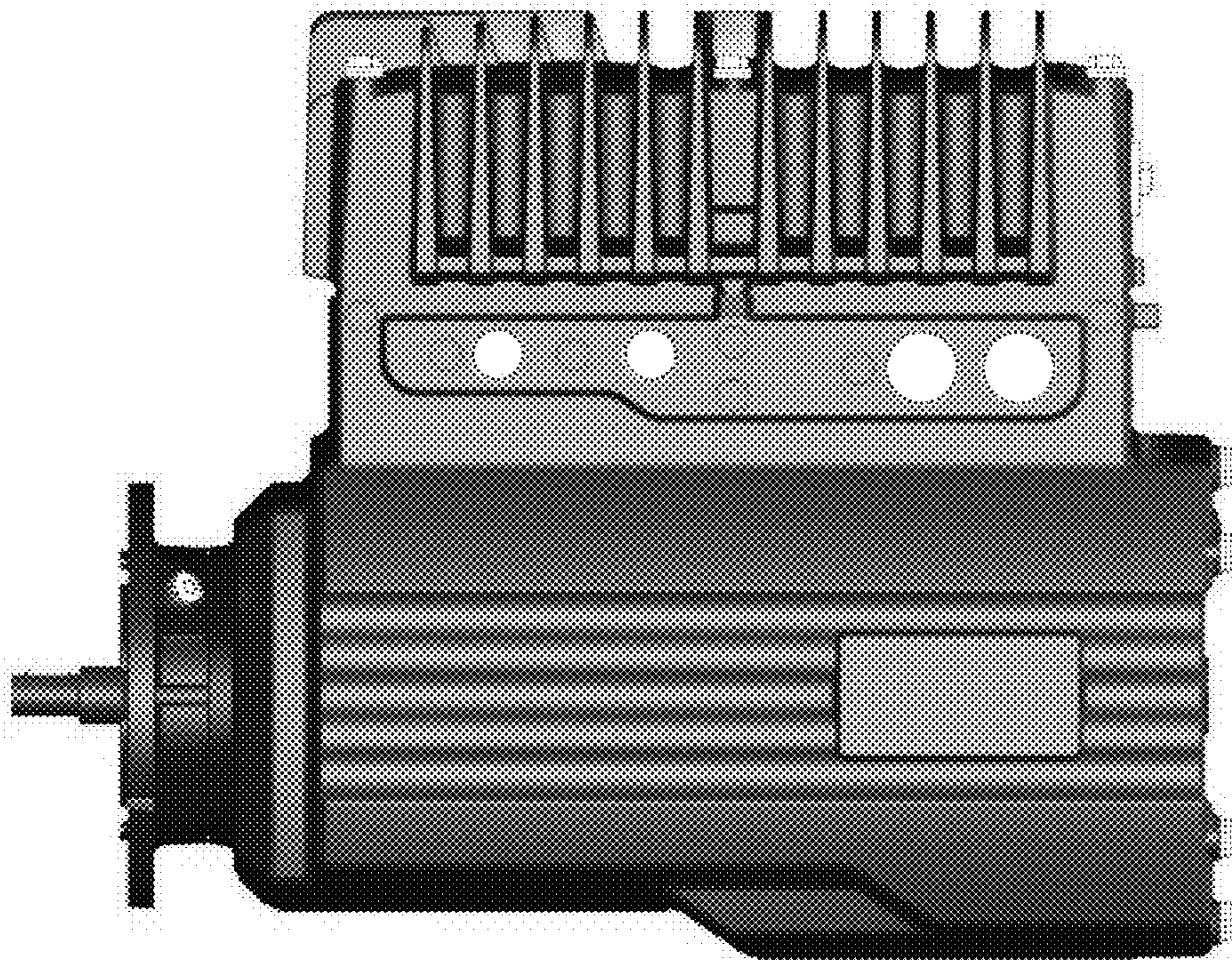




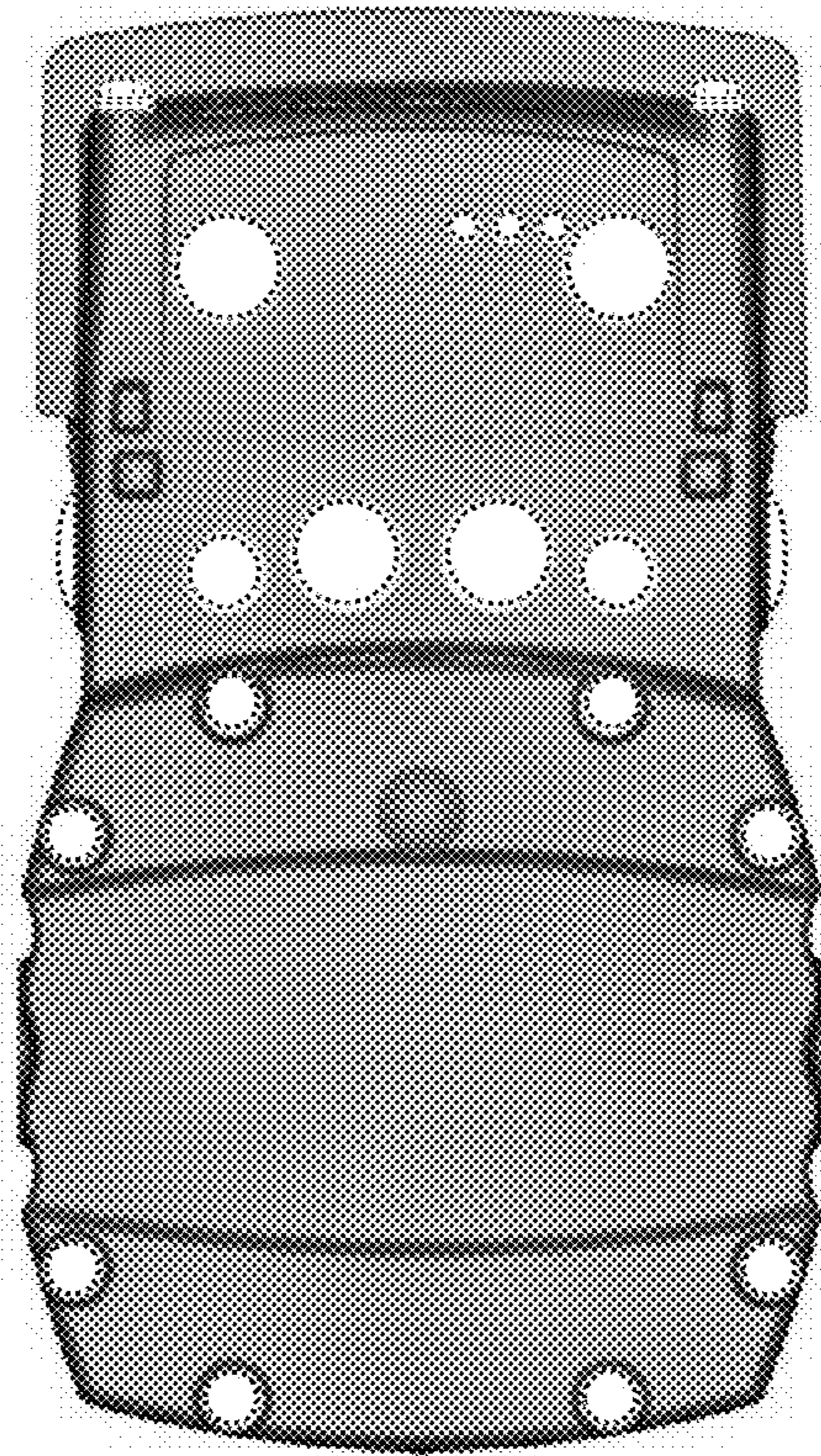
**FIG. 1**



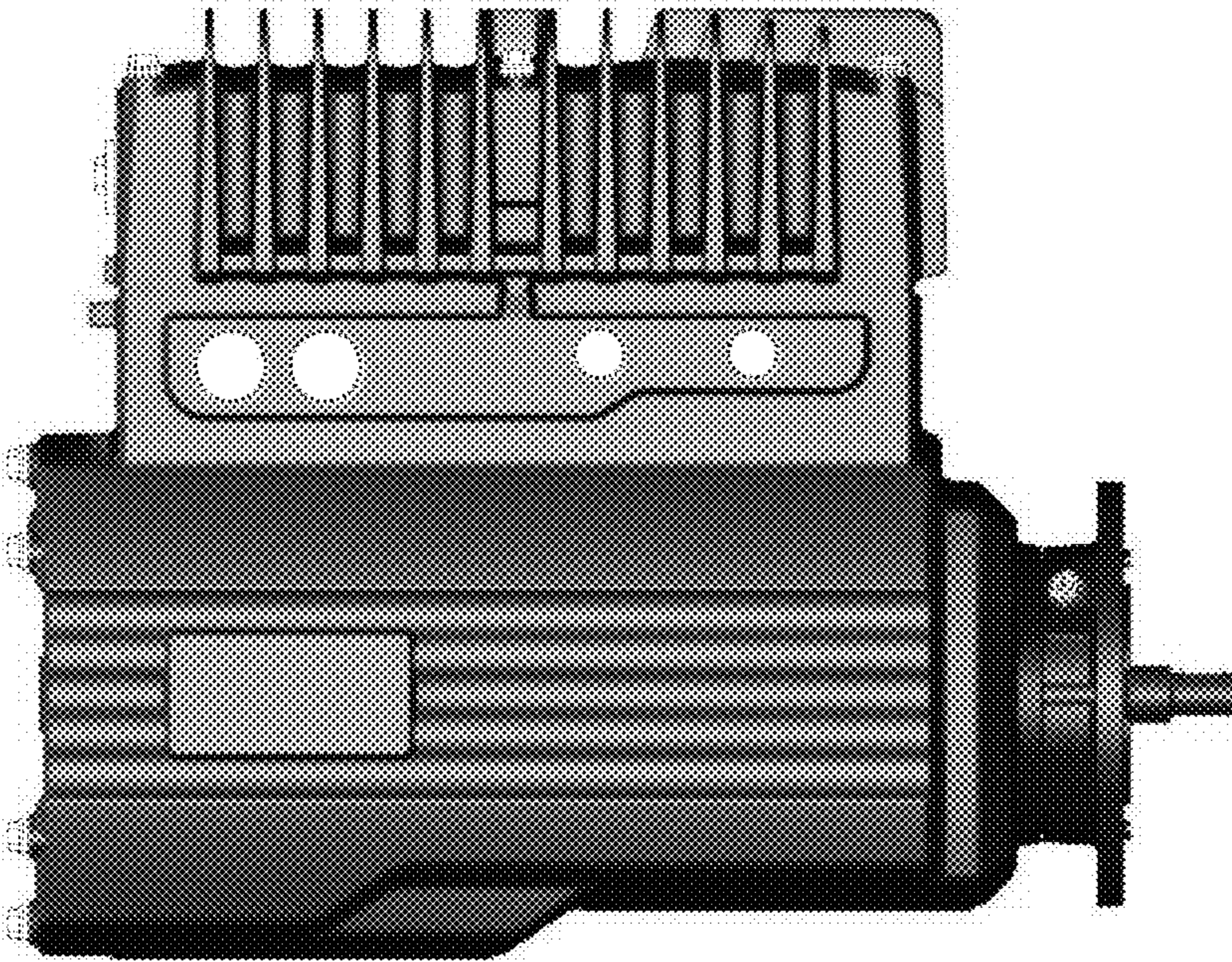
**FIG. 2**



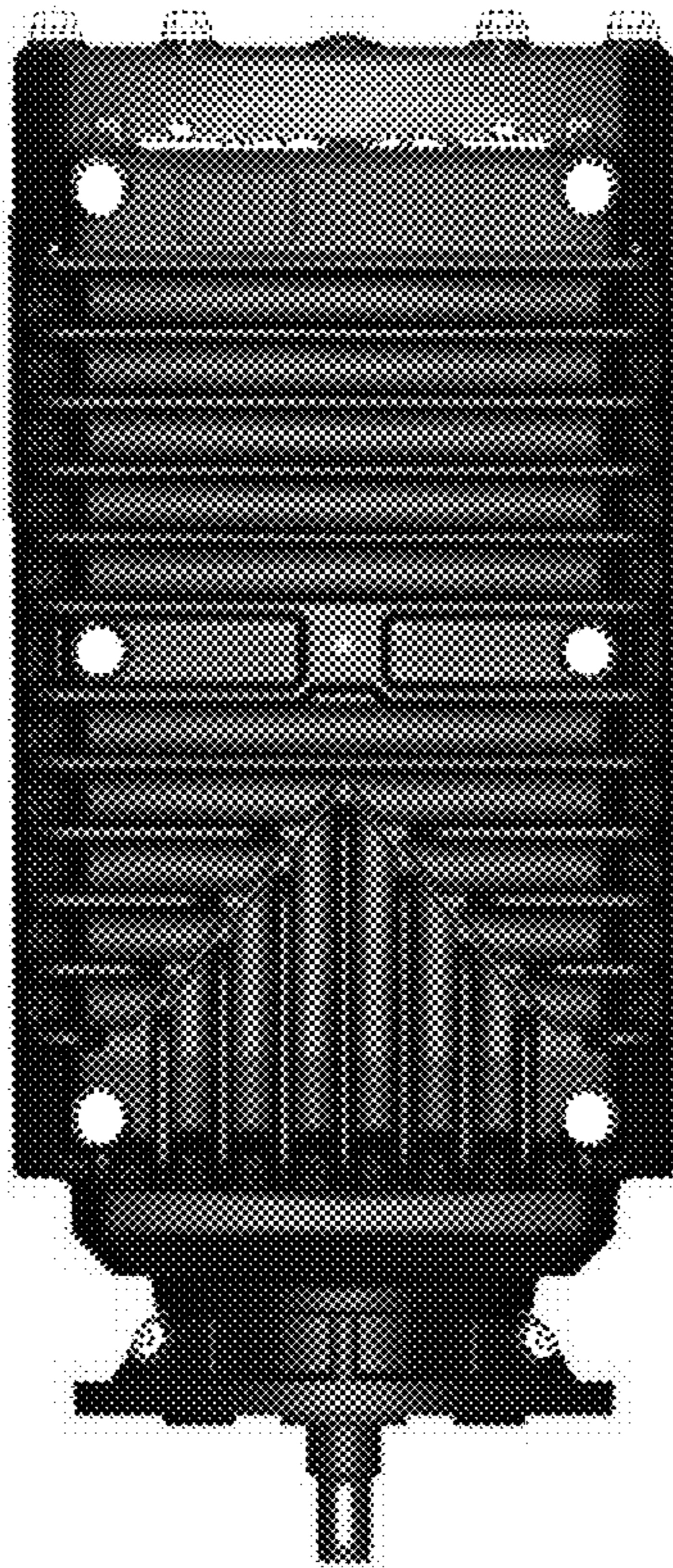
**FIG. 3**



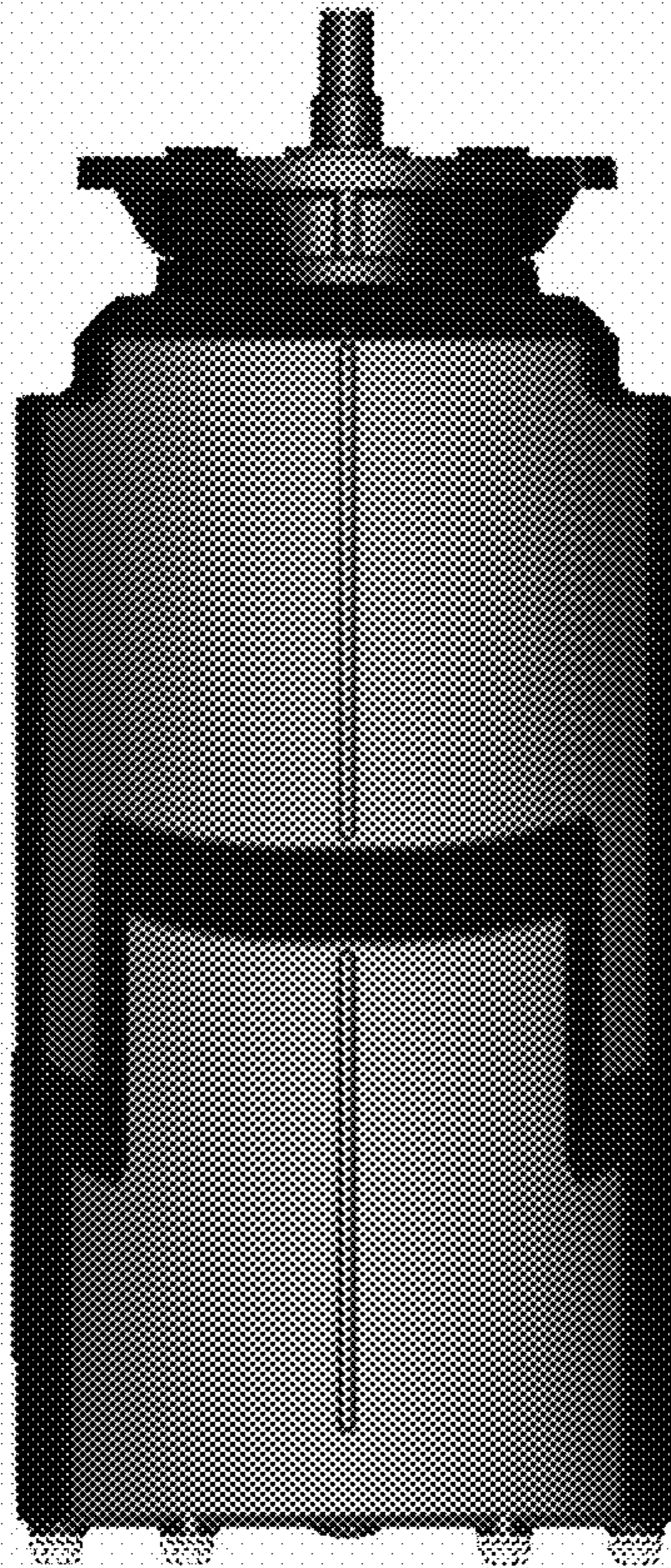
**FIG. 4**



**FIG. 5**



**FIG. 6**



**FIG. 7**



UNITED STATES PATENT AND TRADEMARK OFFICE  
**CERTIFICATE OF CORRECTION**

PATENT NO. : D713,338 S  
APPLICATION NO. : 29/465654  
DATED : September 16, 2014  
INVENTOR(S) : Hans-Jürgen Lannoch et al.

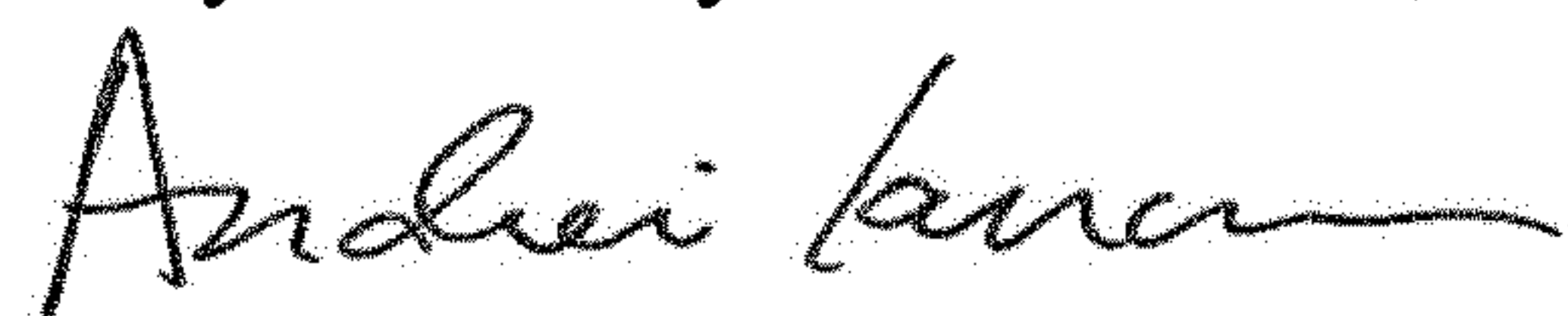
Page 1 of 1

It is certified that error appears in the above-identified patent and that said Letters Patent is hereby corrected as shown below:

On the Title Page

Item (73), Assignee: "Sew-Europe GmbH & Co. KG" should read -- Sew-Eurodrive GmbH & Co. KG  
--.

Signed and Sealed this  
Twenty-sixth Day of November, 2019



Andrei Iancu  
*Director of the United States Patent and Trademark Office*