



US00D713303S

(12) **United States Design Patent**  
**Nishio**

(10) **Patent No.:** **US D713,303 S**  
(45) **Date of Patent:** **\*\* Sep. 16, 2014**

(54) **FRONT GRILLE FOR AN AUTOMOBILE**

FOREIGN PATENT DOCUMENTS

(71) Applicant: **Aisin Seiki Kabushiki Kaisha**, Kariya (JP)

JP 2010223150 A \* 10/2010

(72) Inventor: **Yasuaki Nishio**, Kariya (JP)

(73) Assignee: **Aisin Seiki Kabushiki Kaisha**, Kariya-Shi, Aichi-Ken (JP)

OTHER PUBLICATIONS

2014 Lexus IS, announced Jun. 2013, [online], [site visited Dec. 9, 2013]. Available from Internet, <URL: <http://www.lexus.com/lexus-share/v2/img/PDF/Lexus-IS-Brochure.pdf>>.\*

(Continued)

(\*\*) Term: **14 Years**

*Primary Examiner* — Eric Goodman

(21) Appl. No.: **29/460,324**

*Assistant Examiner* — Jennifer Watkins

(22) Filed: **Jul. 10, 2013**

(74) *Attorney, Agent, or Firm* — Buchanan Ingersoll & Rooney PC

(30) **Foreign Application Priority Data**

(57) **CLAIM**

Jan. 10, 2013 (JP) ..... 2013-000277

The ornamental design for a front grille for an automobile, as shown and described.

(51) **LOC (10) CL.** ..... **12-16**

**DESCRIPTION**

(52) **U.S. CL.**  
USPC ..... **D12/163**

(58) **Field of Classification Search**  
USPC ..... D12/169, 196, 171, 163, 216, 90-92,  
D12/86; 296/180.1, 180.2; 293/102, 113,  
293/115, 117, 120; 180/68.1, 68.6  
See application file for complete search history.

FIG. 1 is a perspective view of a front grille for an automobile showing my new design;  
FIG. 2 is a front view thereof;  
FIG. 3 is a rear view thereof;  
FIG. 4 is a top plan view thereof;  
FIG. 5 is a bottom plan view thereof;  
FIG. 6 is a right side view thereof;  
FIG. 7 is a left side view thereof;  
FIG. 8 is a perspective view thereof with the shutter in an open position;  
FIG. 9 is a front view of FIG. 8;  
FIG. 10 is a rear view of FIG. 8;  
FIG. 11 is a top plan view of FIG. 8;  
FIG. 12 is a bottom plan view of FIG. 8;  
FIG. 13 is a right side view of FIG. 8; and,  
FIG. 14 is a left side view of FIG. 8.

(56) **References Cited**

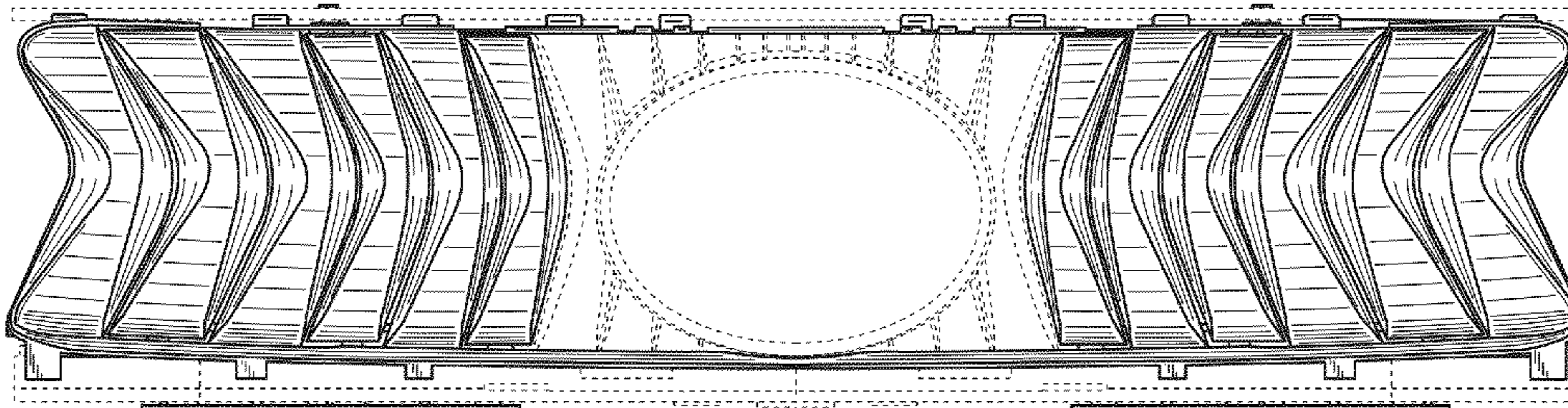
U.S. PATENT DOCUMENTS

3,333,525	A *	8/1967	Tischuk	.....	454/281
D287,843	S *	1/1987	Katoh et al.	.....	D12/163
5,880,394	A *	3/1999	Kim	.....	89/36.02
D507,214	S *	7/2005	Marchese et al.	.....	D12/163
D524,199	S *	7/2006	Fukuda et al.	.....	D12/163
D558,102	S *	12/2007	Lau et al.	.....	D12/163
D558,104	S *	12/2007	Hieke	.....	D12/163
D572,178	S *	7/2008	Zheng	.....	D12/163
D587,636	S *	3/2009	Kanno et al.	.....	D12/163

The broken lines in the drawings are for the purpose of illustrating environment and form no part of the claimed design.

(Continued)

**1 Claim, 14 Drawing Sheets**



(56)

**References Cited**

**OTHER PUBLICATIONS**

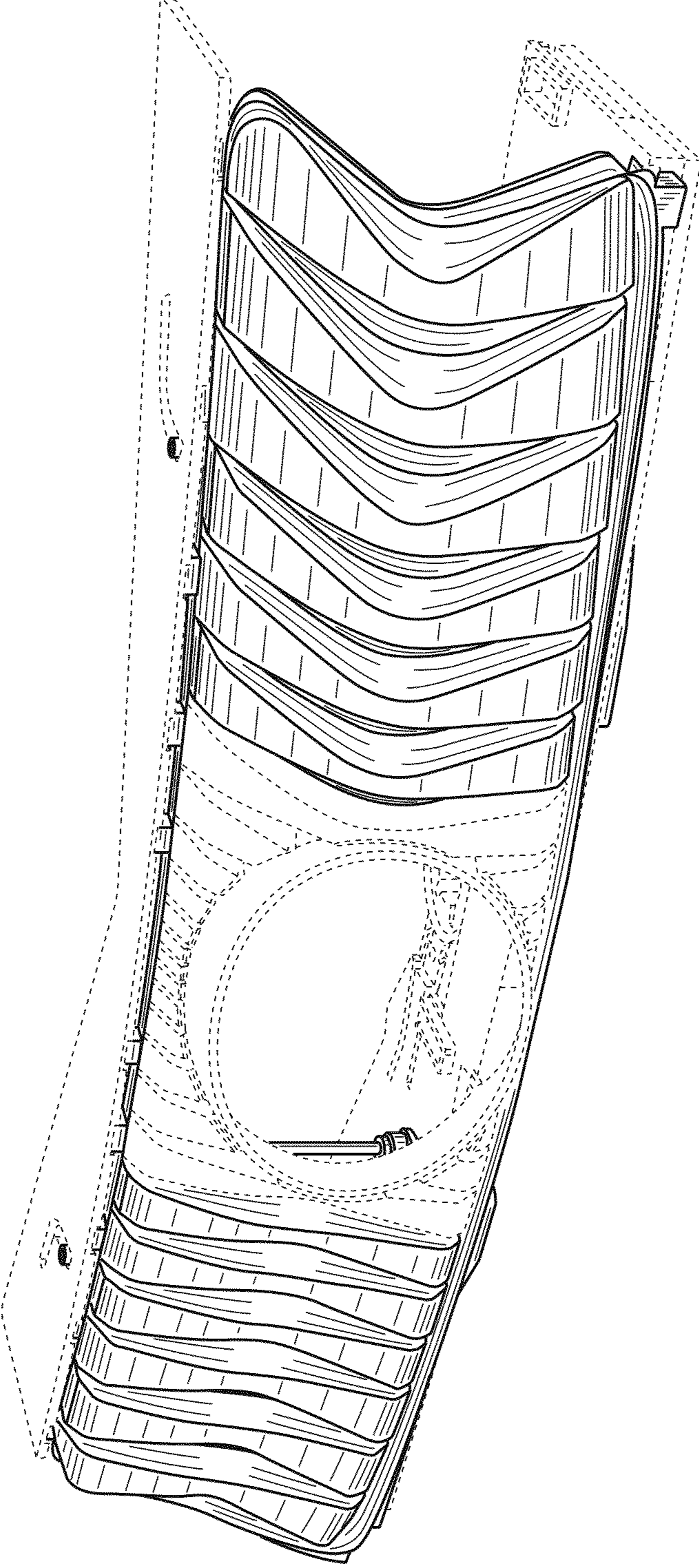
U.S. PATENT DOCUMENTS

D596,998	S	*	7/2009	Hasui	.....	D12/163
D608,697	S	*	1/2010	Takabatake	.....	D12/163
D626,464	S	*	11/2010	Yanase et al.	.....	D12/163
D627,692	S	*	11/2010	Cheng	.....	D12/163
D683,668	S	*	6/2013	Thurber	.....	D12/163
2013/0092463	A1	*	4/2013	Hori	.....	180/68.1

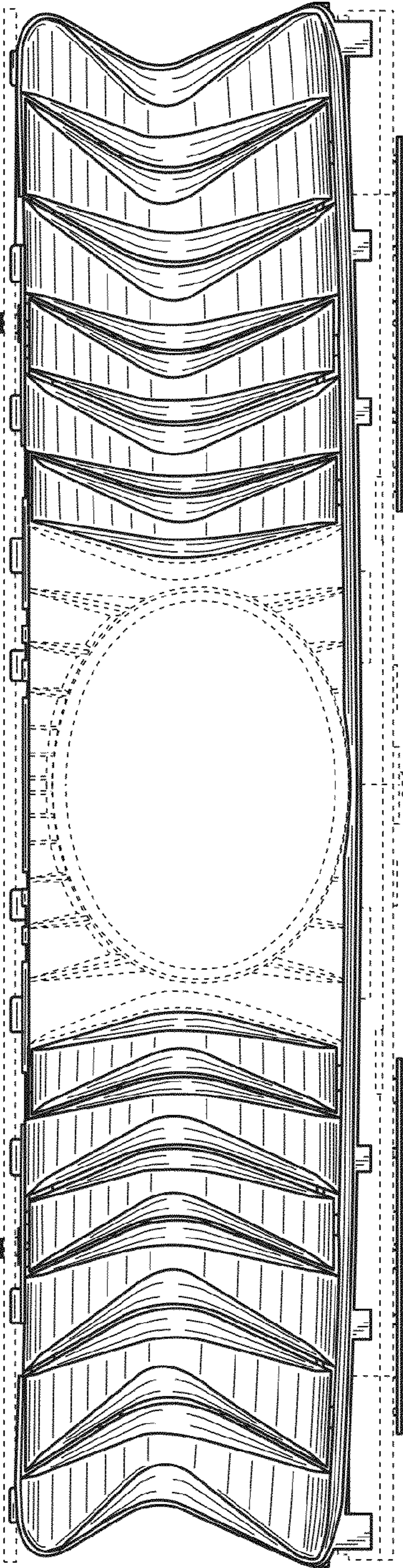
2014 BMW 2 Series Coupe, announced Oct. 2013, [online], [site visited Dec. 9, 2013]. Available from Internet, <URL: <http://www.bmw.com/com/en/newvehicles/2series/coupe/2013/showroom/index.html>>.\*

\* cited by examiner

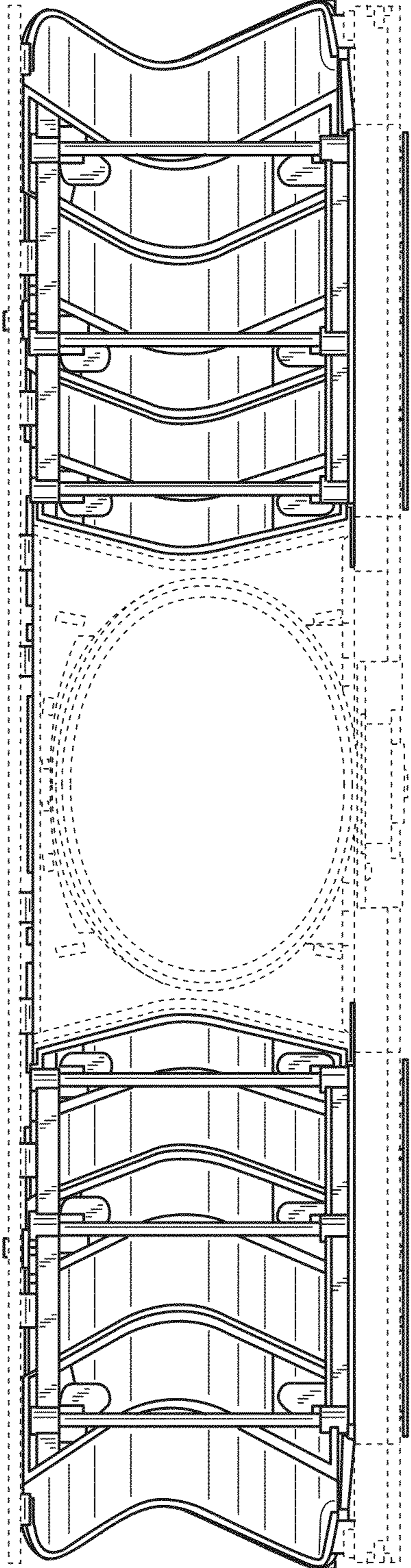
**FIG. 1**



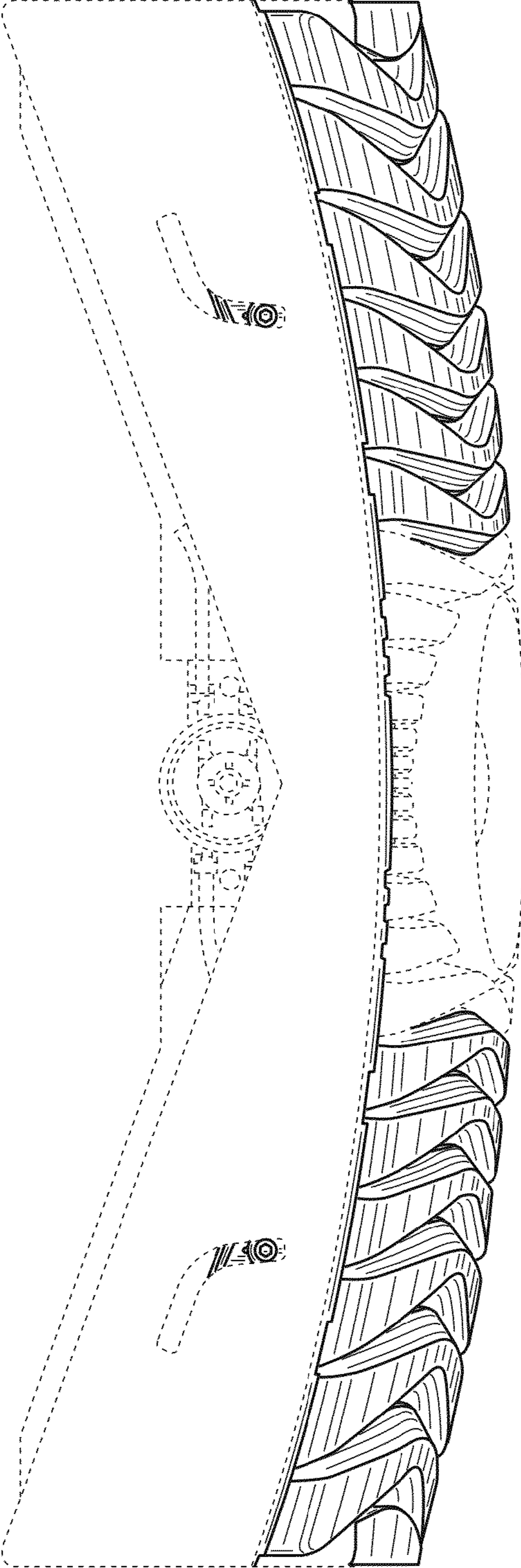
*FIG. 2*



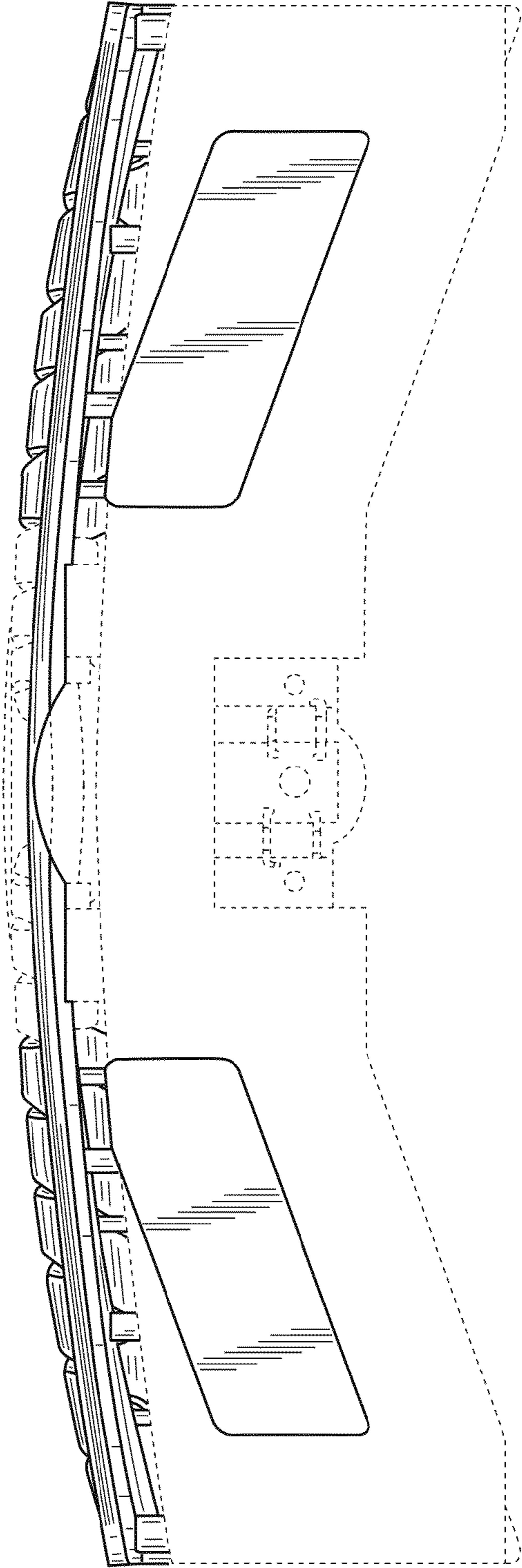
**FIG. 3**



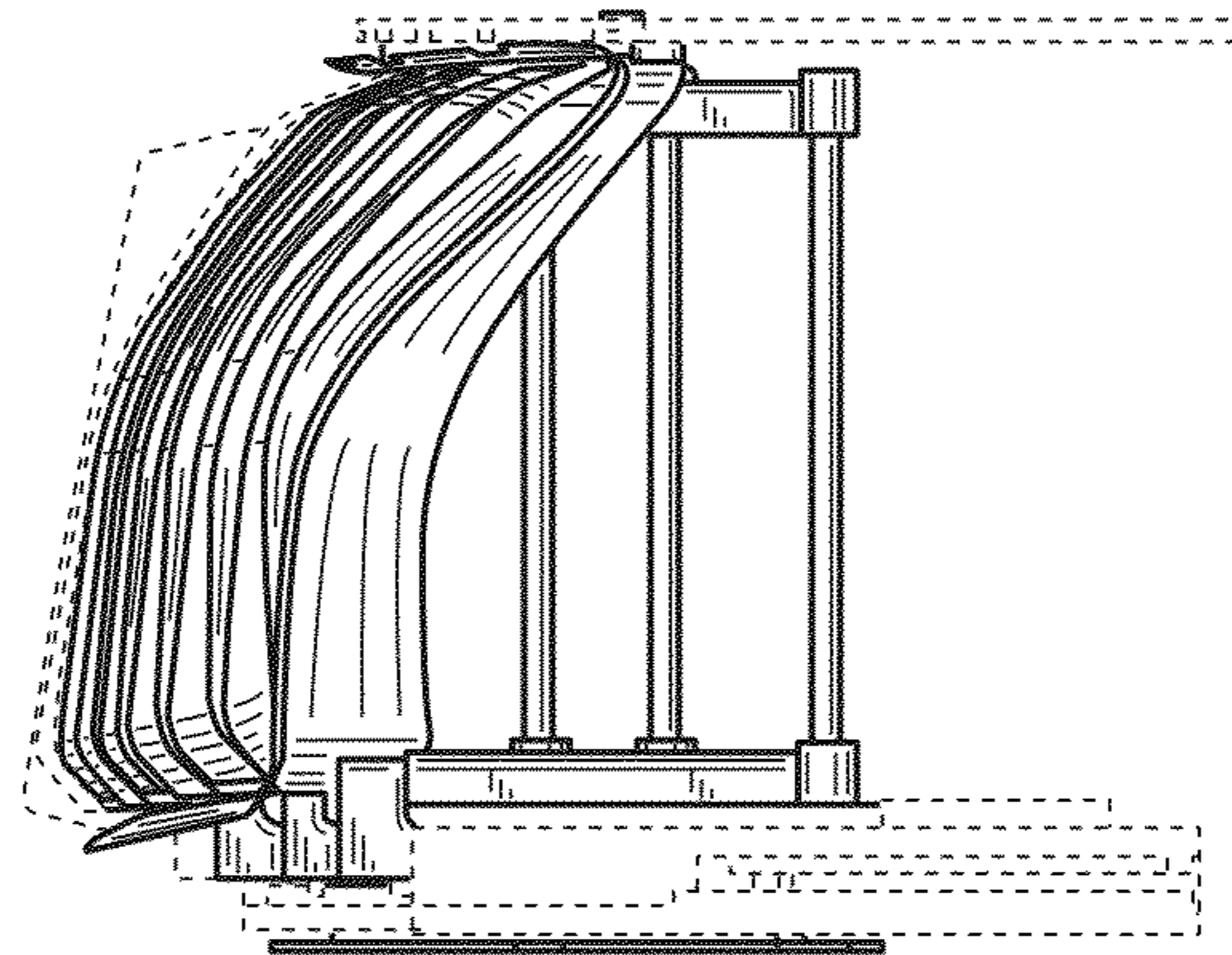
**FIG. 4**



**FIG. 5**

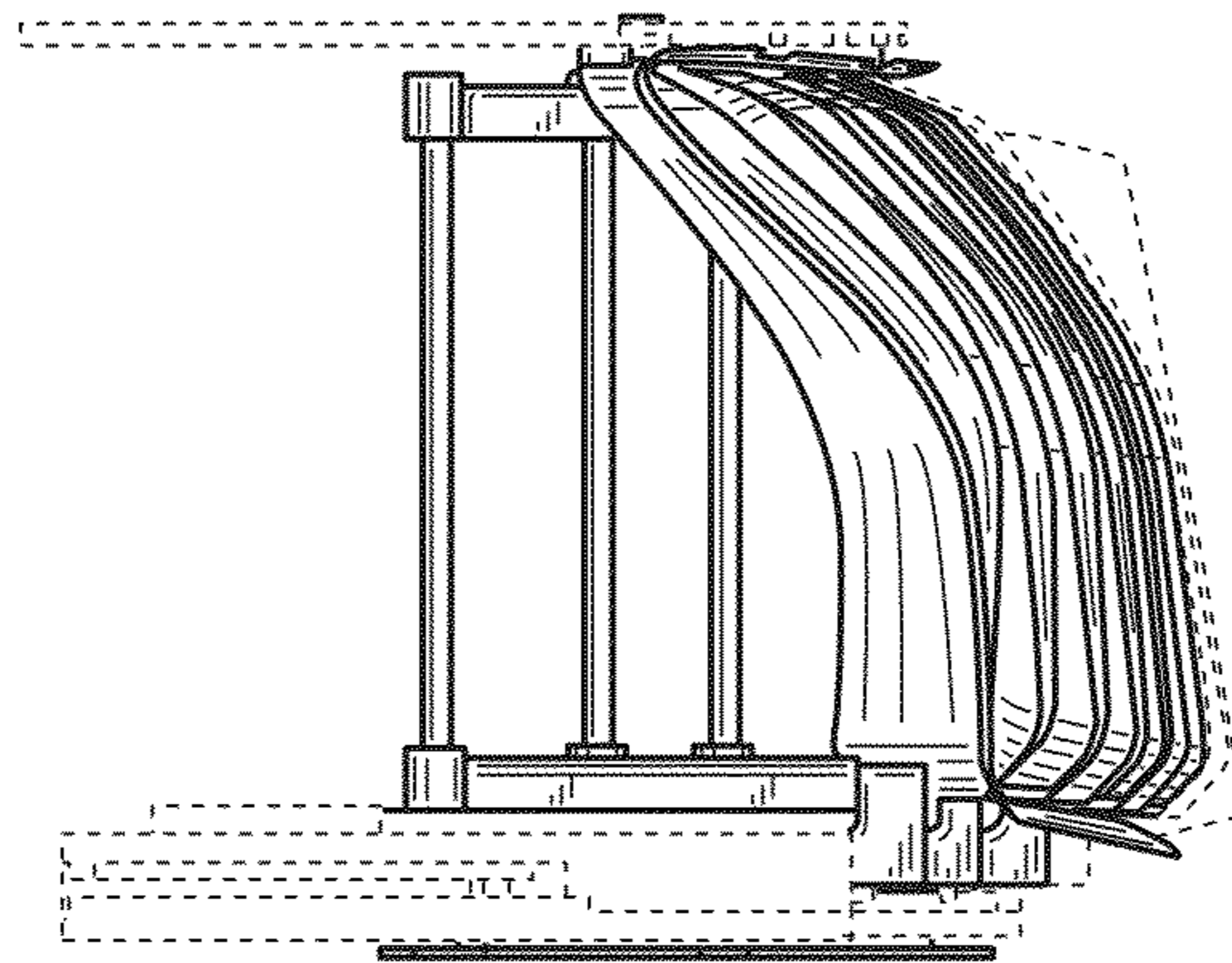


*FIG. 6*

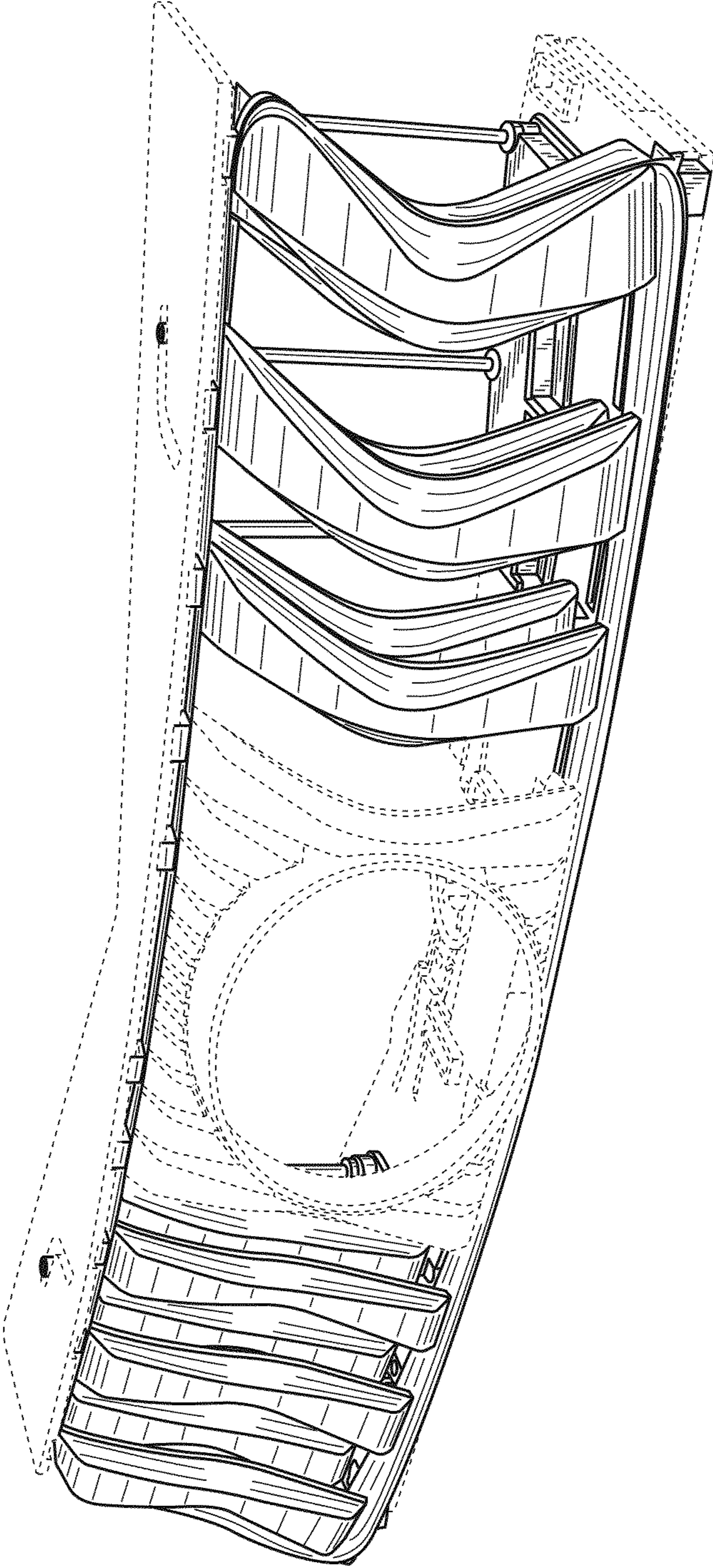




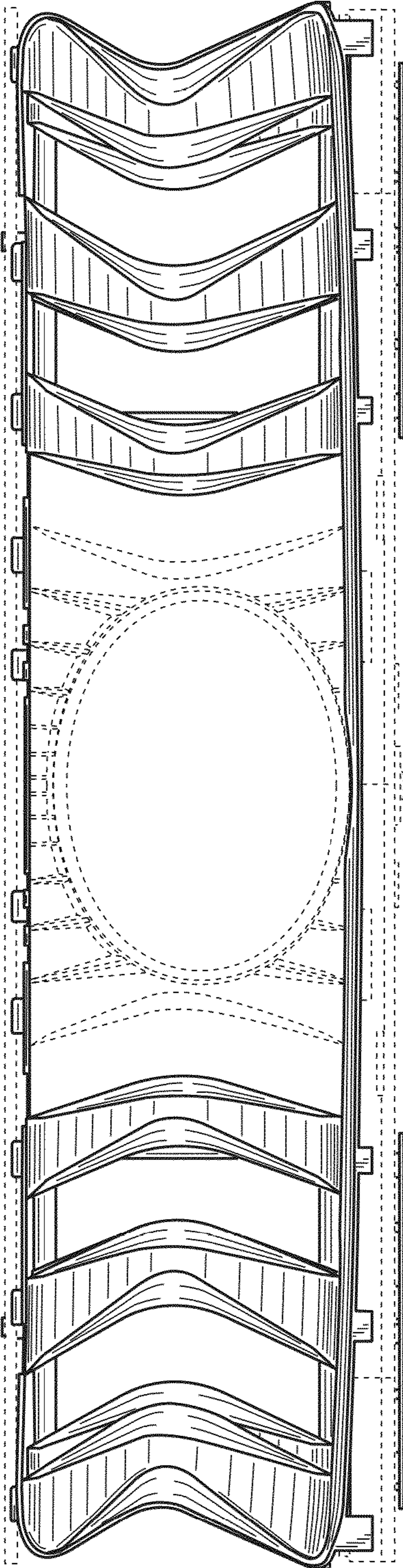
*FIG. 7*



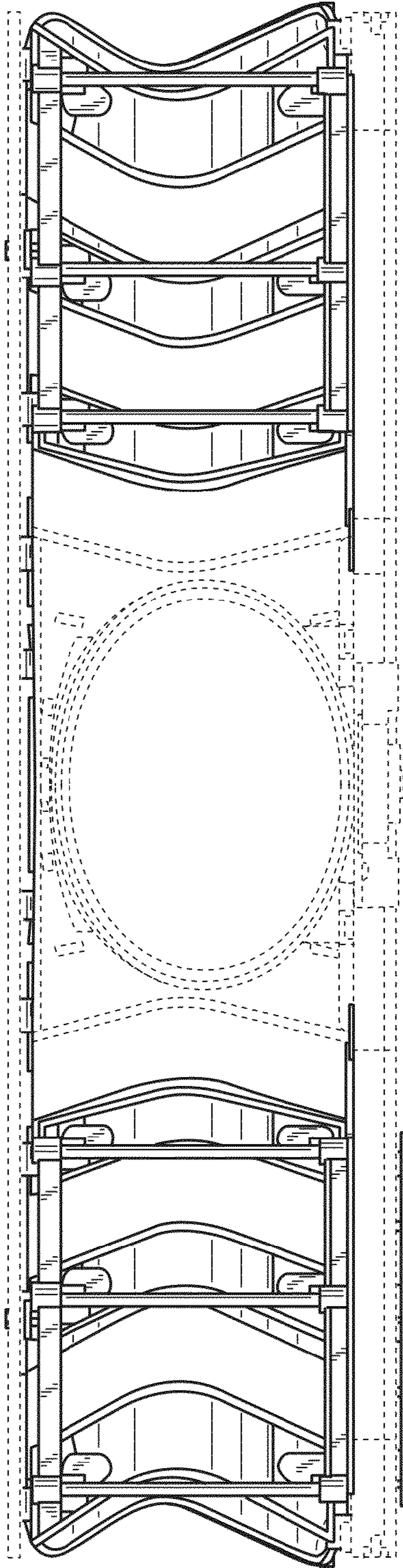
*FIG. 8*



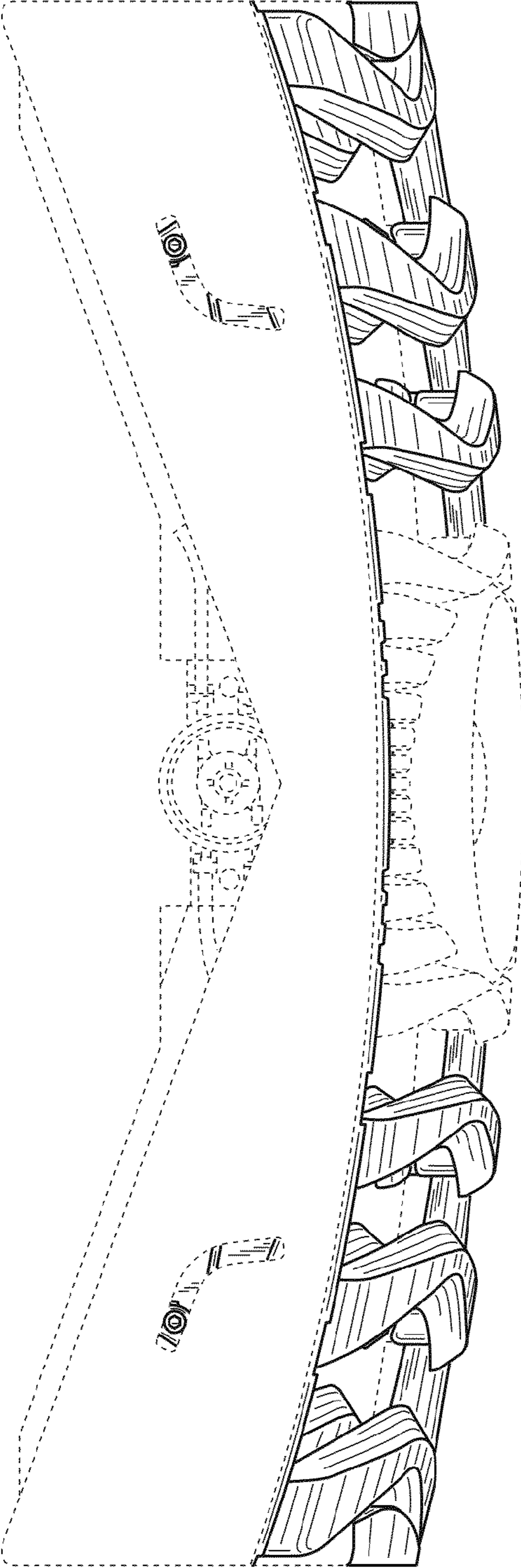
**FIG. 9**



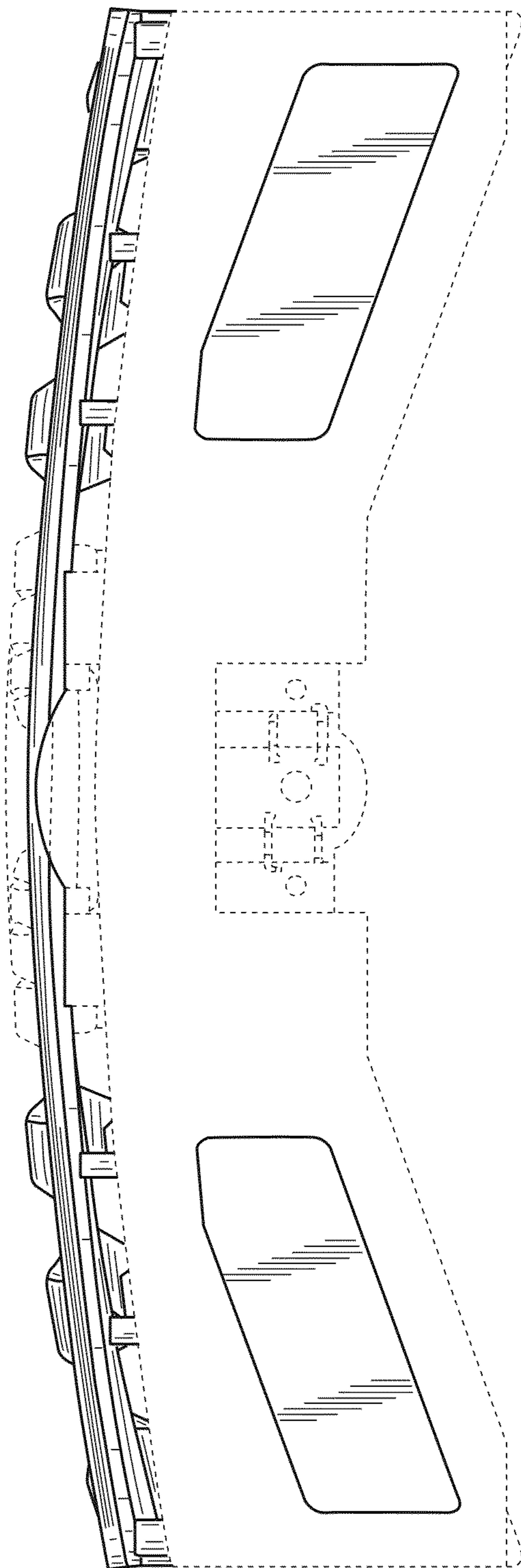
*FIG. 10*



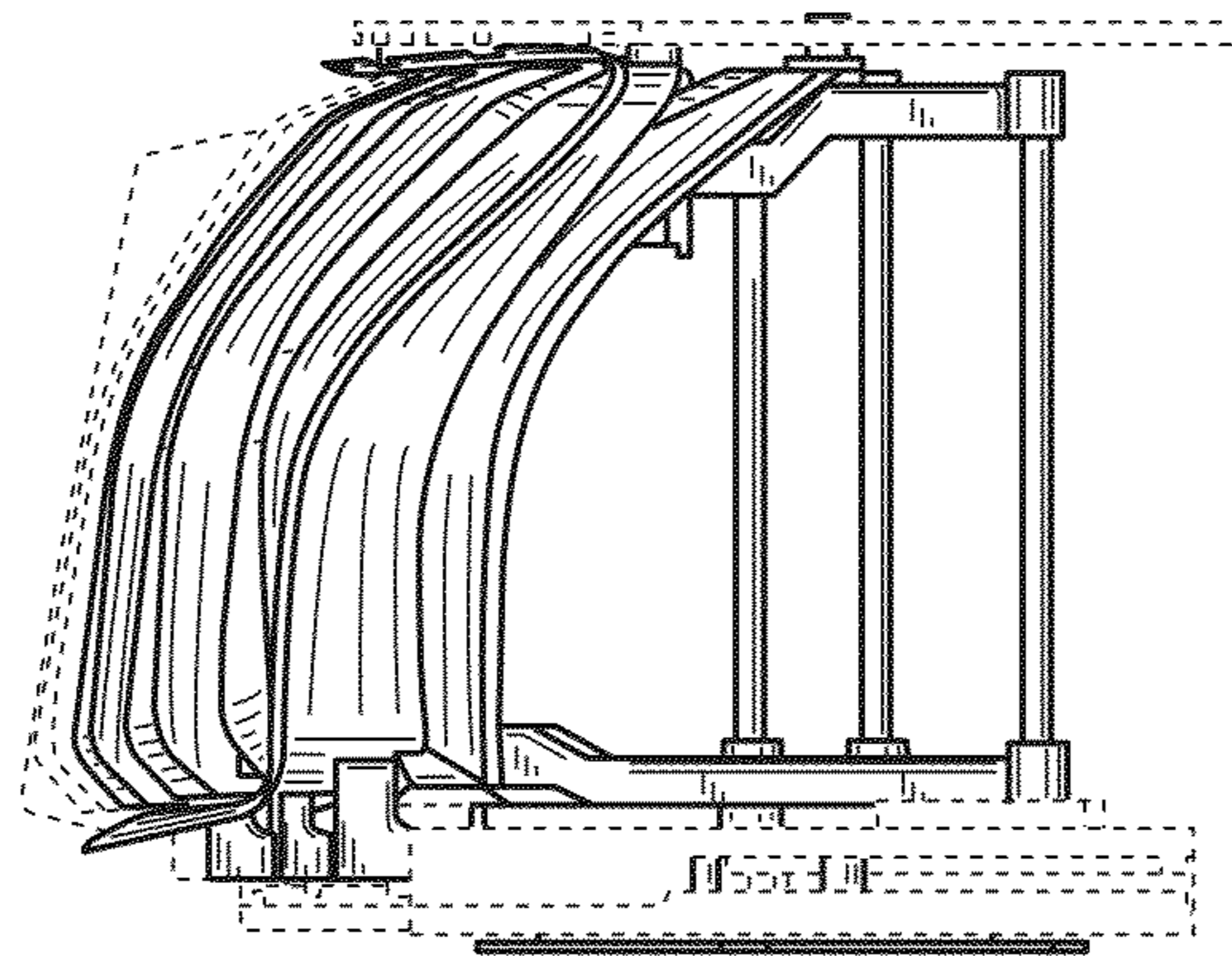
*FIG. 11*



**FIG. 12**



*FIG. 13*



*FIG. 14*

