



US00D713279S

(12) **United States Design Patent**
Fukuoka et al.

(10) **Patent No.:** **US D713,279 S**

(45) **Date of Patent:** **** Sep. 16, 2014**

(54) **CLOCK MOVEMENT**

(75) Inventors: **Shigeru Fukuoka**, Saitama (JP);
Hiroshi Kabe, Saitama (JP)

(73) Assignee: **Rhythm Watch Co., Ltd.**, Saitama (JP)

(**) Term: **14 Years**

(21) Appl. No.: **29/431,795**

(22) Filed: **Sep. 11, 2012**

(30) **Foreign Application Priority Data**

Jul. 9, 2012 (JP) 2012-016231

(51) **LOC (10) CL.** **10-07**

(52) **U.S. Cl.**
USPC **D10/129**

(58) **Field of Classification Search**
CPC G04C 3/00; G04C 3/02; G04C 3/008;
G04C 3/027; G04C 1/04; G04C 5/00; G04B
45/0053; H05K 1/18
USPC D10/1-29, 122-132; 368/76, 88, 134,
368/159, 300; 185/40 R
See application file for complete search history.

(56) **References Cited**

U.S. PATENT DOCUMENTS

3,067,838 A * 12/1962 Gluck 185/40 R
3,981,139 A * 9/1976 Jackle 368/159
4,276,634 A * 6/1981 Assmus et al. 368/300
4,316,277 A * 2/1982 Endo 368/76

4,416,550 A * 11/1983 Wolber et al. 368/88
4,465,378 A * 8/1984 Maurer et al. 368/88
4,829,495 A * 5/1989 Kaneko et al. 368/134
D318,024 S * 7/1991 Kaneko D10/129
D318,026 S * 7/1991 Moritaka D10/129
D318,027 S * 7/1991 Moritaka D10/129
D326,064 S * 5/1992 Matsuda D10/129
D333,999 S * 3/1993 Hatano D10/129
D335,100 S * 4/1993 Goto et al. D10/129
D335,101 S * 4/1993 Goto D10/129
D357,885 S * 5/1995 Matsuda D10/129
D630,120 S * 1/2011 Nishi et al. D10/129

* cited by examiner

Primary Examiner — Martie K Holtje

(74) *Attorney, Agent, or Firm* — Kubotera & Associates, LLC

(57) **CLAIM**

The ornamental design for a clock movement, as shown and described.

DESCRIPTION

FIG. 1 is a perspective view of a clock movement showing our new design;
FIG. 2 is a front view thereof;
FIG. 3 is a rear view thereof;
FIG. 4 is a right side view thereof;
FIG. 5 is a left side view thereof;
FIG. 6 is a plan view thereof; and,
FIG. 7 is a bottom view thereof.

1 Claim, 6 Drawing Sheets

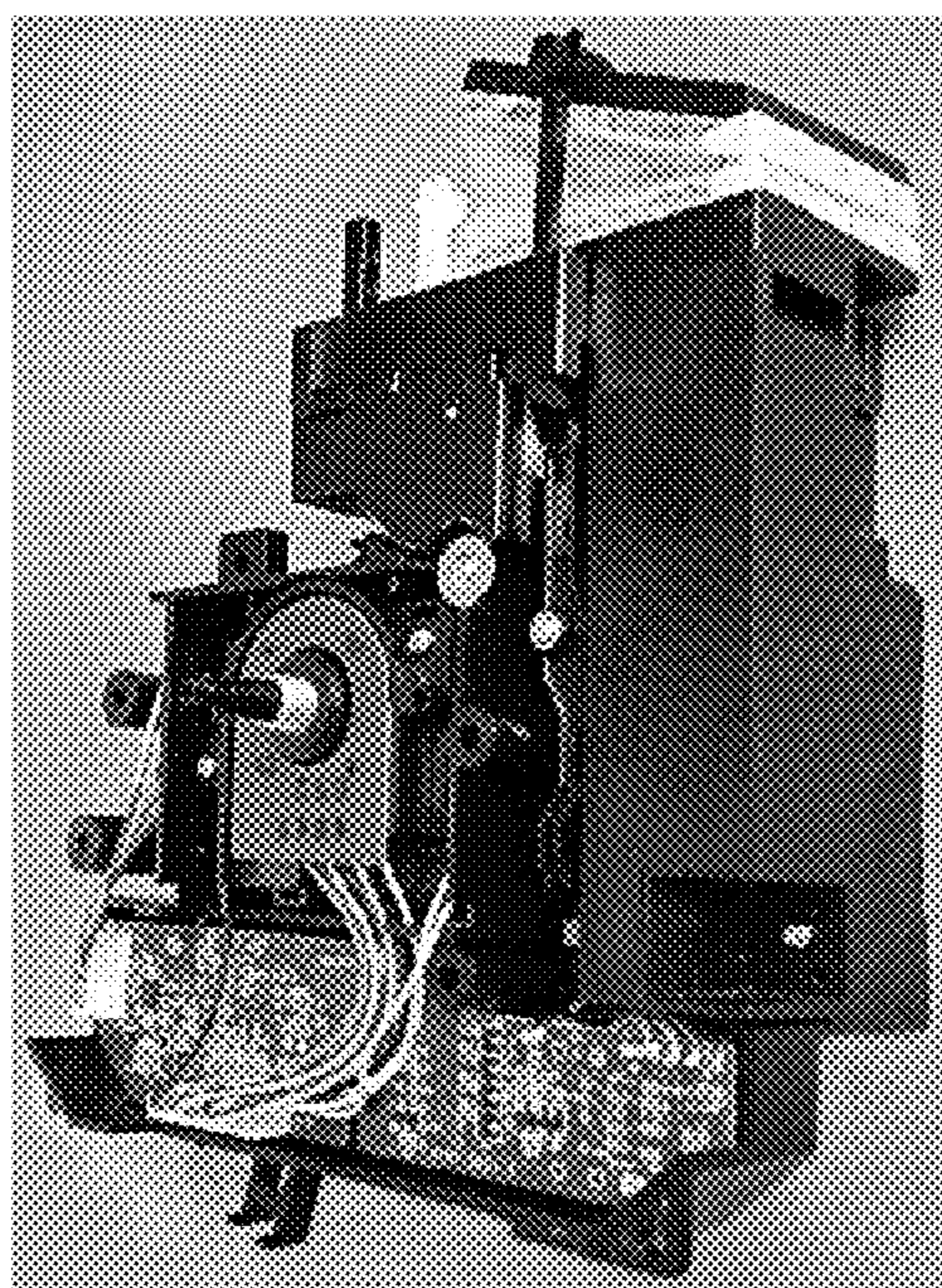

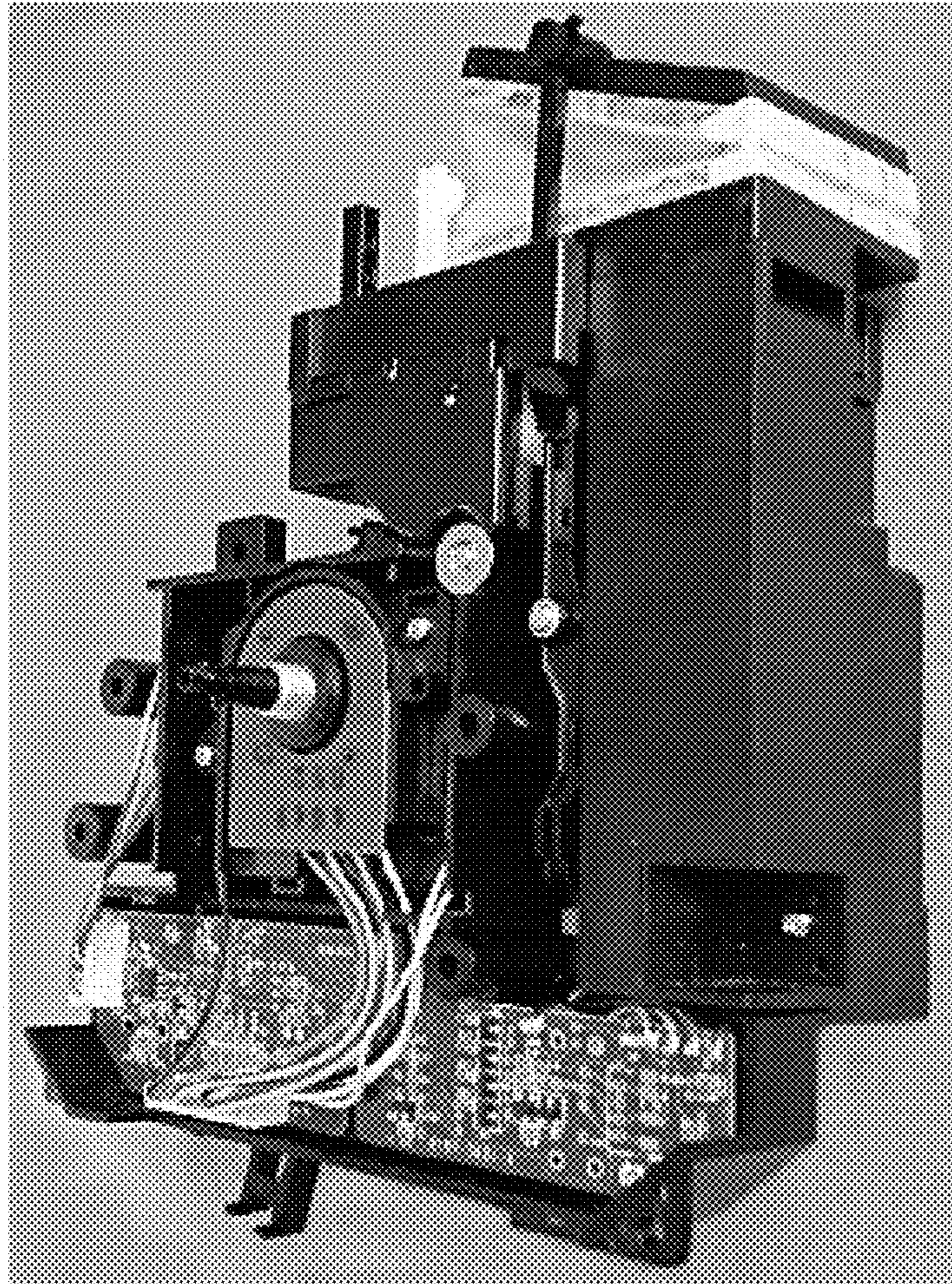

FIG. 1

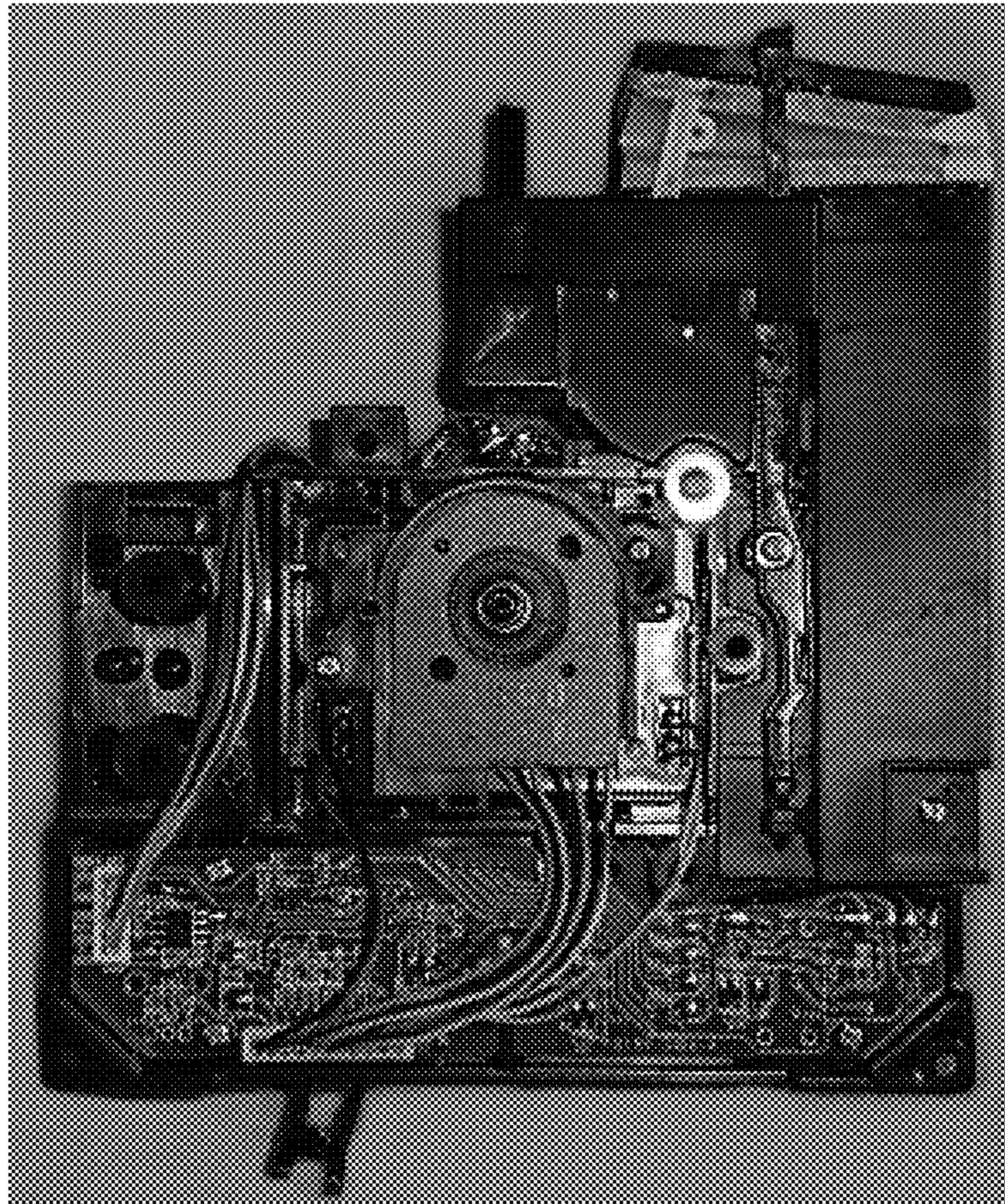

FIG. 2

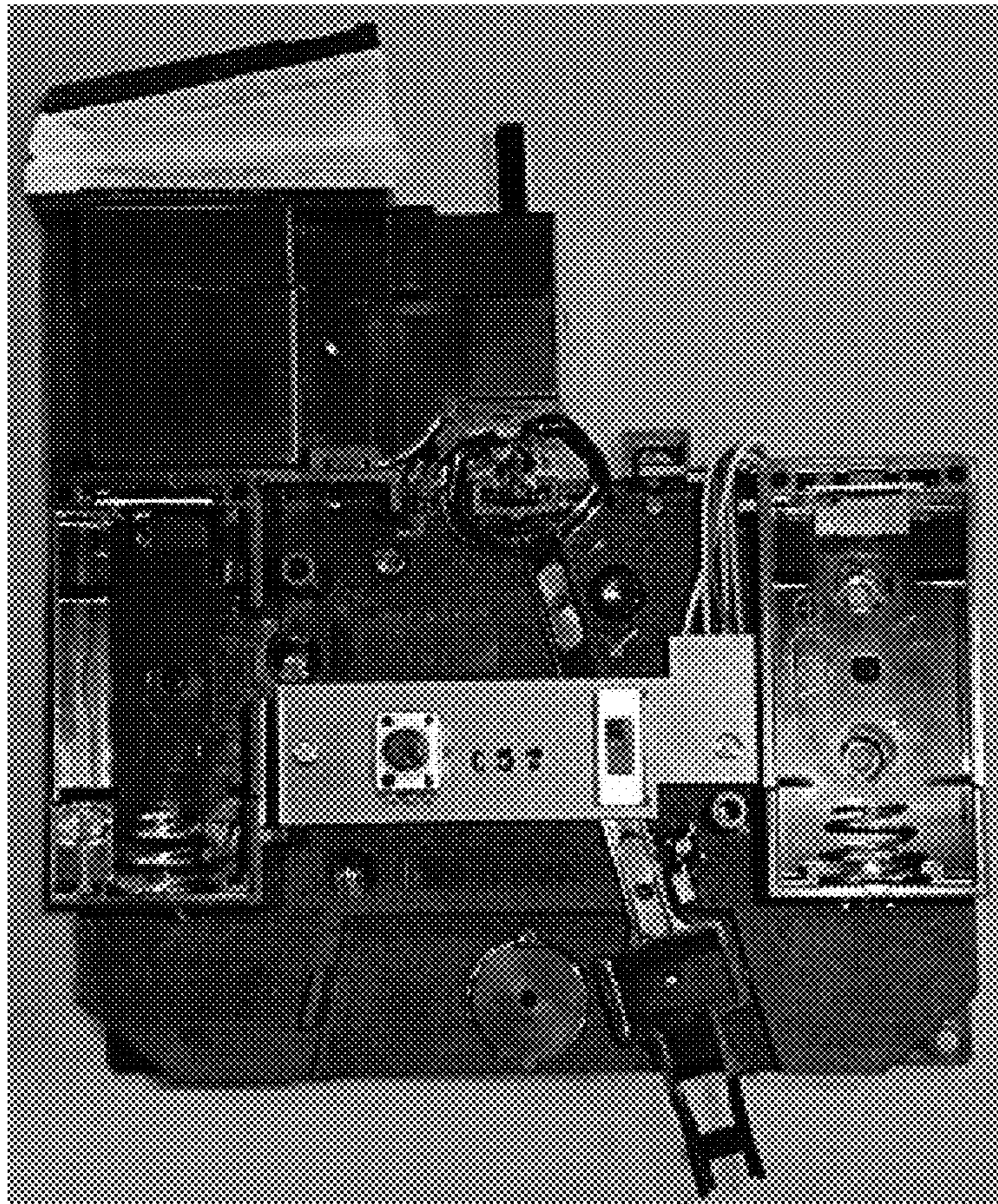

FIG. 3

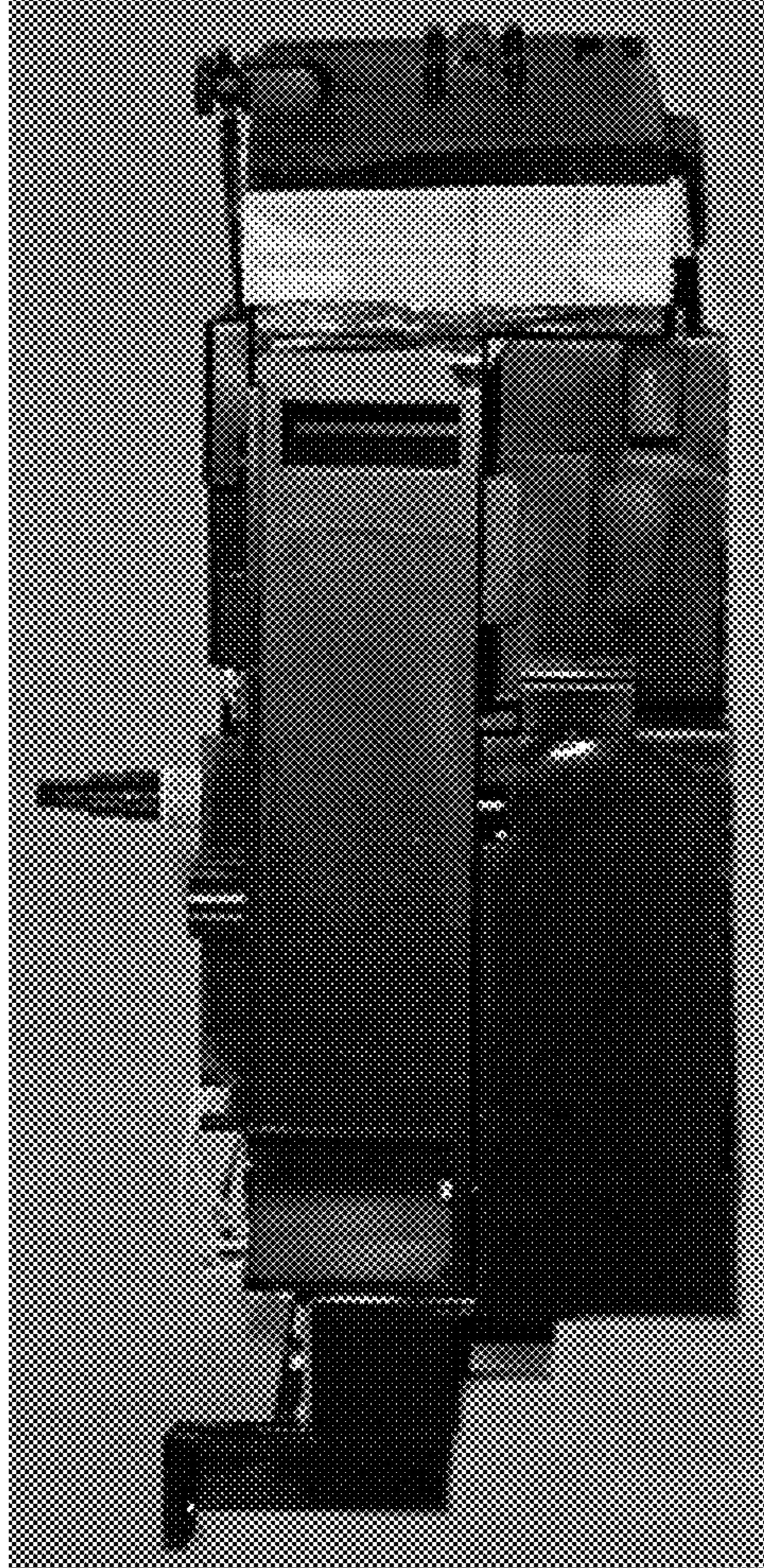

FIG. 4

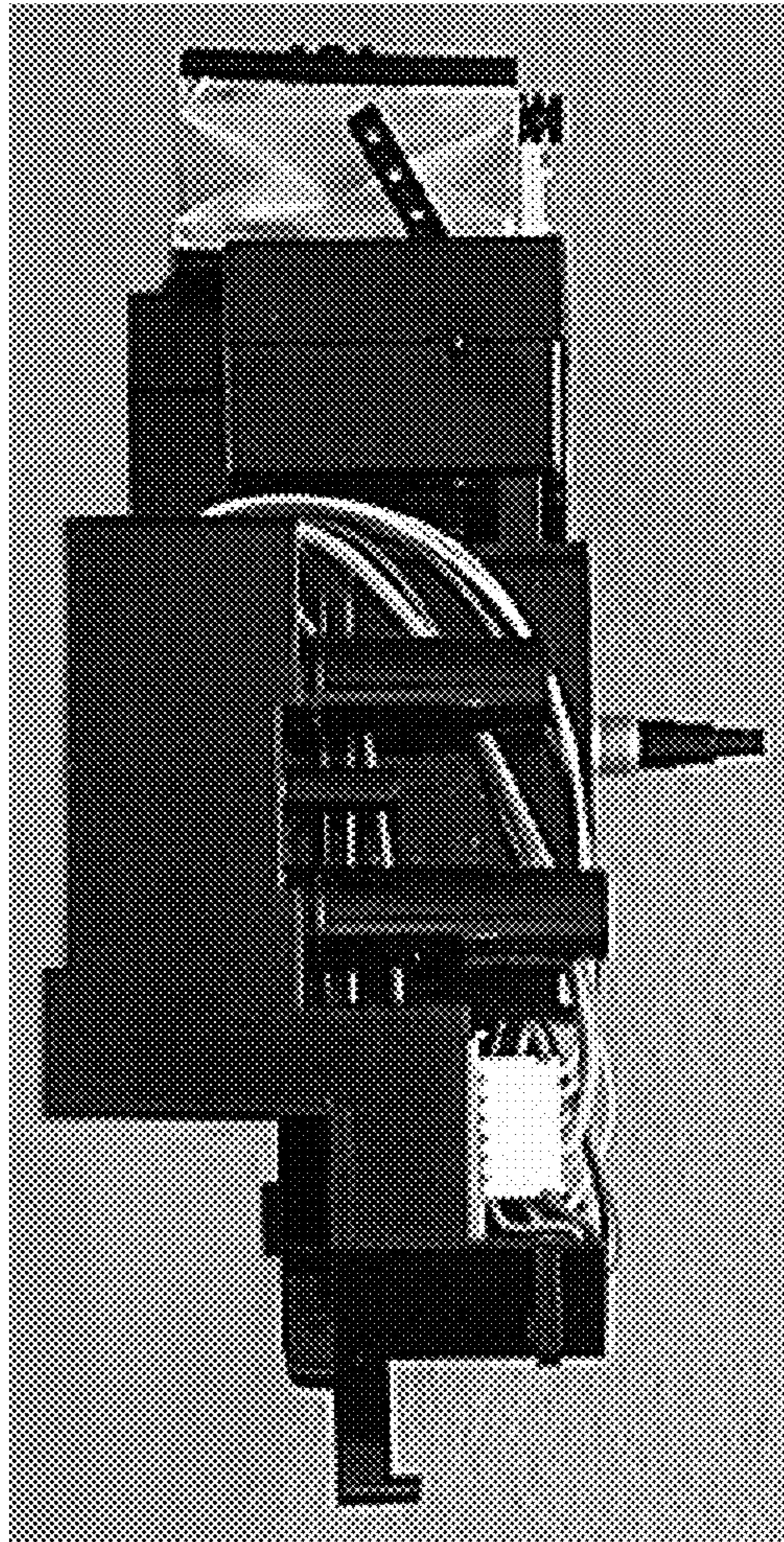

FIG. 5

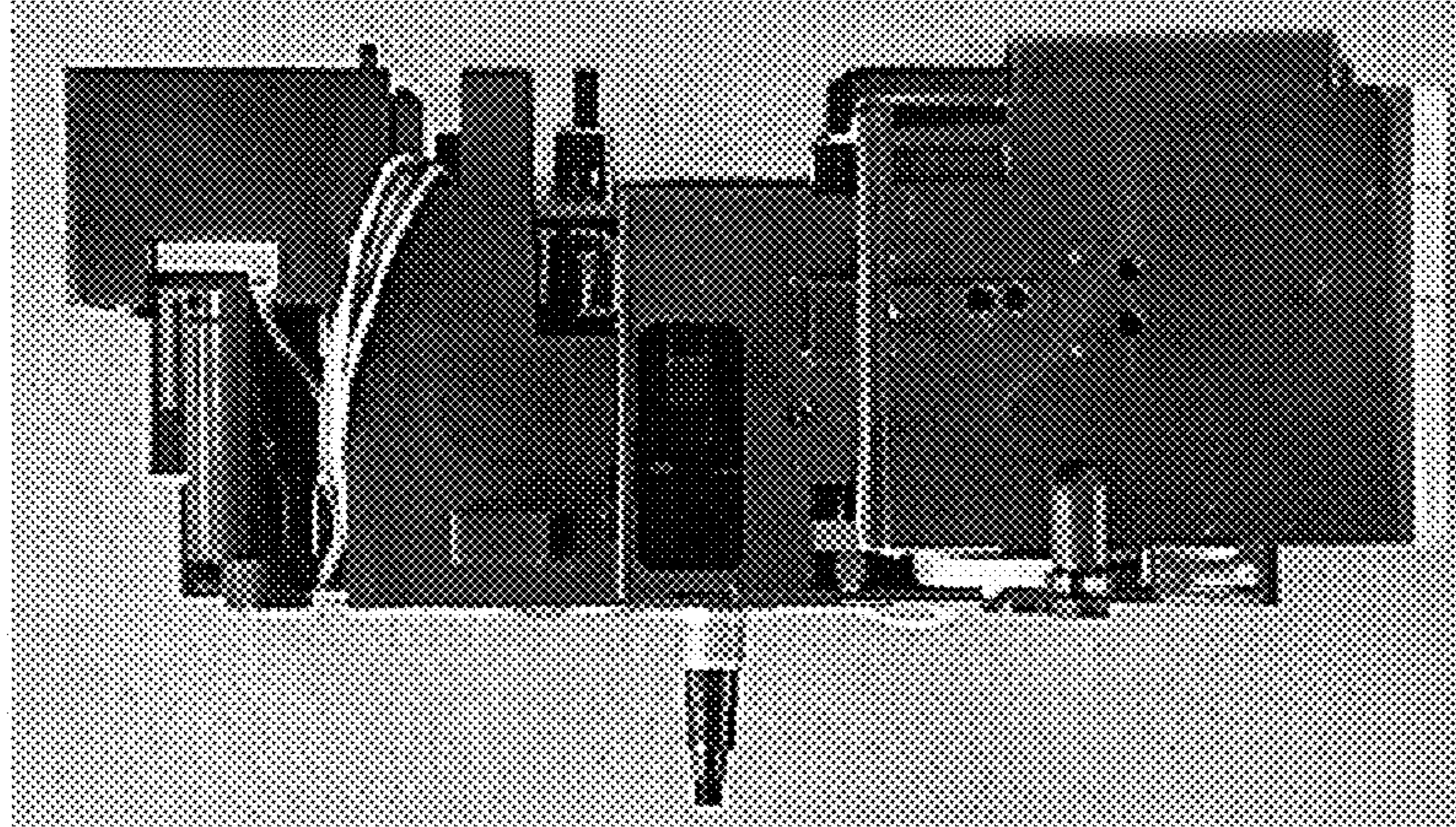

FIG. 6

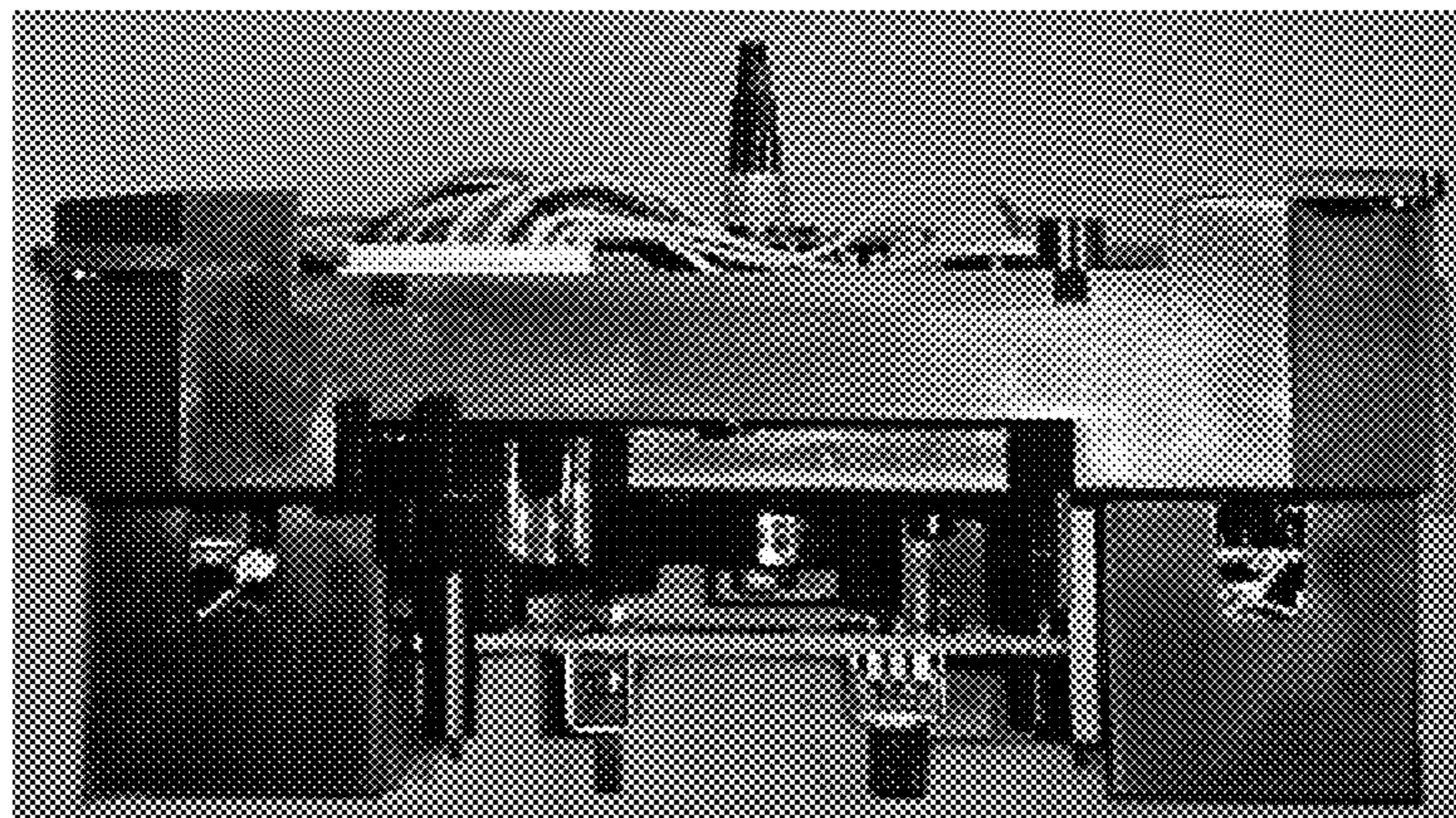

FIG. 7