



US00D713220S

(12) **United States Design Patent**
Cloutier et al.

(10) **Patent No.:** **US D713,220 S**

(45) **Date of Patent:** **** Sep. 16, 2014**

(54) **SCRAPER SPATULA**

(71) Applicant: **Magellan Group, Ltd.**, Blaine, WA (US)

(72) Inventors: **Andre Dean Cloutier**, Blaine, WA (US);
Adriana Collins, Blaine, WA (US);
Debra Lynne Sasken-Duff, Blaine, WA (US);
Justin Riehl, Blaine, WA (US)

(73) Assignee: **Magellan Group, Ltd.**, Blaine, WA (US)

(**) Term: **14 Years**

(21) Appl. No.: **29/435,513**

(22) Filed: **Oct. 24, 2012**

(51) **LOC (10) Cl.** **07-02**

(52) **U.S. Cl.**
USPC **D7/688**

(58) **Field of Classification Search**
USPC D7/688, 669, 689, 691, 368; D32/40,
D32/46; 15/245.1, 236.01, 236.07; 294/7, 8;
416/22, 3 R, 231 A, 231 B
See application file for complete search history.

(56) **References Cited**

U.S. PATENT DOCUMENTS

D360,561 S *	7/1995	Littledeer	D7/688
D388,286 S *	12/1997	Fox	D7/653
D498,989 S *	11/2004	White et al.	D7/688
D618,070 S *	6/2010	Jalet et al.	D7/691
D628,448 S *	12/2010	Genatossio	D7/691
2007/0050986 A1 *	3/2007	Foster et al.	30/142

* cited by examiner

Primary Examiner — Terry Wallace

(74) *Attorney, Agent, or Firm* — Dwayne E. Rogge; Schacht Law Office, Inc.

(57) **CLAIM**

The ornamental design for a scraper spatula, as shown and described.

DESCRIPTION

FIG. 1 is an isometric view of the scraper spatula thereof.
 FIG. 2 is a rear view thereof.
 FIG. 3 is a front view thereof.
 FIG. 4 is top view thereof.
 FIG. 5 is bottom view thereof.
 FIG. 6 is a left side view thereof.
 FIG. 7 is a right side view thereof.
 FIG. 8 is a front detail view showing contours thereof.
 FIG. 9 is a rear detail view showing contours thereof.
 FIG. 10 is a section surface view taken along line 10-10 of FIG. 2.
 FIG. 11 is a section surface view taken along line 11-11 of FIG. 2.
 FIG. 12 is an isometric view of a second embodiment of the scraper spatula thereof.
 FIG. 13 is a rear view thereof.
 FIG. 14 is a front view thereof.
 FIG. 15 is a top view thereof.
 FIG. 16 is a bottom view thereof.
 FIG. 17 is a left side view thereof.
 FIG. 18 is a right side view thereof.
 FIG. 19 is a front detail view showing contours thereof.
 FIG. 20 is a rear detail view showing contours thereof.
 FIG. 21 is a section surface view taken along line 21-21 of FIG. 13; and,
 FIG. 22 is a section surface view taken along line 22-22 of FIG. 13.

Any broken lines shown in the drawings are for illustrative purposes only and form no part of the claimed design.

1 Claim, 13 Drawing Sheets

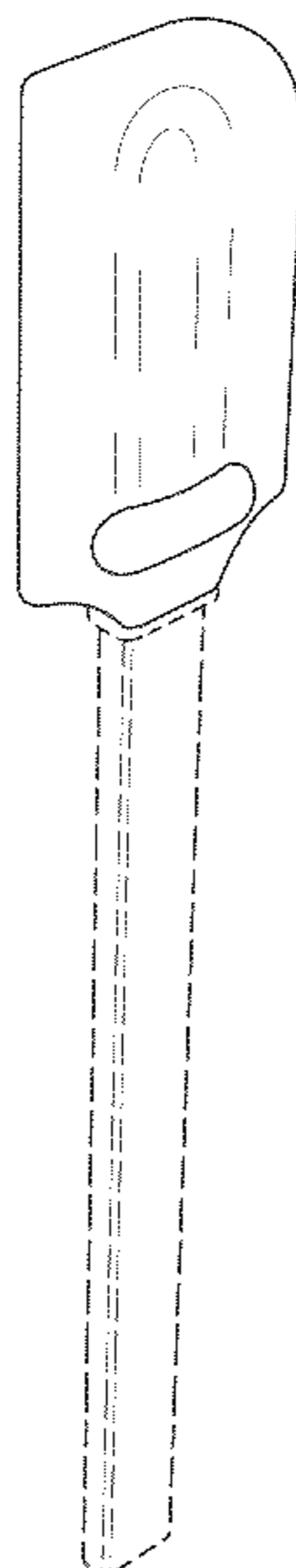

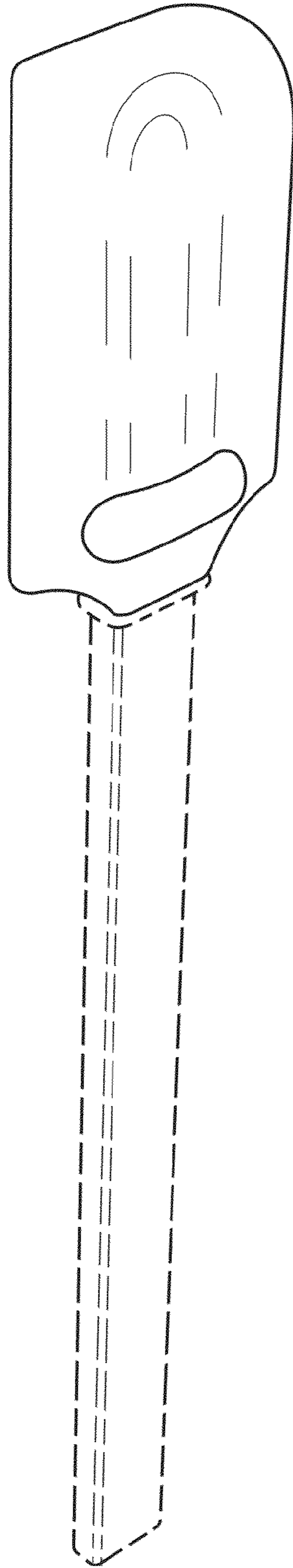

Fig. 1

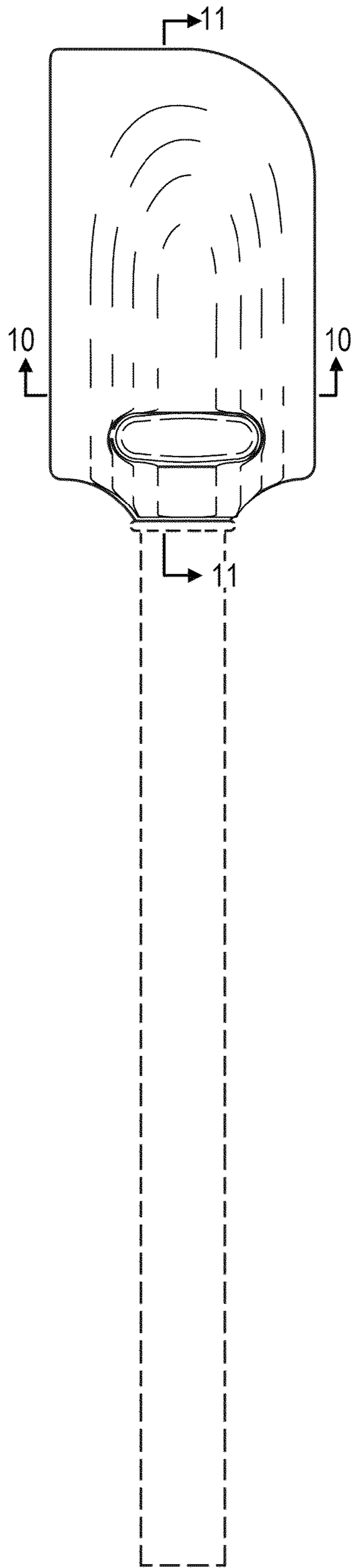

Fig. 2

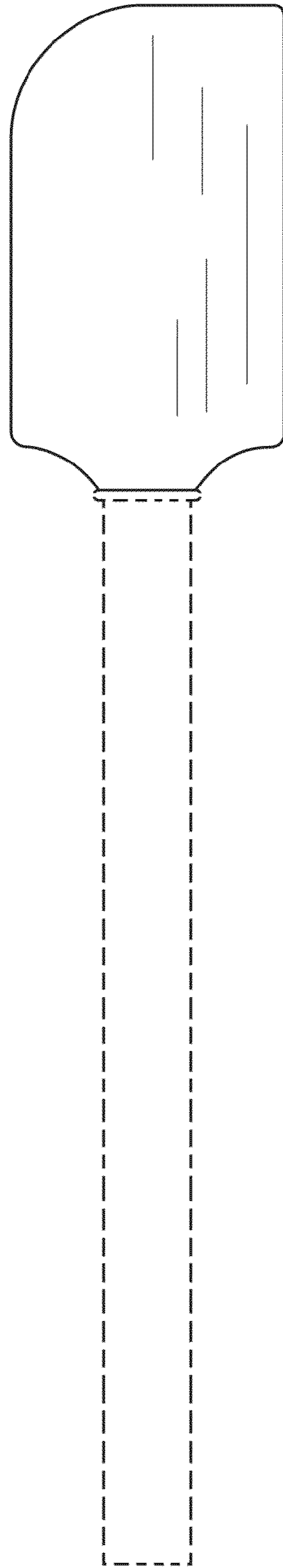

Fig. 3

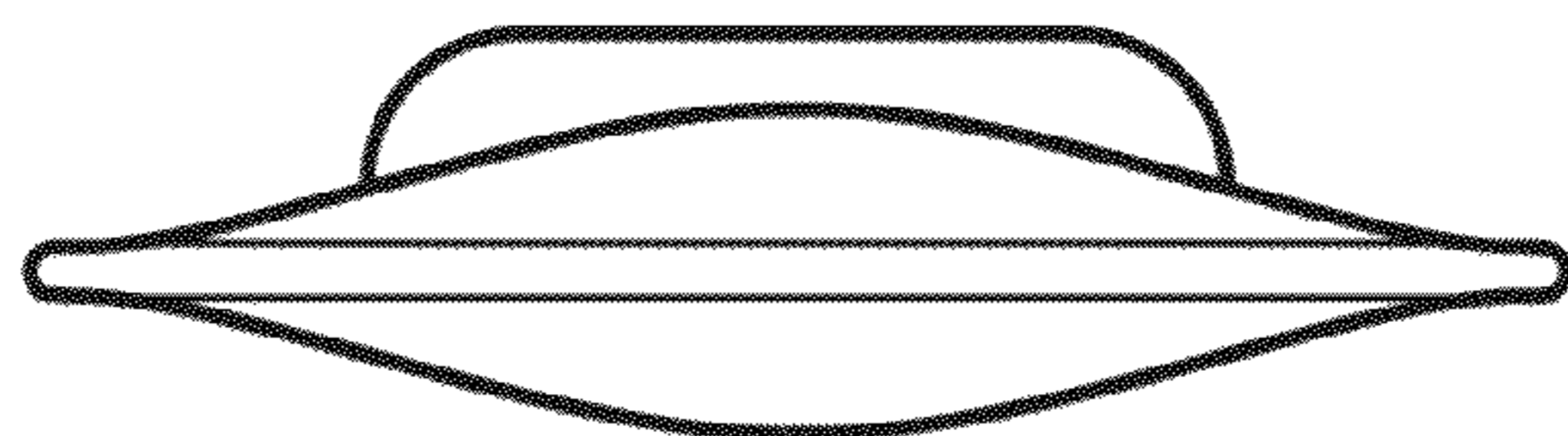

Fig. 4

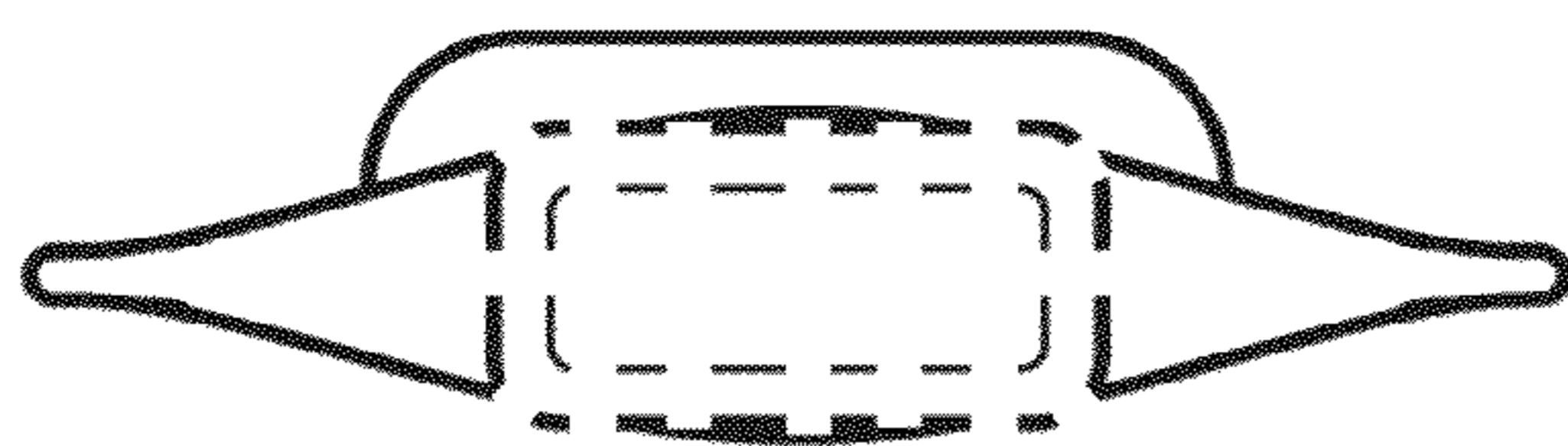

Fig. 5

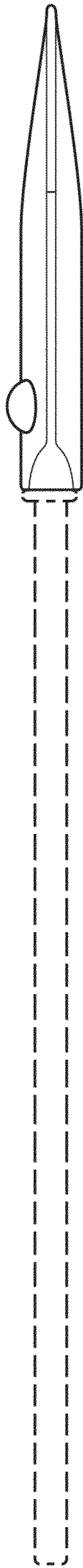

Fig. 6

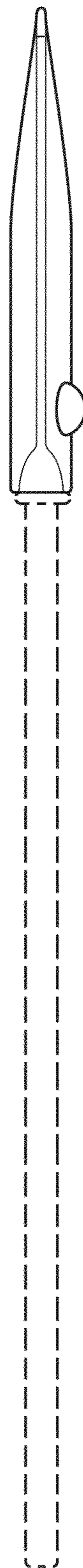

Fig. 7

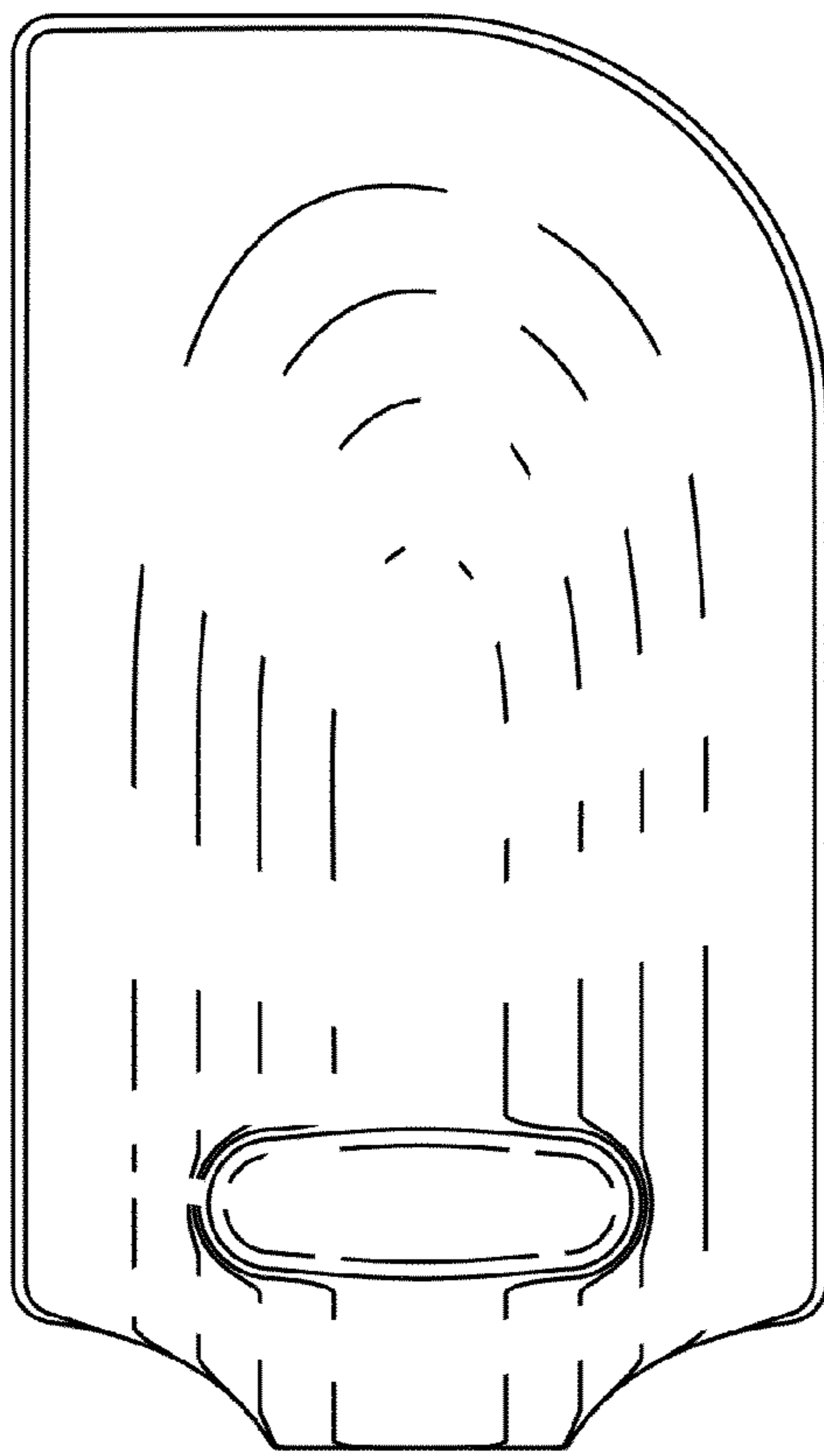

Fig. 8

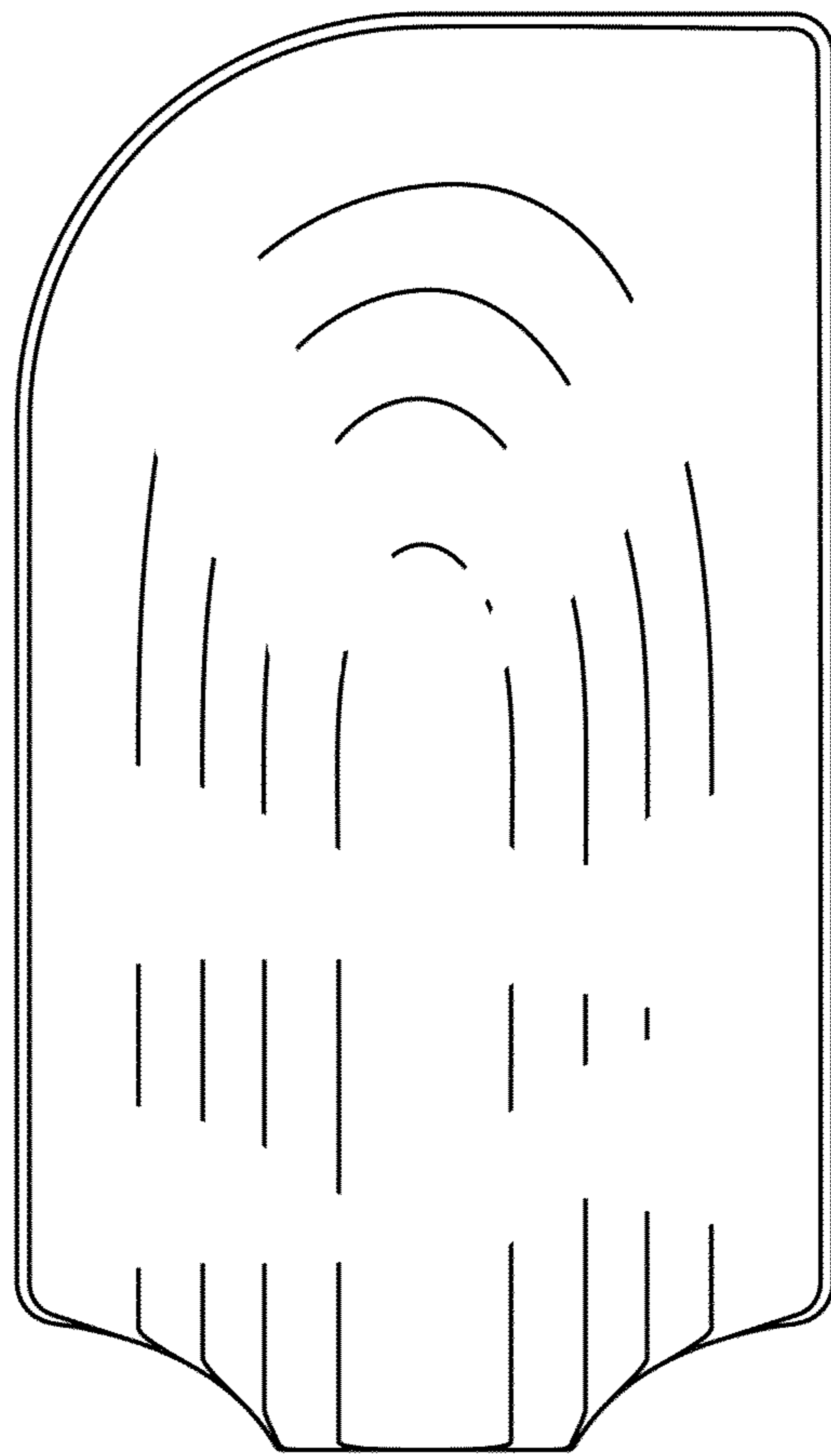

Fig. 9

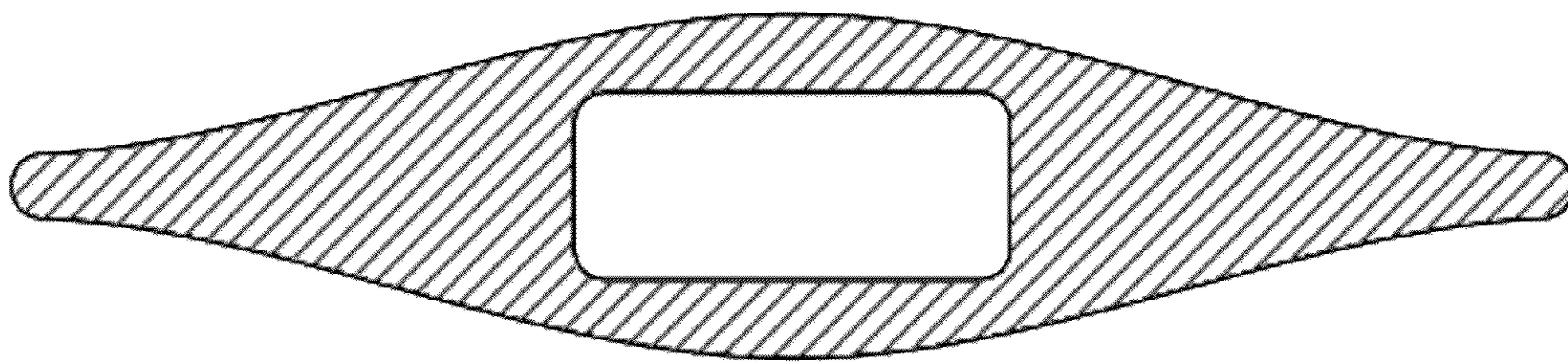

Fig. 10

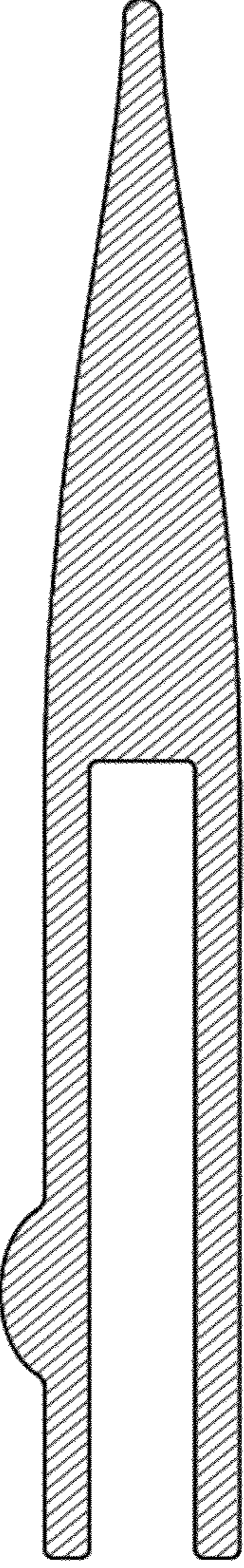

Fig. 11

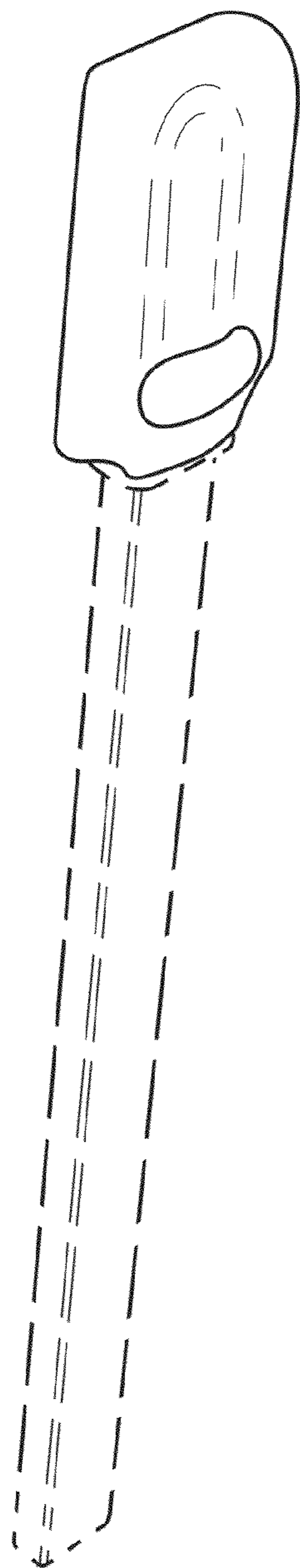

Fig. 12

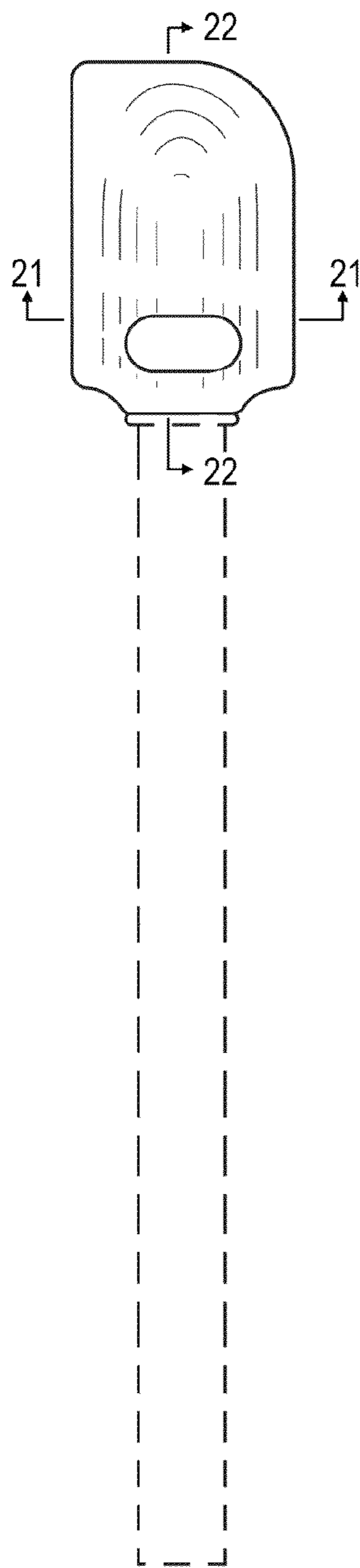

Fig. 13

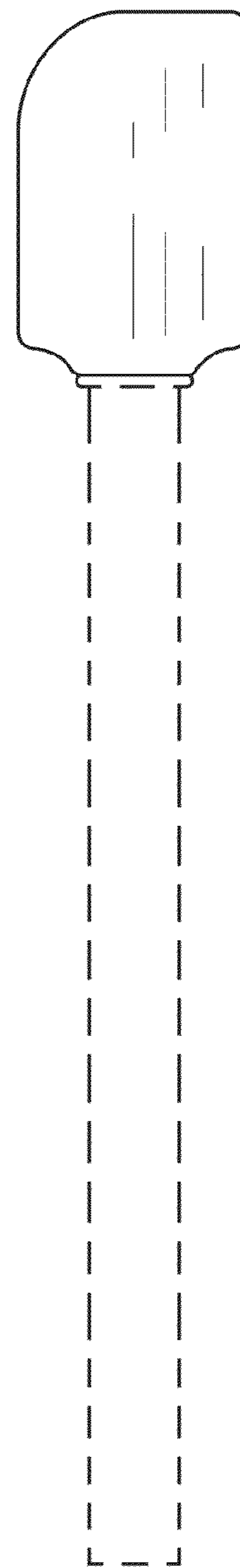

Fig 14

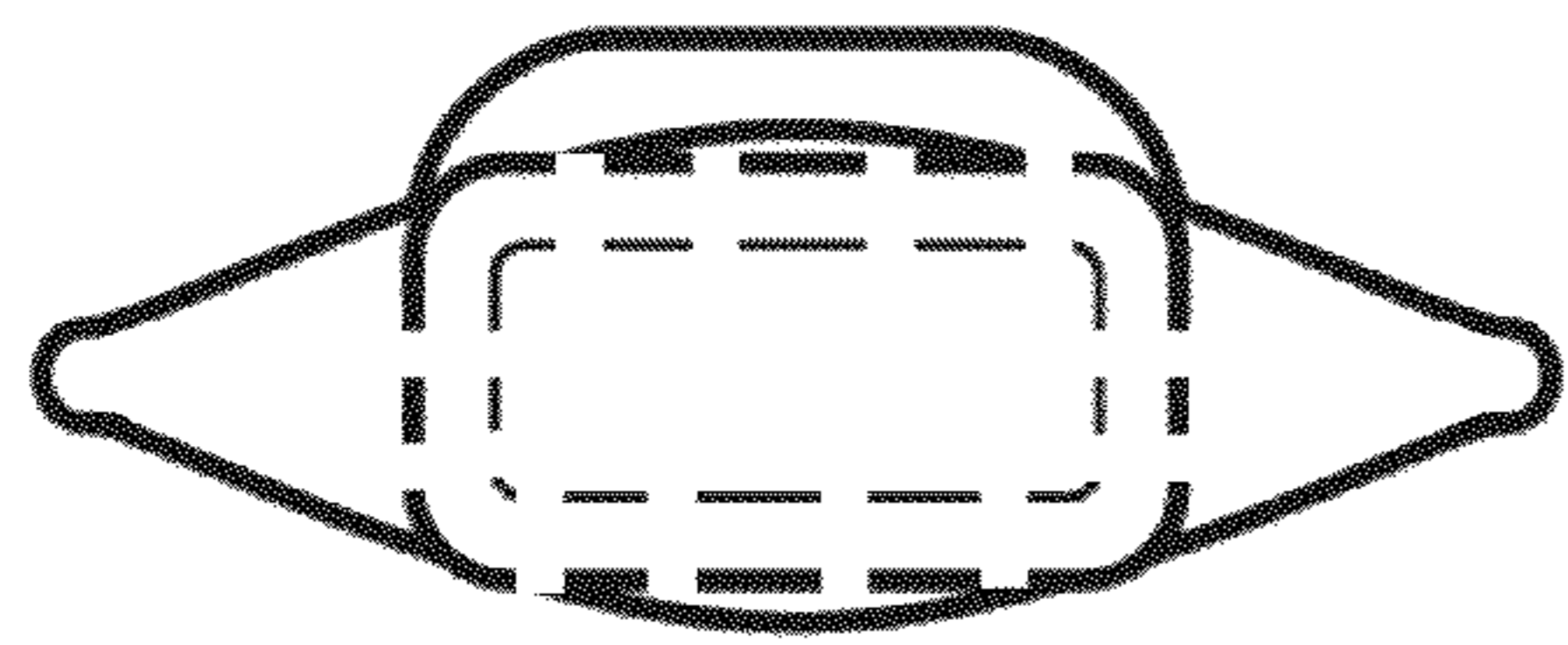

Fig. 16

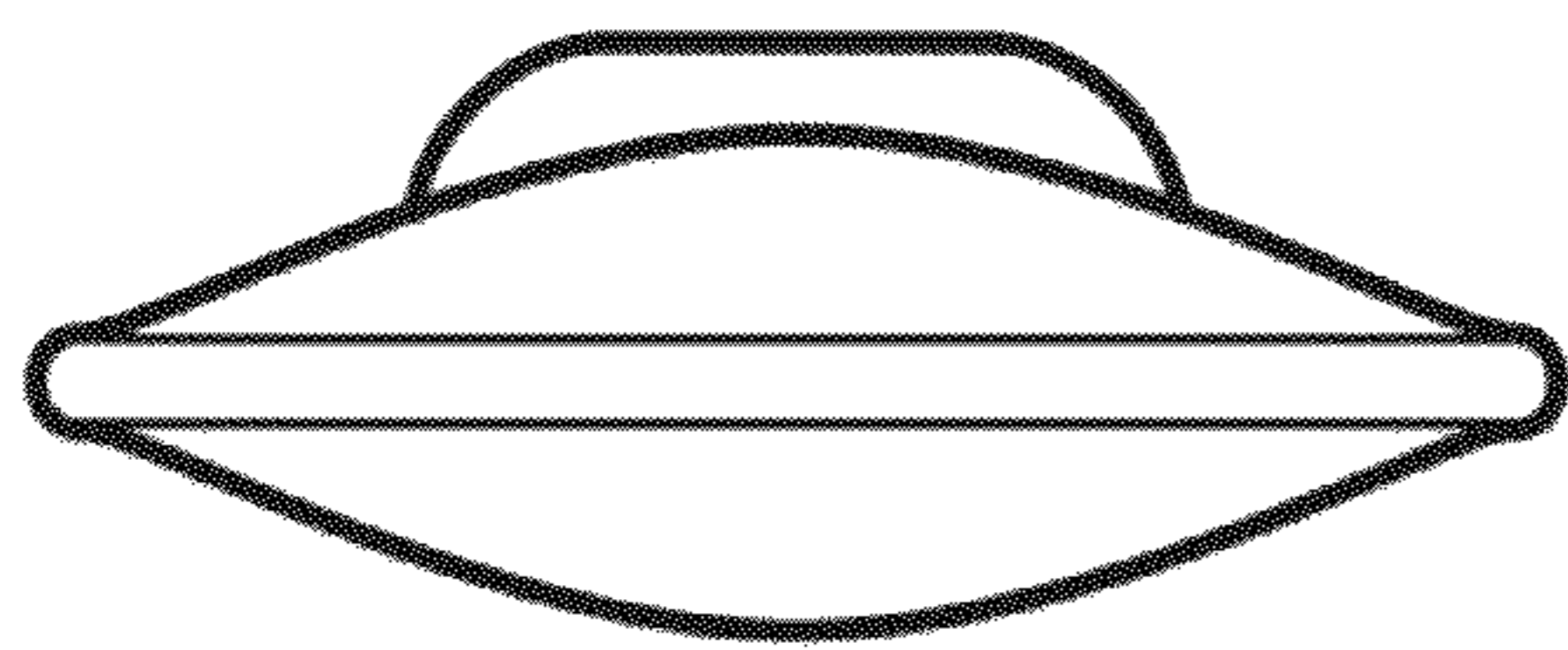

Fig. 15

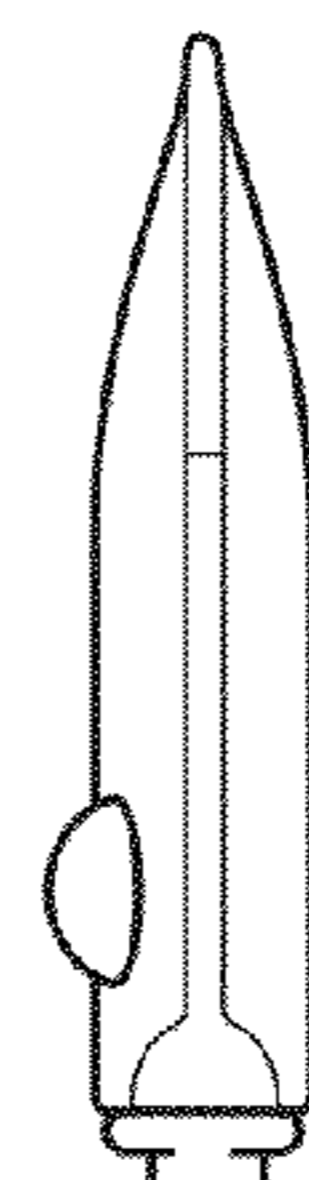

Fig. 17

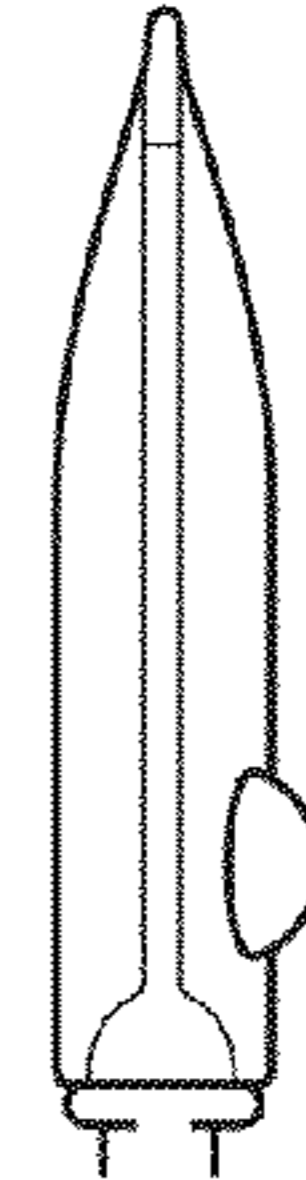

Fig. 18

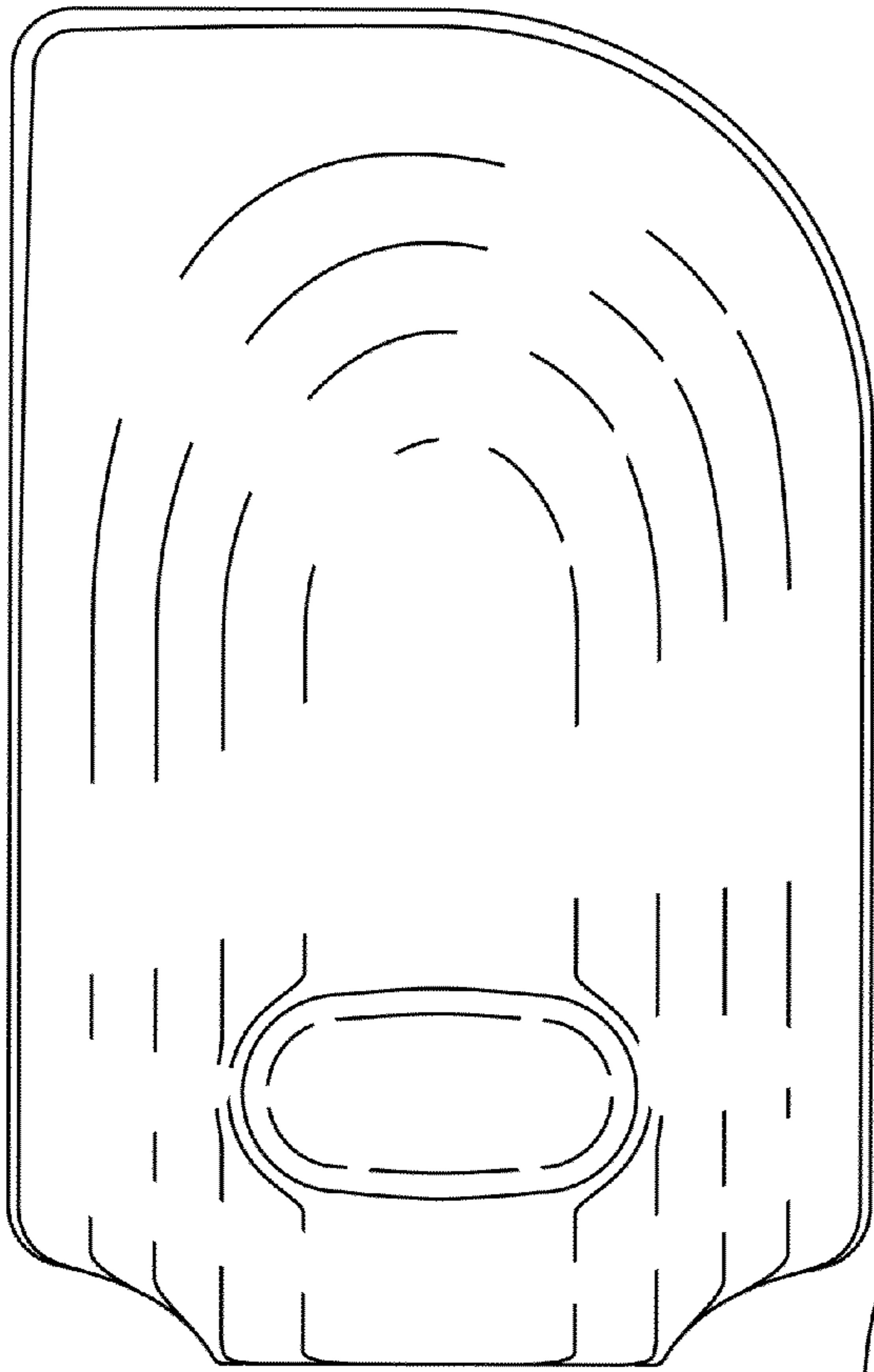

Fig. 19

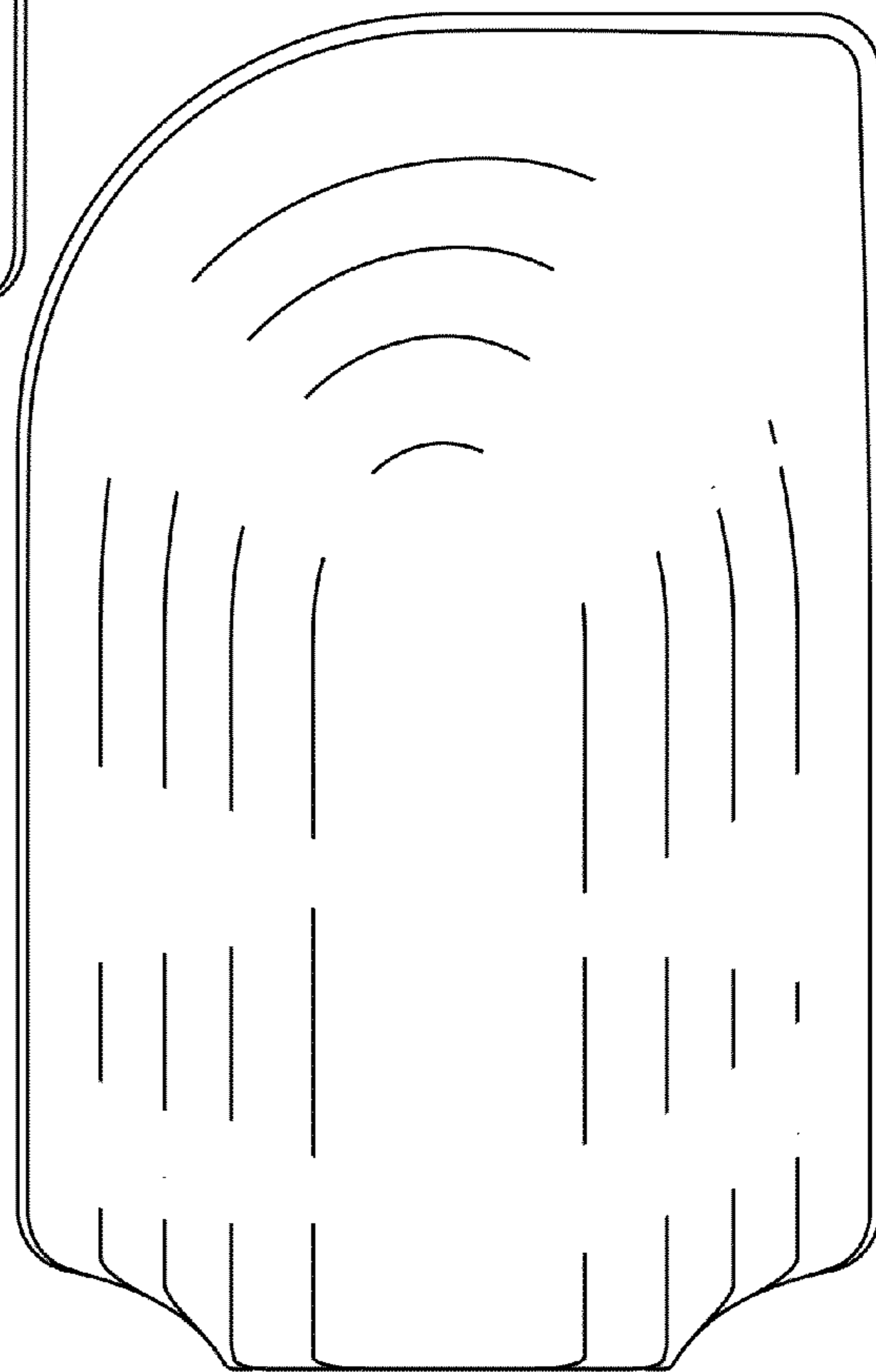

Fig. 20

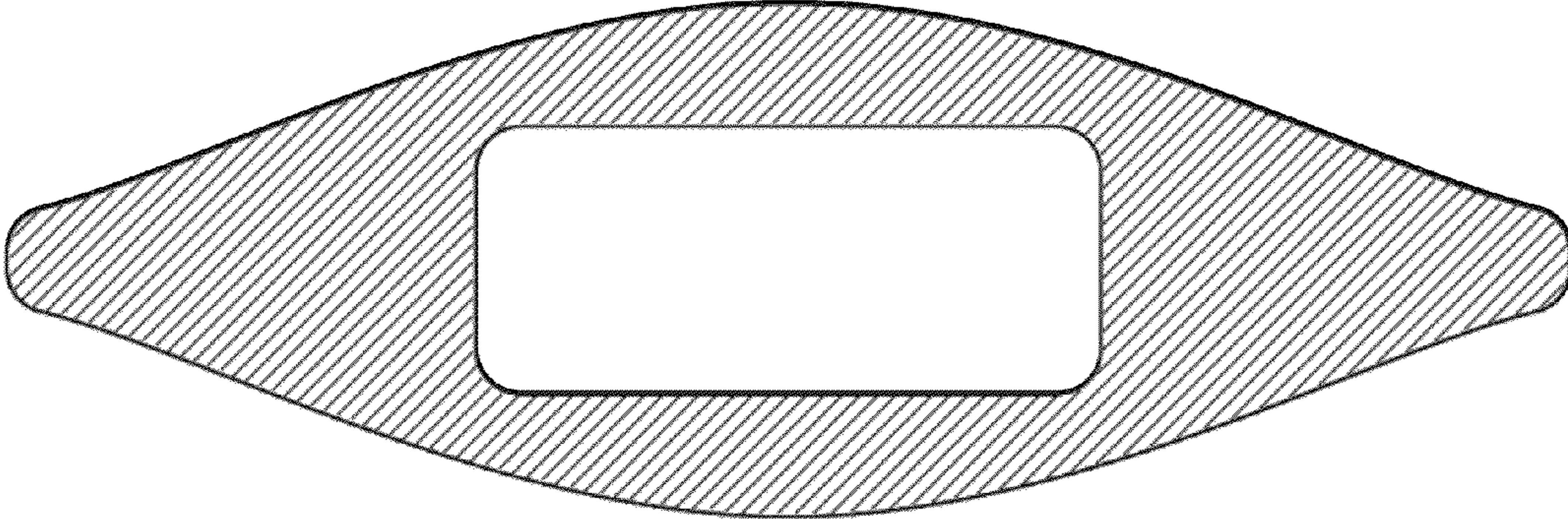

Fig. 21

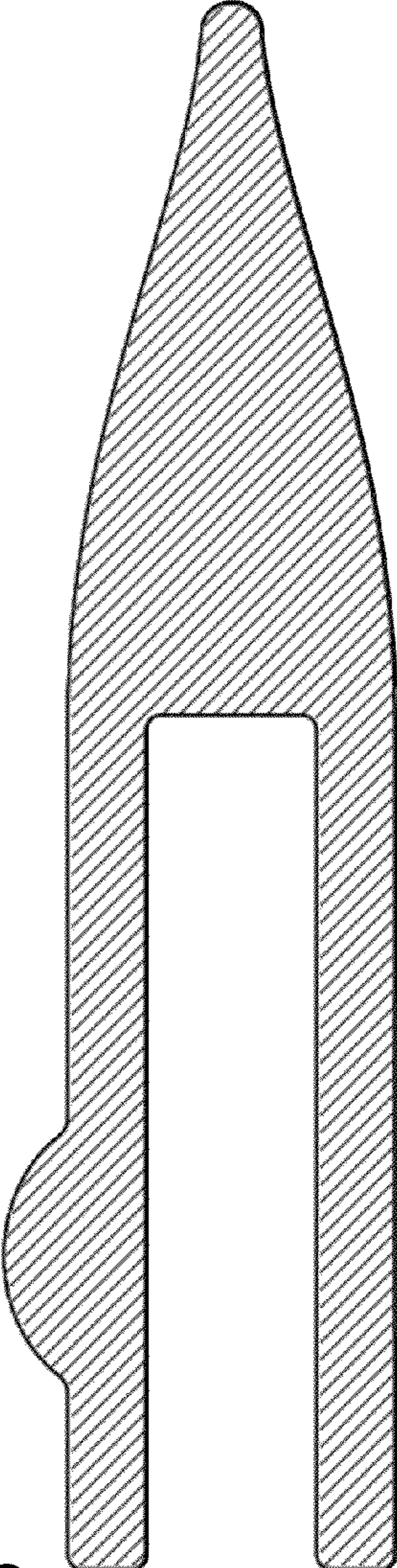

Fig. 22