



US00D713216S

(12) **United States Design Patent**
Hui et al.

(10) **Patent No.:** **US D713,216 S**
(45) **Date of Patent:** **** Sep. 16, 2014**

(54) **FILTER**
(71) Applicant: **Sensio Inc.**, Montréal (CA)
(72) Inventors: **Zhou Hui**, Zhuhai (CN); **Wai Wang**, Foshan (CN); **Ding Li Guo**, Foshan (CN)
(**) Term: **14 Years**
(21) Appl. No.: **29/438,981**
(22) Filed: **Dec. 5, 2012**
(51) **LOC (10) Cl.** **31-00**
(52) **U.S. Cl.**
USPC **D7/655**
(58) **Field of Classification Search**
USPC D7/665-667, 412, 372-374; 241/92, 241/100, 282.1, 101.1-101.7, 285.1-285.3; 99/501-513, 495, 499, 348, 357, 349, 99/369, 370; 366/98, 142, 197-211, 366/241-254, 279-292, 341-347; 100/213, 100/218, 283, 288
See application file for complete search history.

(56) **References Cited**

U.S. PATENT DOCUMENTS

D289,726 S * 5/1987 Greutert D7/400
6,247,393 B1 6/2001 Chang

(Continued)

FOREIGN PATENT DOCUMENTS

CA 2654929 12/2007
EP 0839226 9/2001

(Continued)

Primary Examiner — Terry Wallace

(74) *Attorney, Agent, or Firm* — McDonnell Boehnen Hulbert & Berghoff LLP

(57) **CLAIM**

The ornamental design for a filter, as shown and described.

DESCRIPTION

FIG. 1 is a perspective view taken from a top, front of a filter, according to a first embodiment of our new design;

FIG. 2 is a front elevation view thereof;
FIG. 3 is a rear elevation view thereof;
FIG. 4 is a left side elevation view thereof;
FIG. 5 is a right side elevation view thereof;
FIG. 6 is a top plan view thereof;
FIG. 7 is a bottom plan view thereof;
FIG. 8 is a perspective view taken from a bottom, front thereof;
FIG. 9 is a cross-sectional view taken along line 9-9 in FIG. 1;
FIG. 10 is a perspective view taken from a top, front of a filter, according to a second embodiment of our new design;
FIG. 11 is a front elevation view thereof;
FIG. 12 is a rear elevation view thereof;
FIG. 13 is a left side elevation view thereof;
FIG. 14 is a right side elevation view thereof;
FIG. 15 is a top plan view thereof;
FIG. 16 is a bottom plan view thereof;
FIG. 17 is a perspective view taken from a bottom, front thereof;
FIG. 18 is a cross-sectional view taken along line 18-18 in FIG. 10;
FIG. 19 is a perspective view taken from a top, front of a filter, according to a third embodiment of our new design;
FIG. 20 is a front elevation view thereof;
FIG. 21 is a rear elevation view thereof;
FIG. 22 is a left side elevation view thereof;
FIG. 23 is a right side elevation view thereof;
FIG. 24 is a top plan view thereof;
FIG. 25 is a bottom plan view thereof; and,
FIG. 26 is a perspective view taken from a bottom, front thereof.
The design consists of the visual features of the portions of the filter shown in solid lines in the drawings, whether those features are features of one of shape, configuration, ornament or pattern or a combination of any of these features. Throughout the Figures, where shown: (i) the dotted lines showing additional structure of the filter are for illustrative purposes only and form no part of the claimed design; (ii) the unshaded and dotted surfaces do not form part of the claimed design. Portions of the filter not shown in the Figures and not otherwise described in this Specification do not form part of the claimed design.

1 Claim, 26 Drawing Sheets

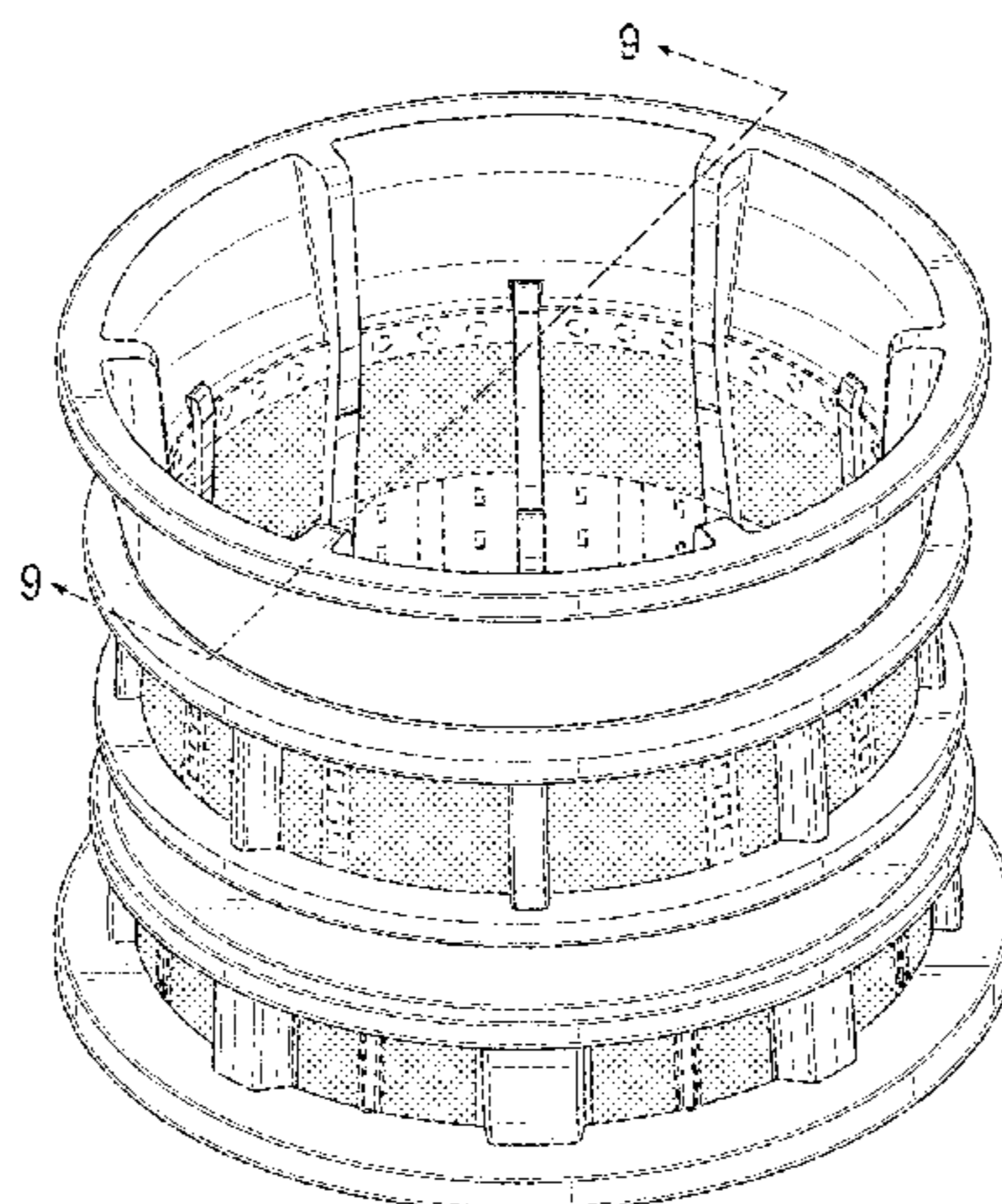

(56)

References Cited

U.S. PATENT DOCUMENTS

D449,873 S *	10/2001	Bronson	D23/261
D643,265 S	8/2011	Kim et al.		
8,091,473 B2	1/2012	Kim		
2011/0083566 A1	4/2011	Backus		

FOREIGN PATENT DOCUMENTS

EP	1639905	3/2006
EP	1689250	8/2006
EP	1066953	12/2006
EP	1619966	12/2006
EP	1903094	3/2010
EP	2194822	6/2010
EP	2194823	6/2010
EP	2334217	6/2011
EP	1692954	8/2011
EP	2352404	8/2011
EP	2427088	3/2012
EP	2326220	8/2012
EP	2497393	9/2012
EP	2510842	10/2012

EP	2515721	10/2012
EP	2545818	1/2013
ES	2217926	11/2004
ES	2238110	8/2005
FR	2839255	11/2003
FR	2906110	3/2008
FR	2932665	12/2009
FR	2938415	5/2010
FR	2939355	6/2010
FR	2945196	11/2010
FR	2954072	6/2011
FR	2967034	5/2012
FR	2967035	5/2012
WO	2012/007406	1/2012
WO	2012/013150	2/2012
WO	2012/036381	3/2012
WO	2012/057483	5/2012
WO	2012/057484	5/2012
WO	2012/091235	7/2012
WO	2012/108588	8/2012
WO	2012/121642	9/2012
WO	2012/165713	12/2012
WO	2013/012198	1/2013

* cited by examiner

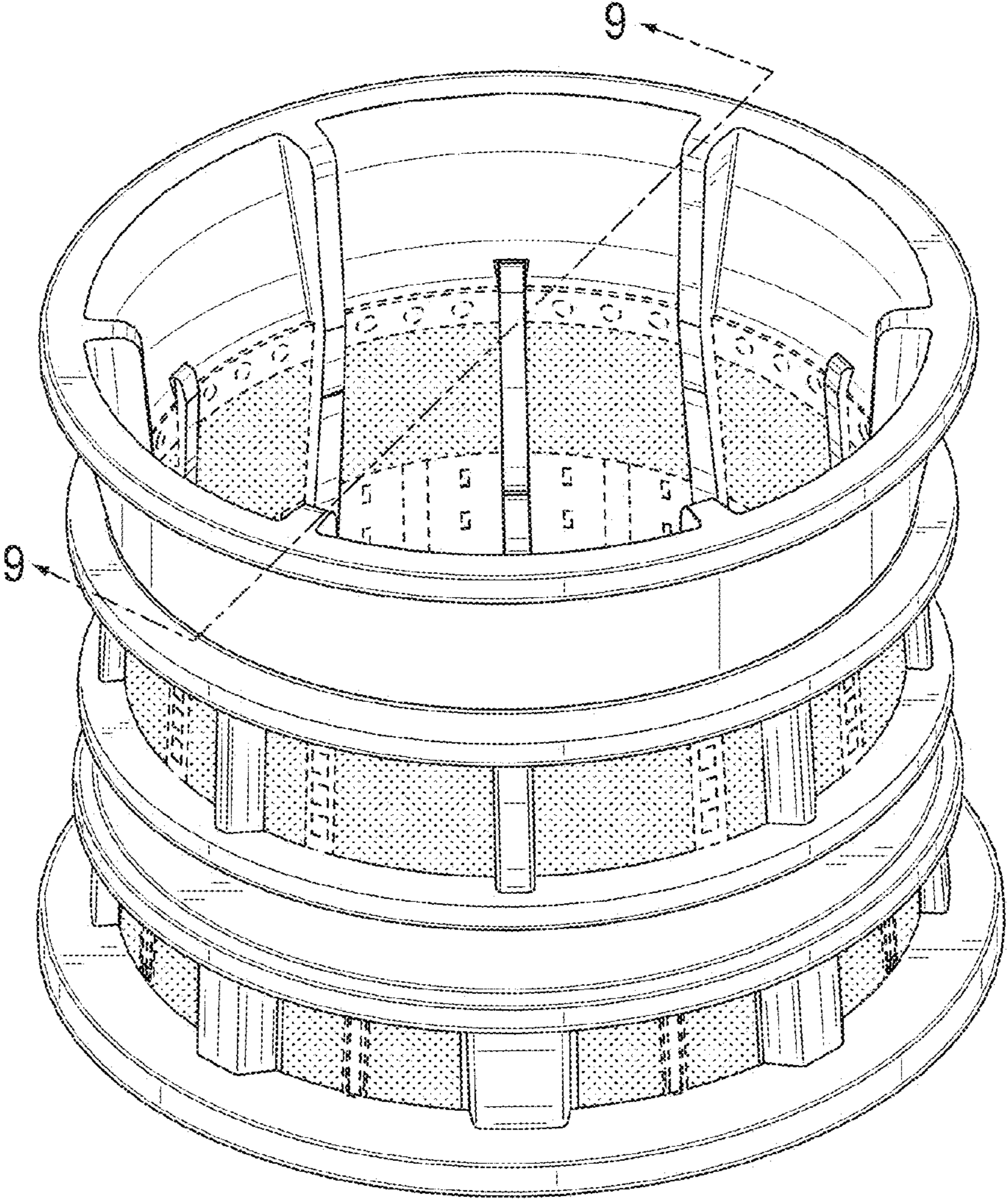

FIG. 1

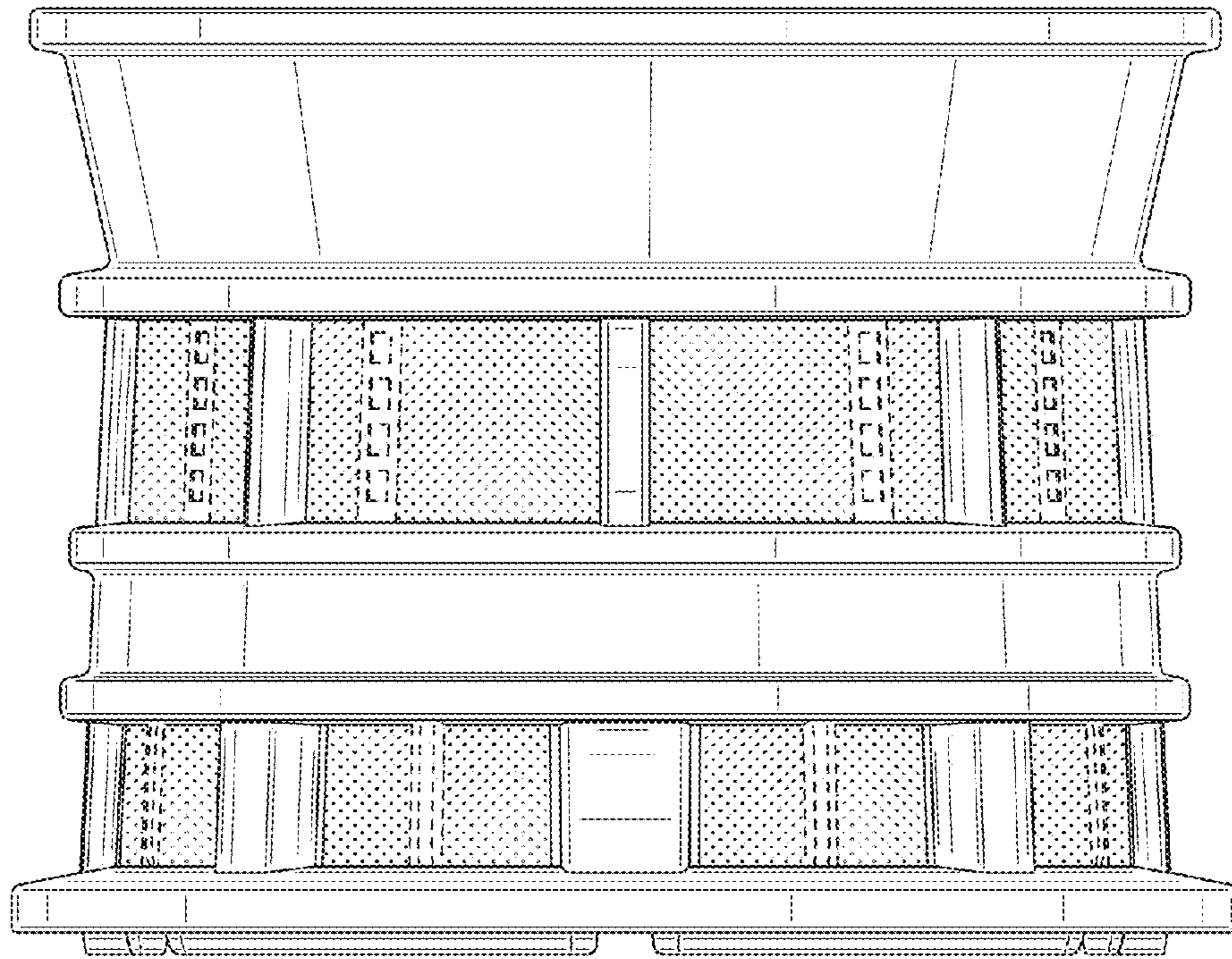

FIG. 2

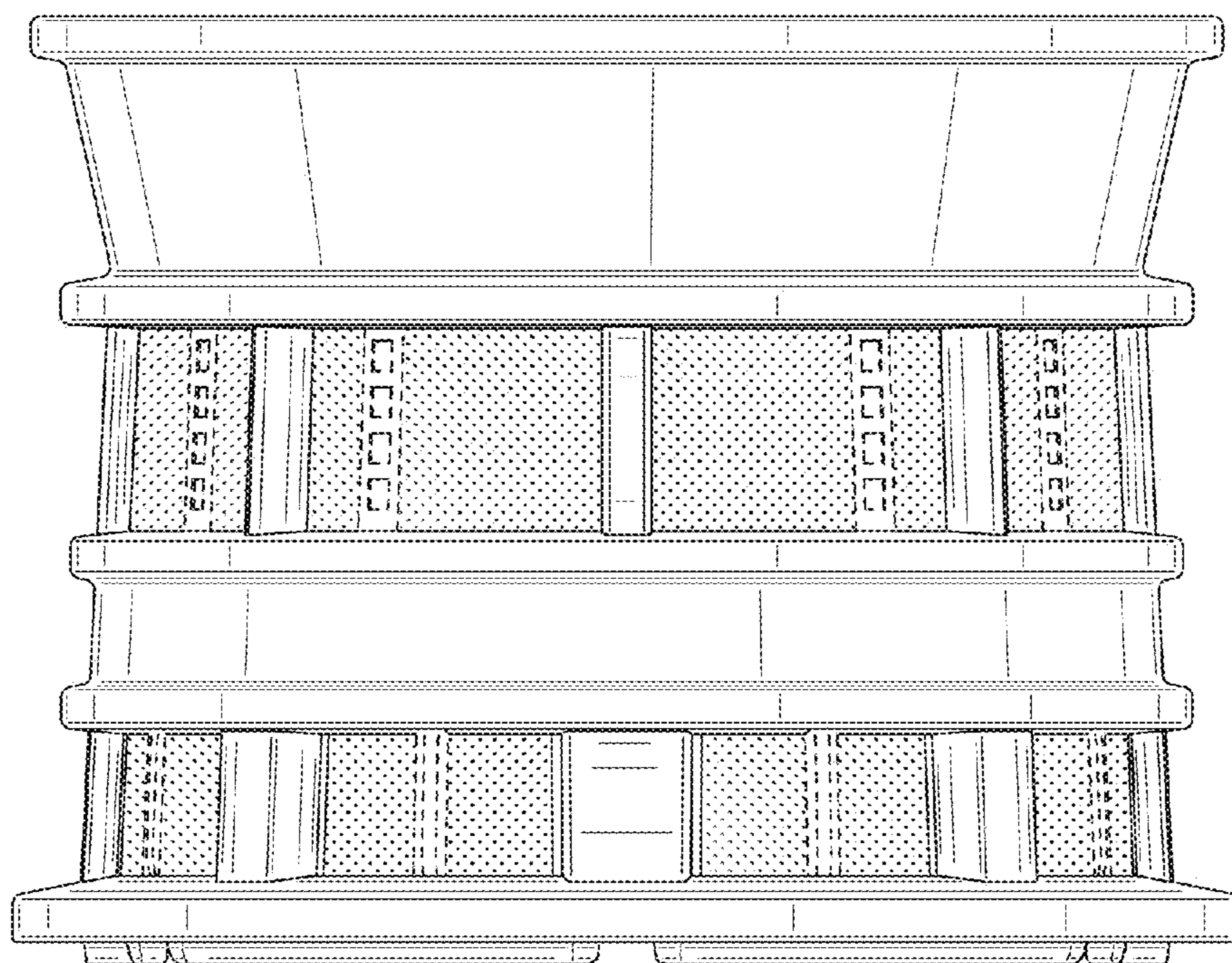

FIG. 3

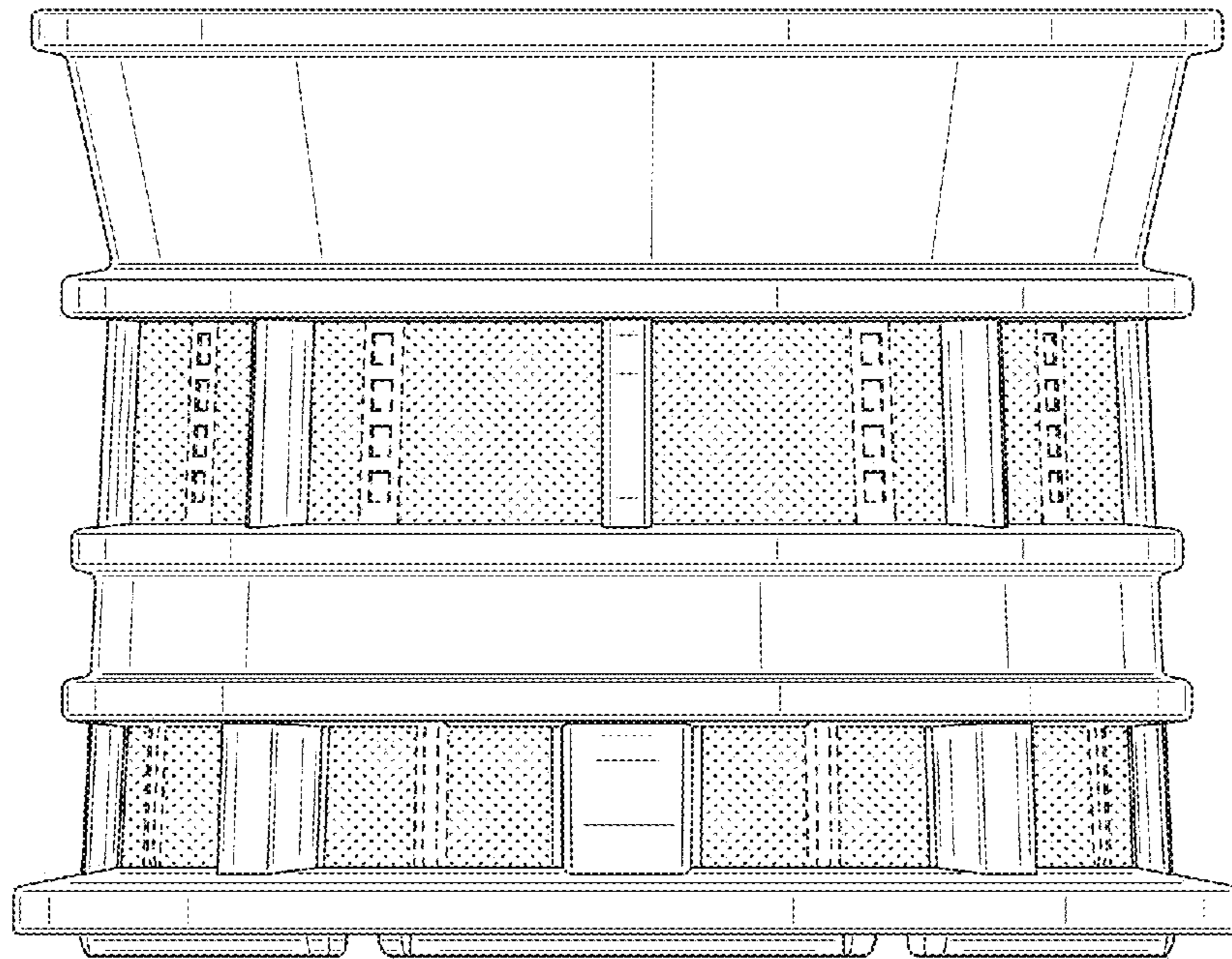

FIG. 4

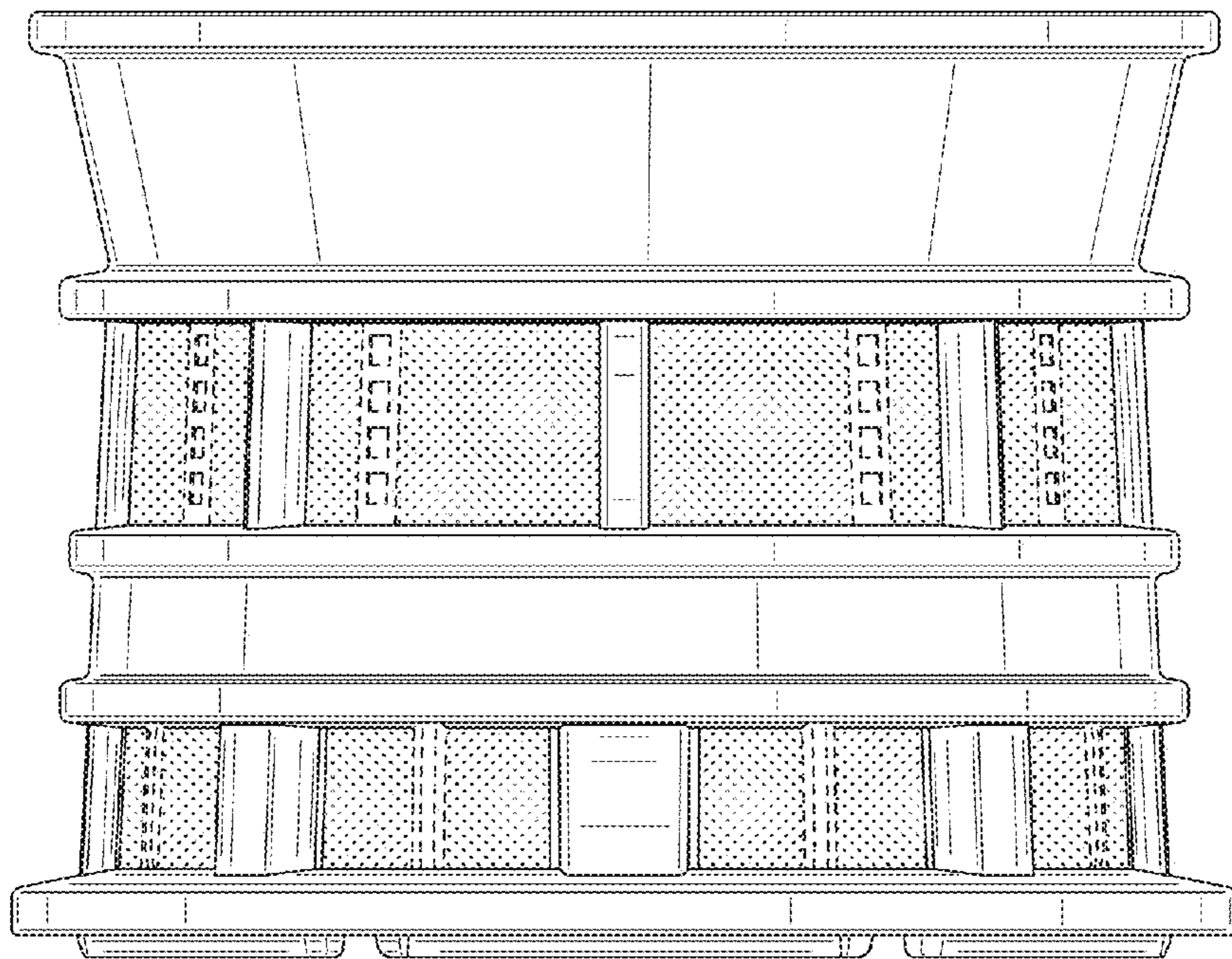

FIG. 5

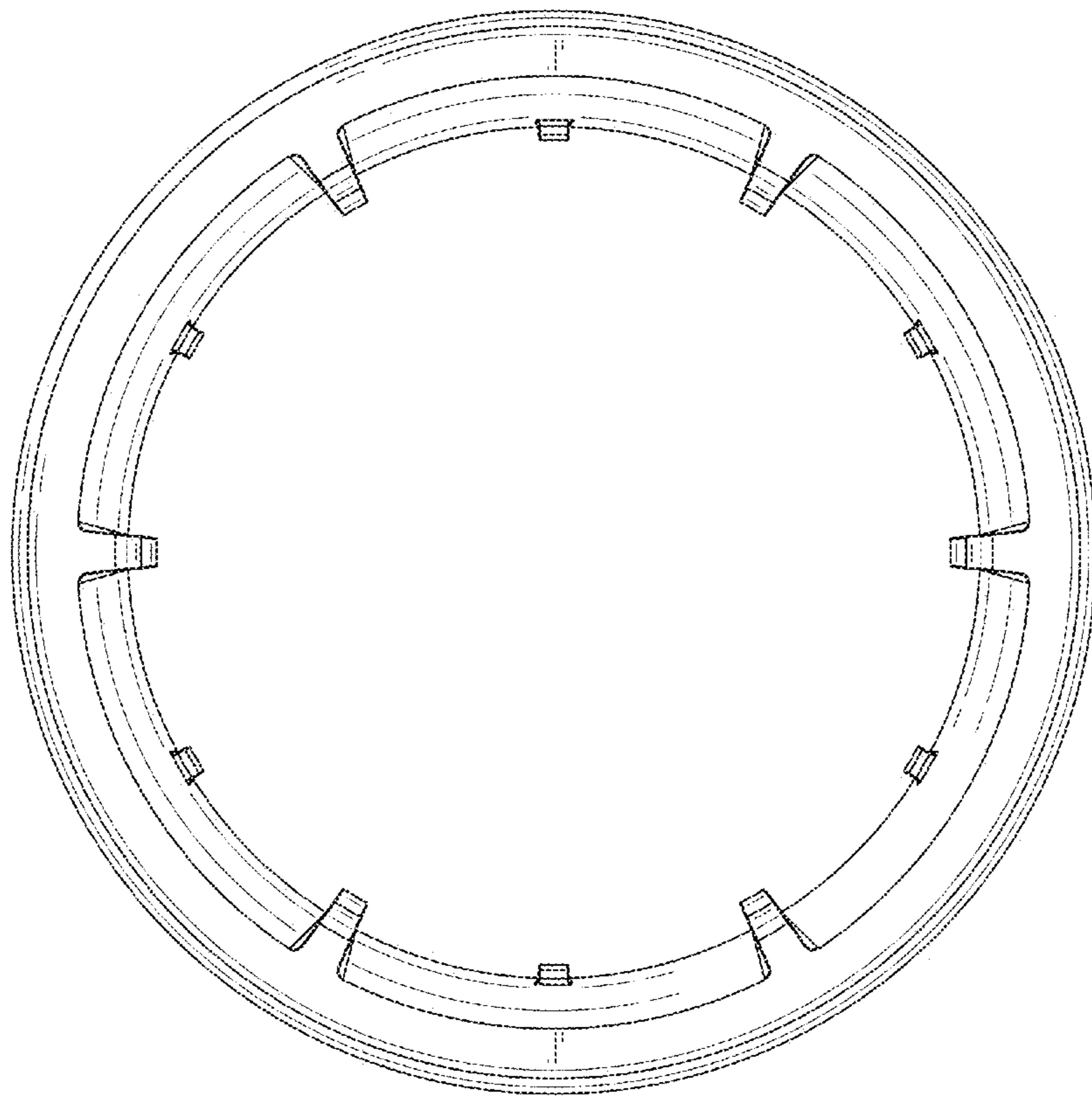

FIG. 6

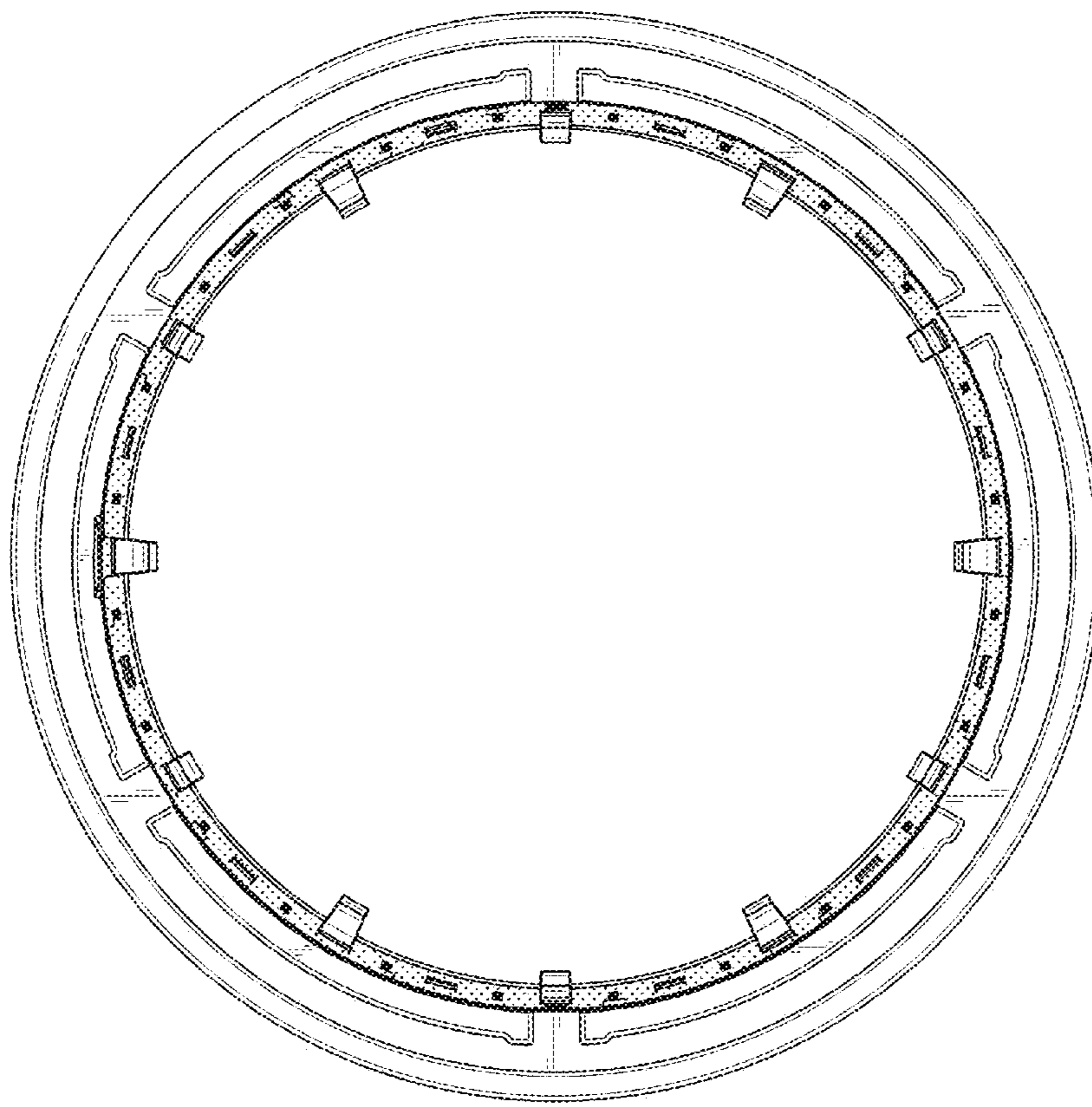

FIG. 7

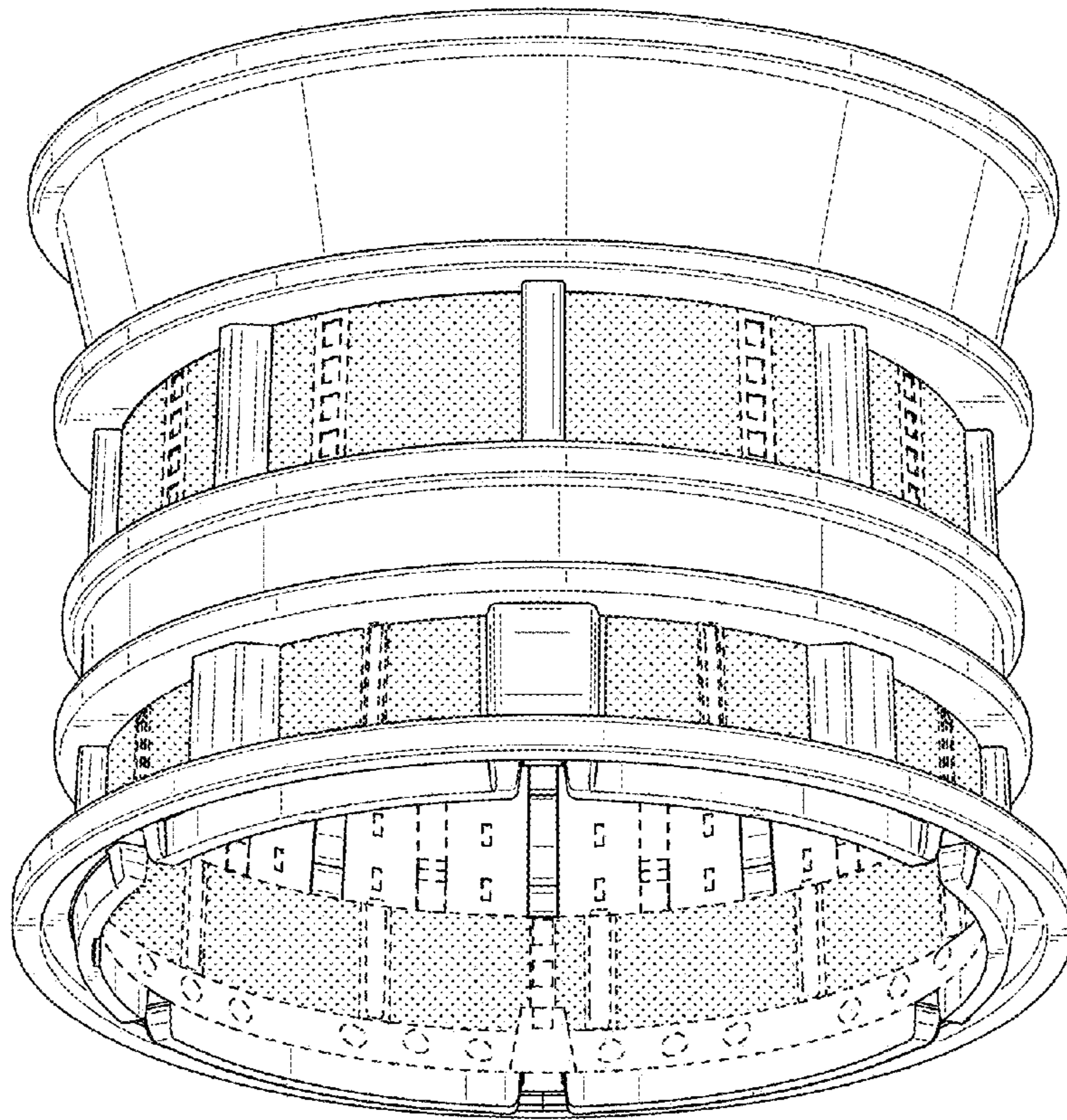

FIG. 8

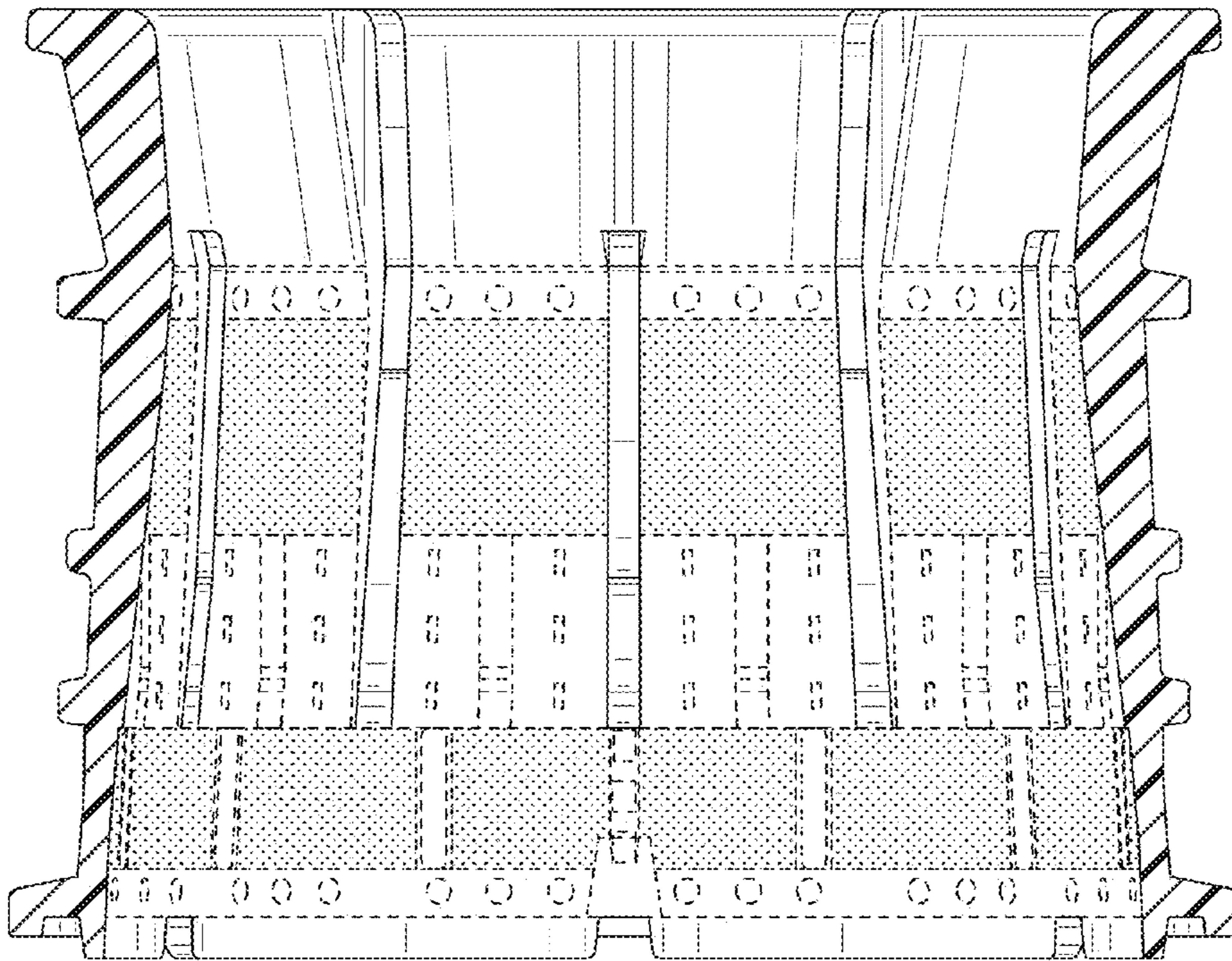

FIG. 9

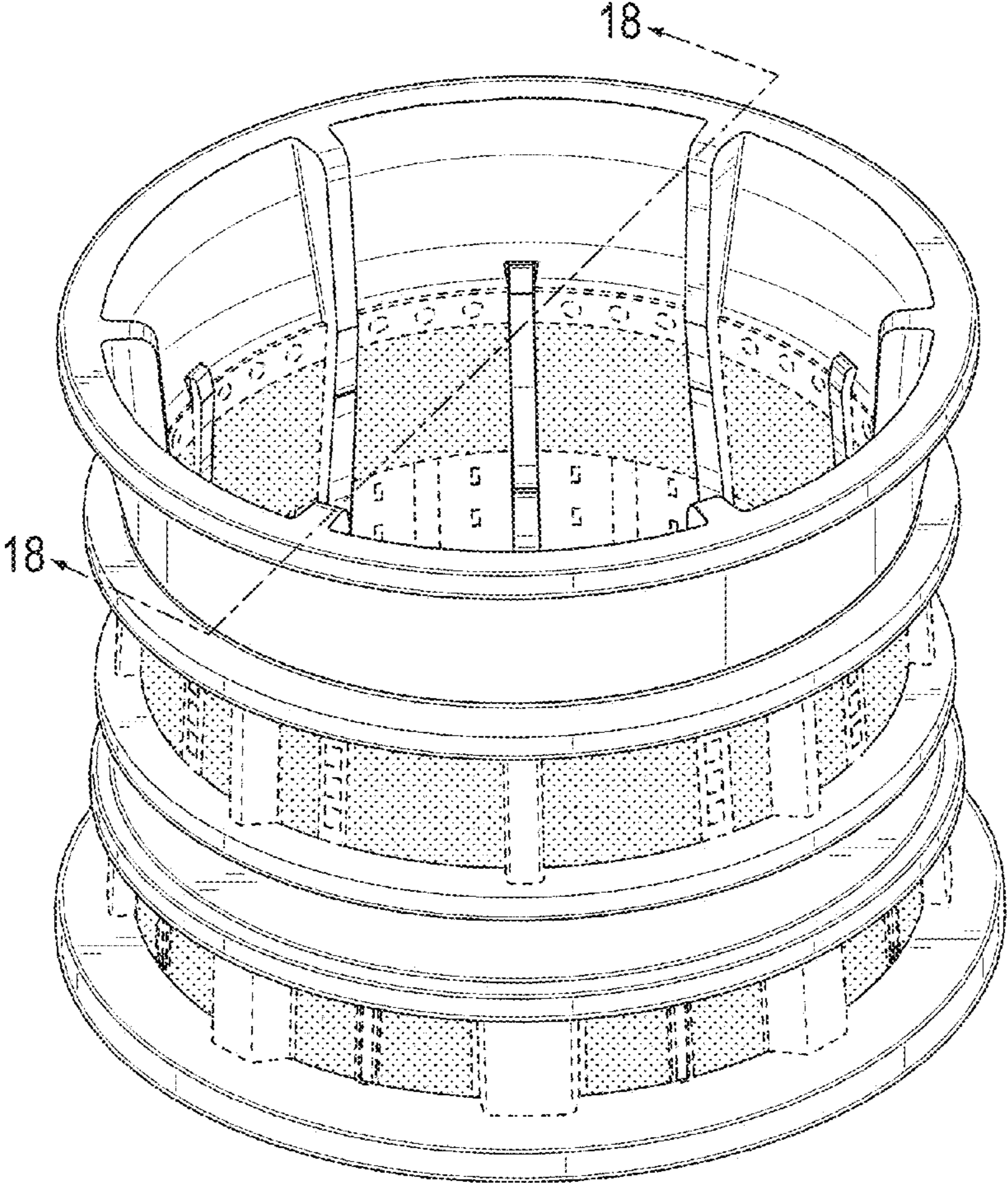

FIG. 10

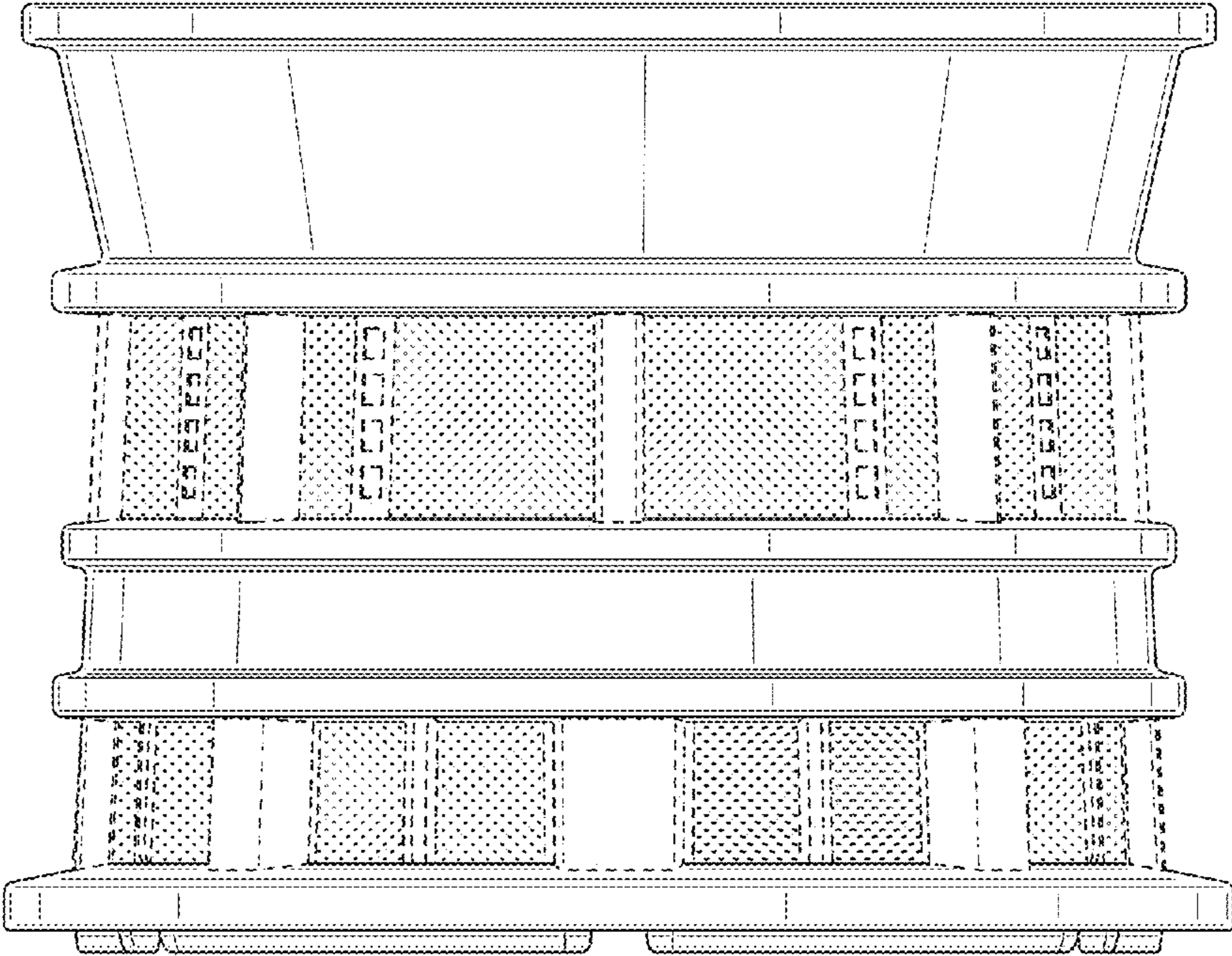

FIG. 11

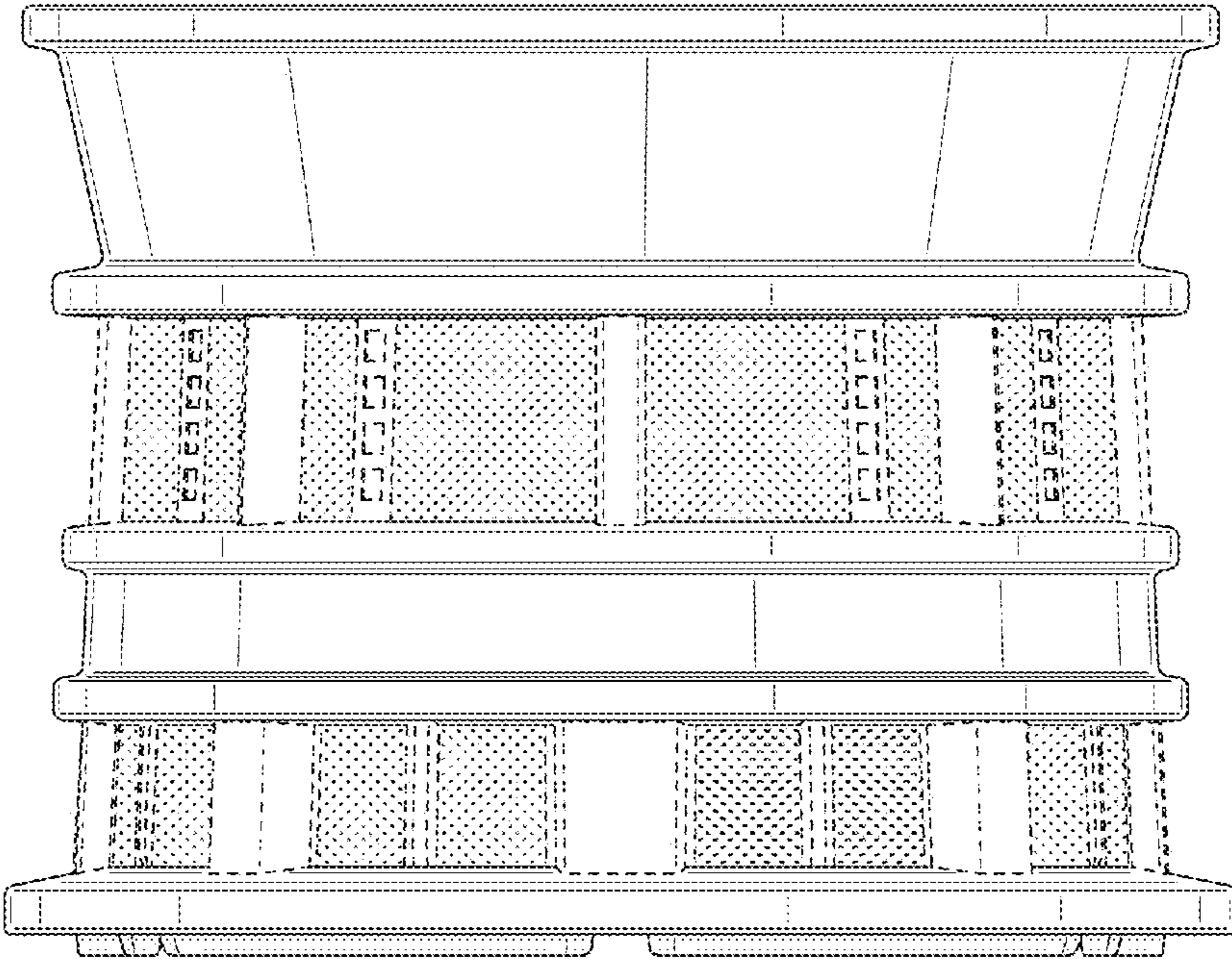

FIG. 12

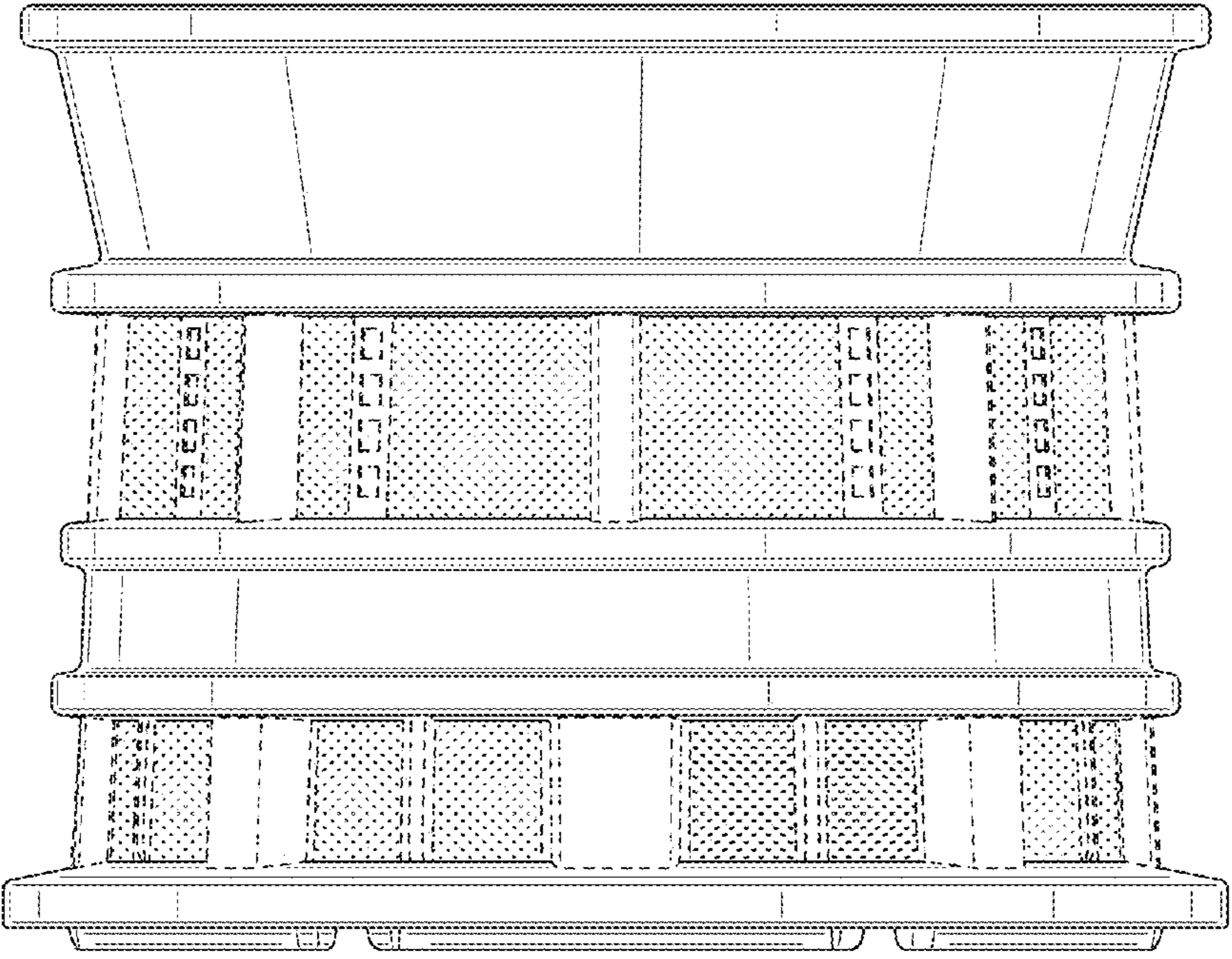

FIG. 13

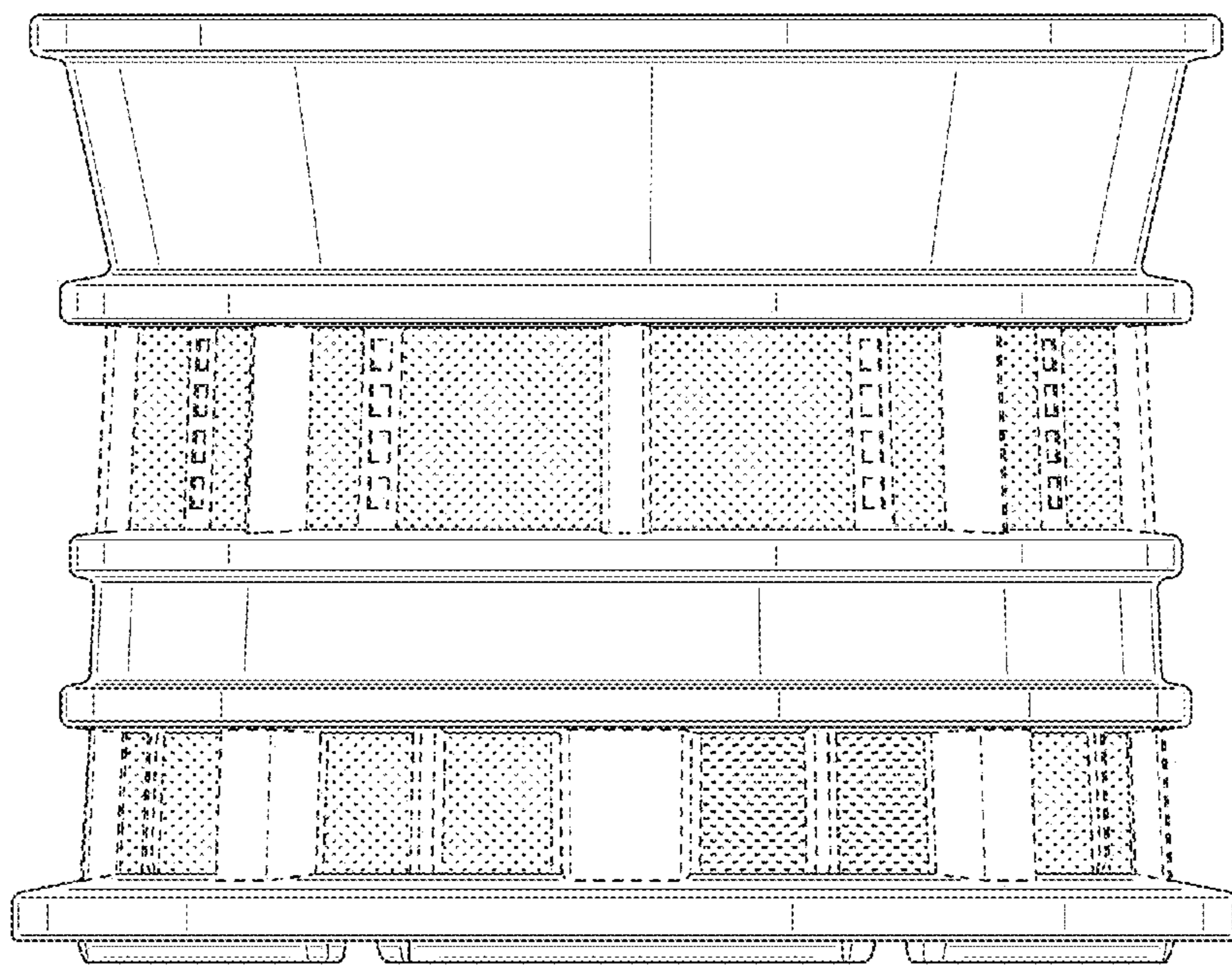

FIG. 14

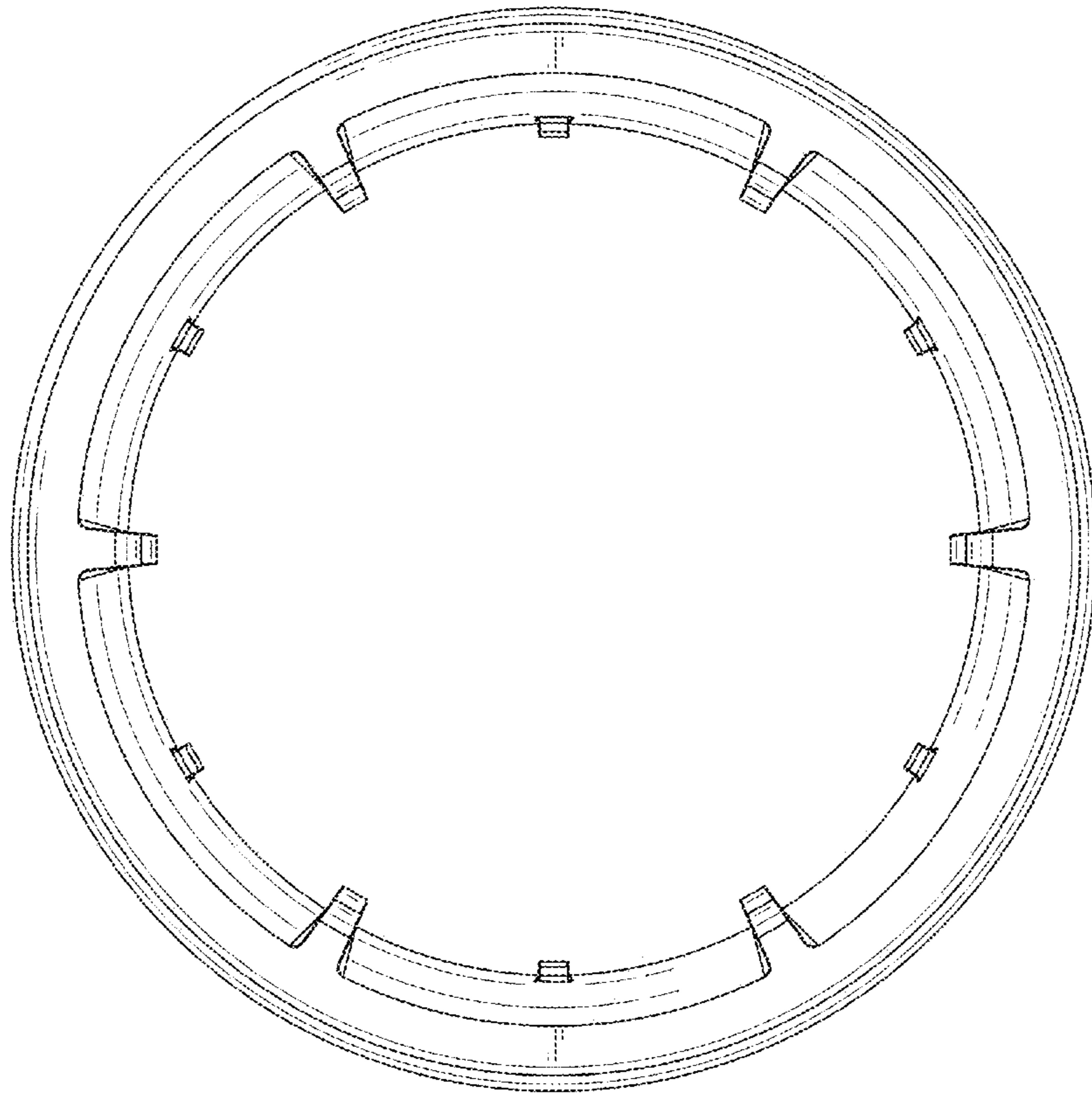

FIG. 15

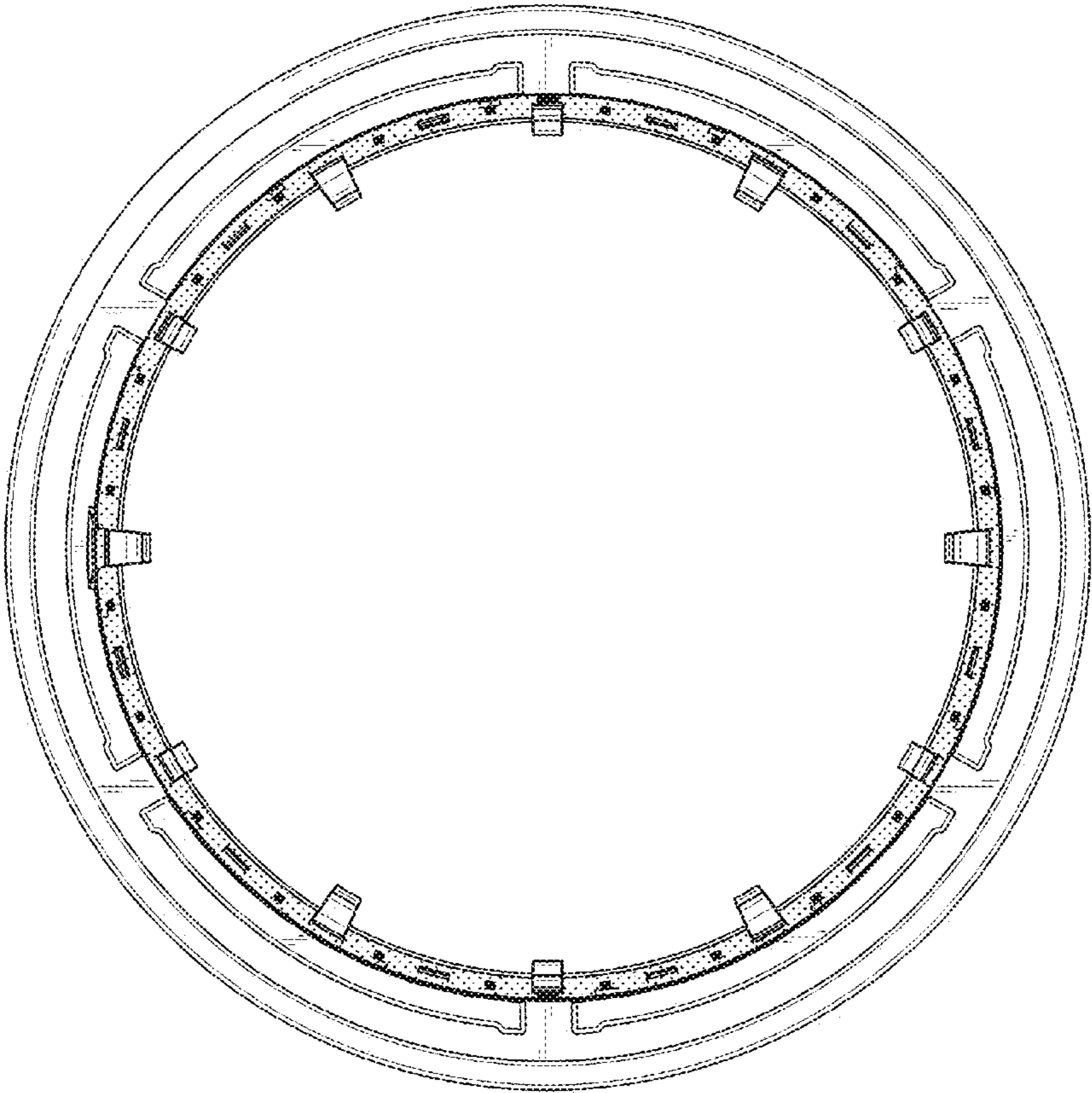

FIG. 16

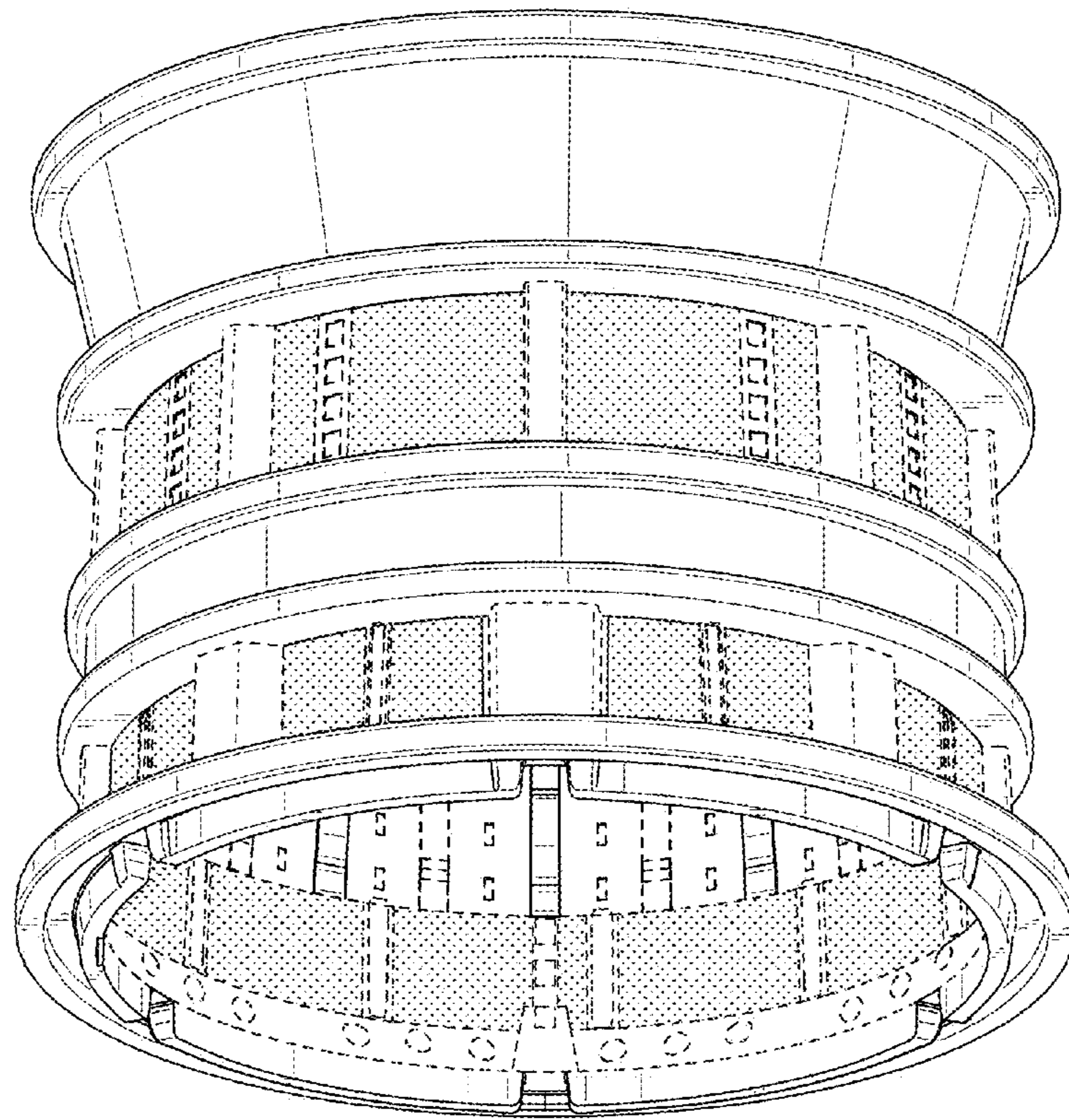

FIG. 17

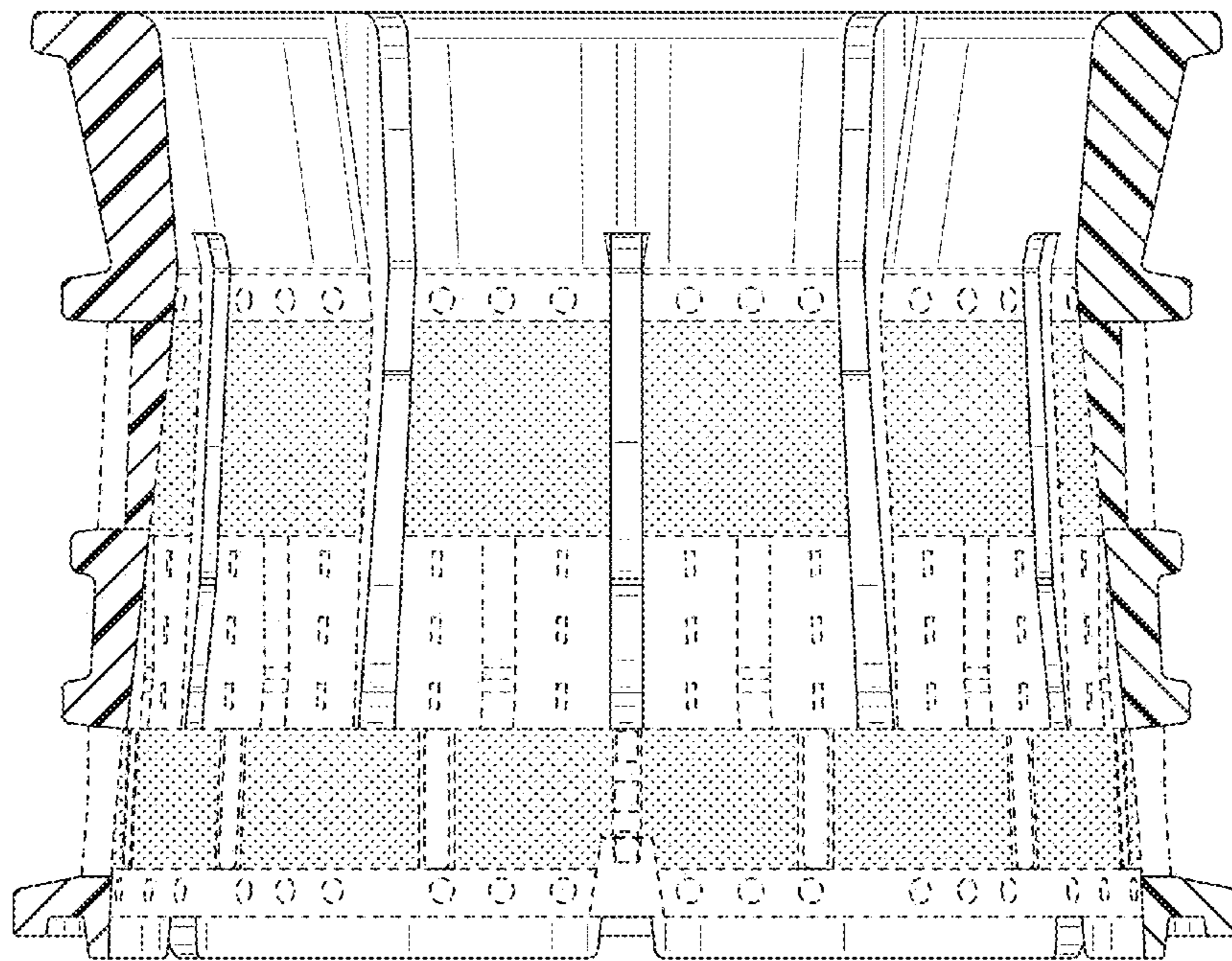

FIG. 18

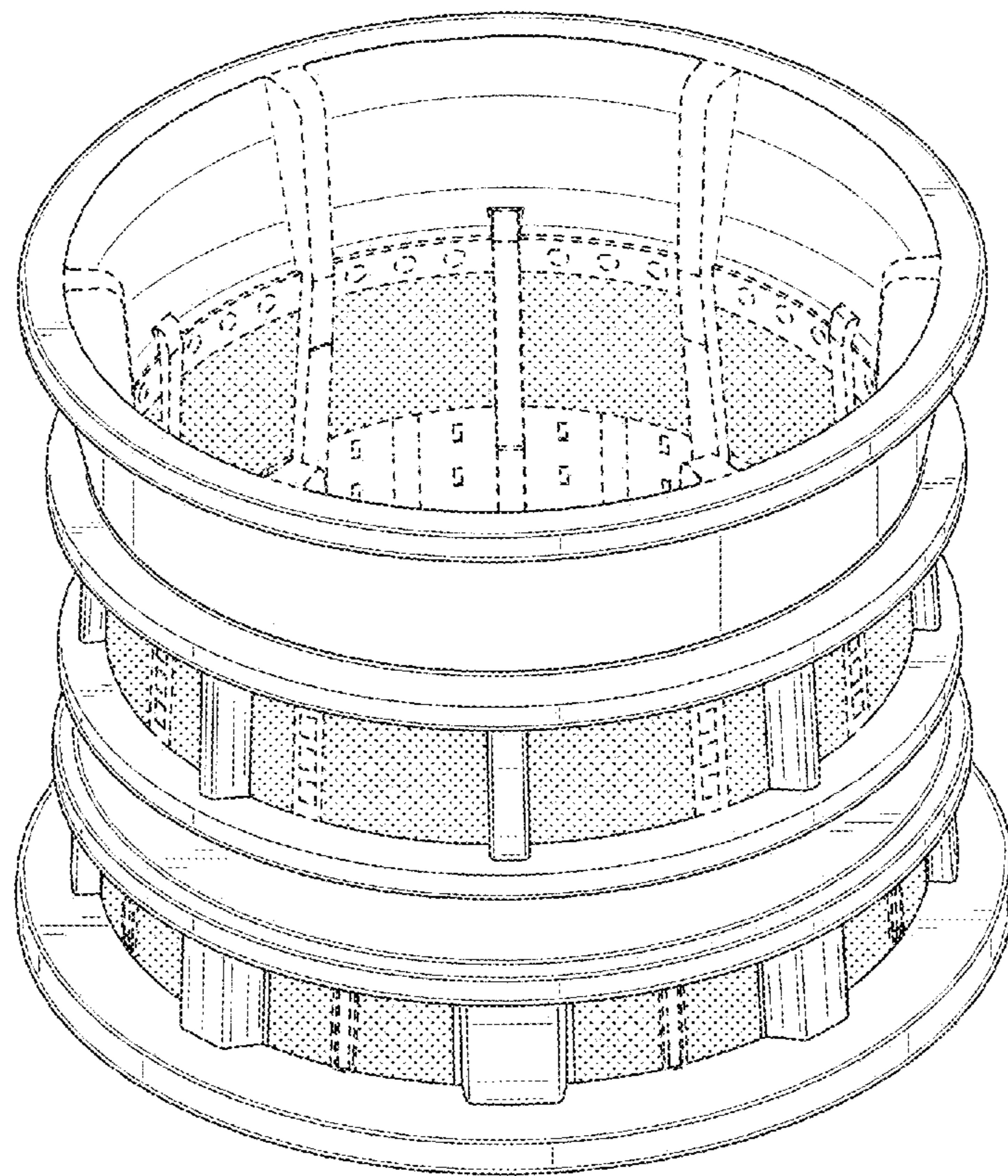

FIG. 19

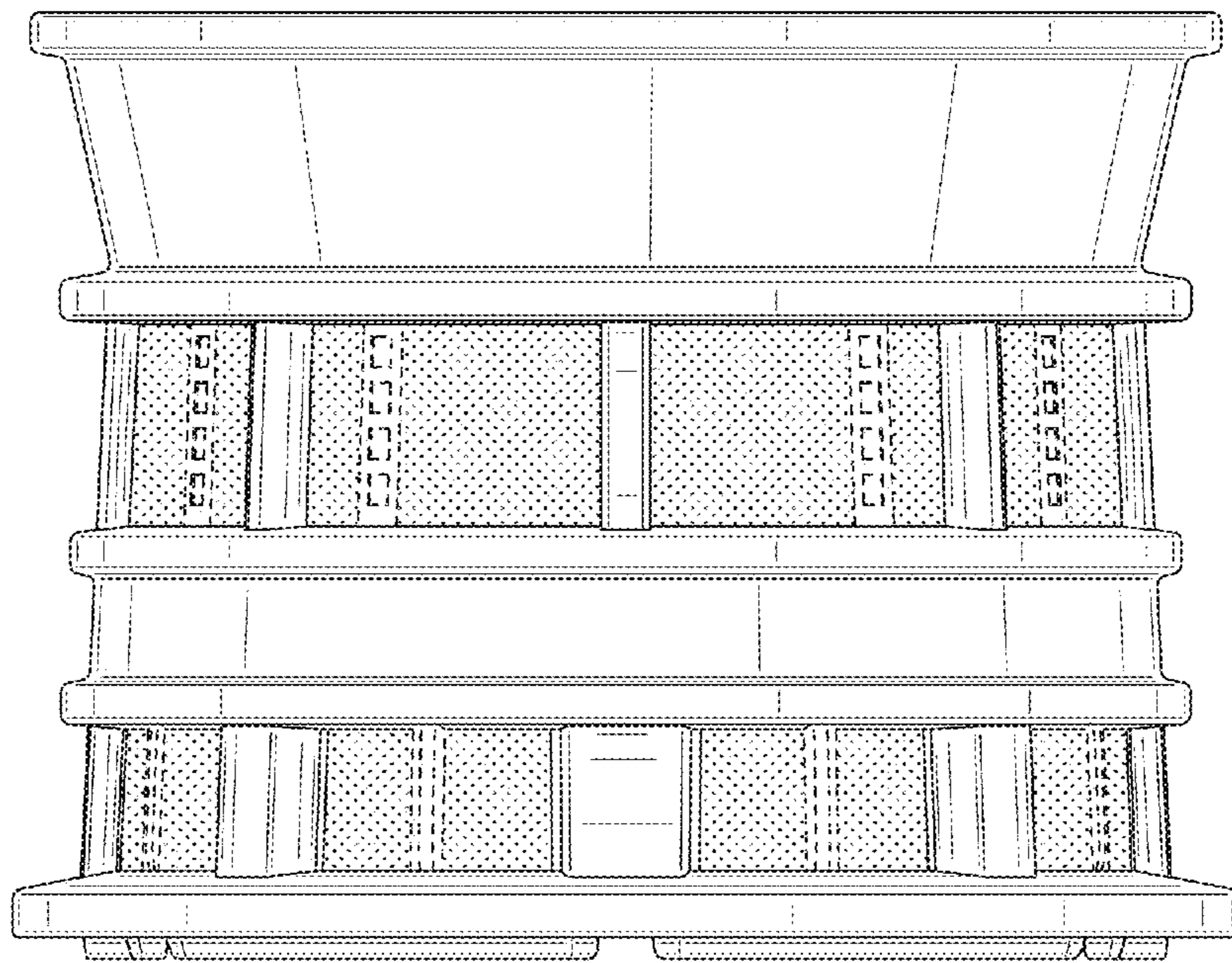

FIG. 20

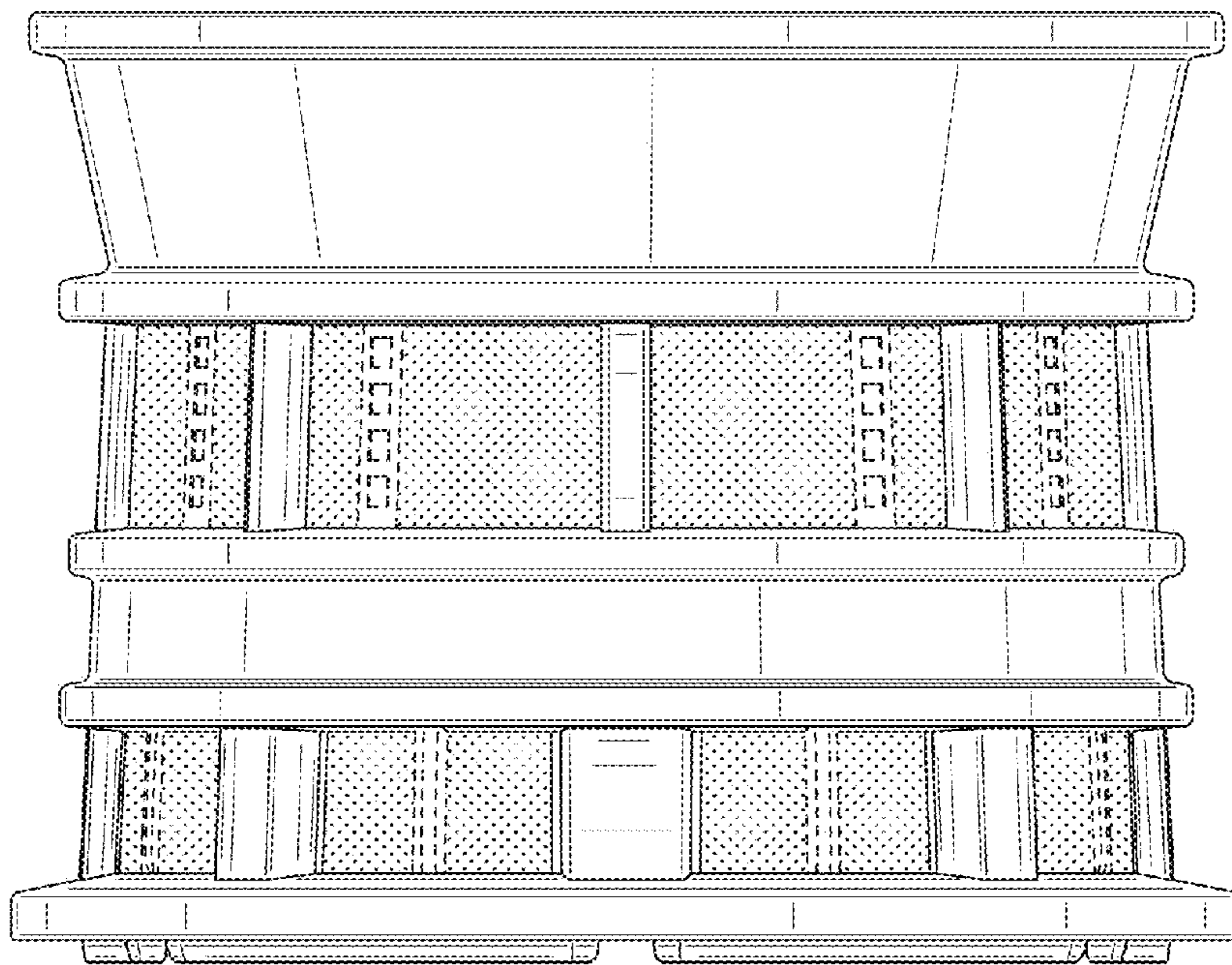

FIG. 21

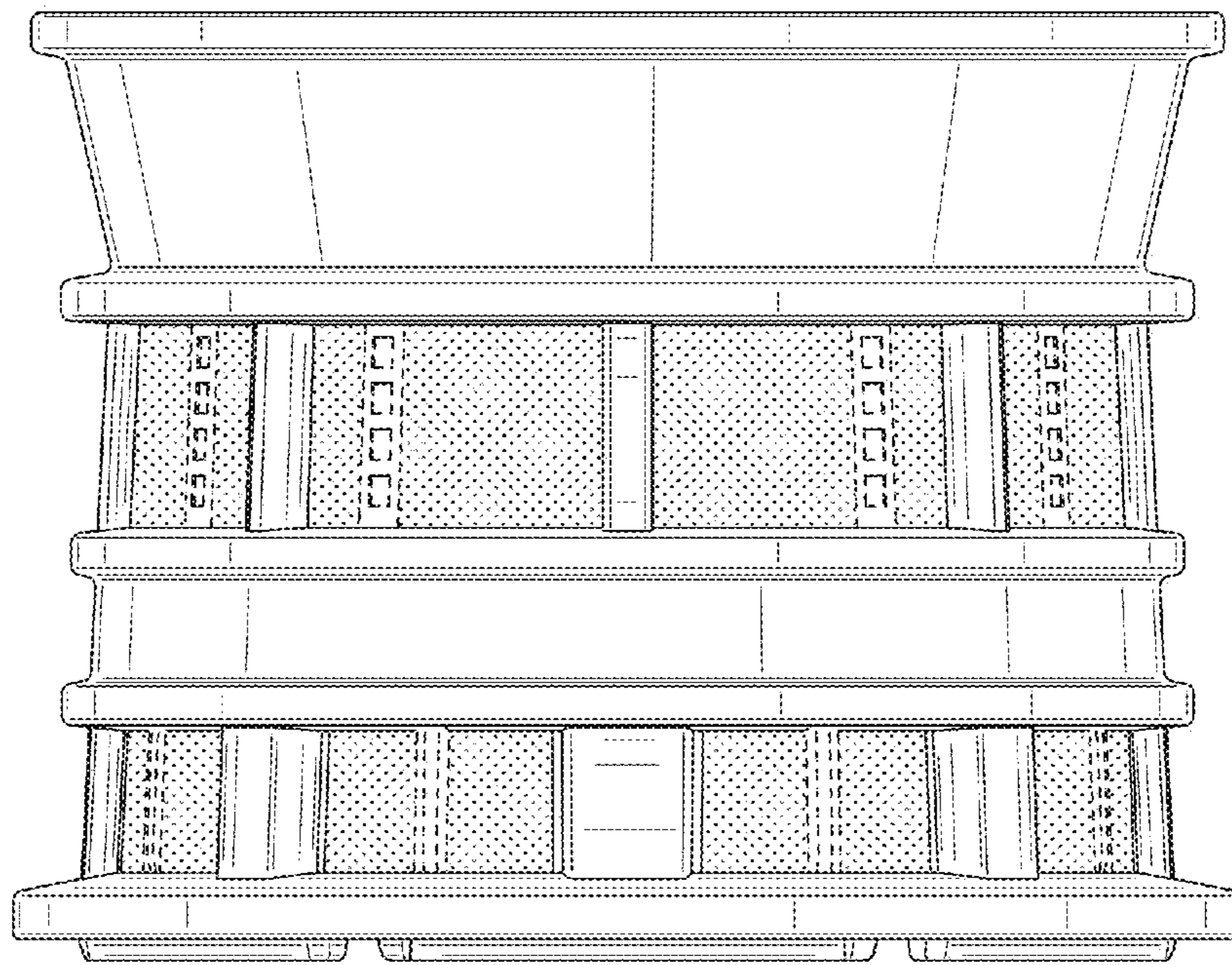

FIG. 22

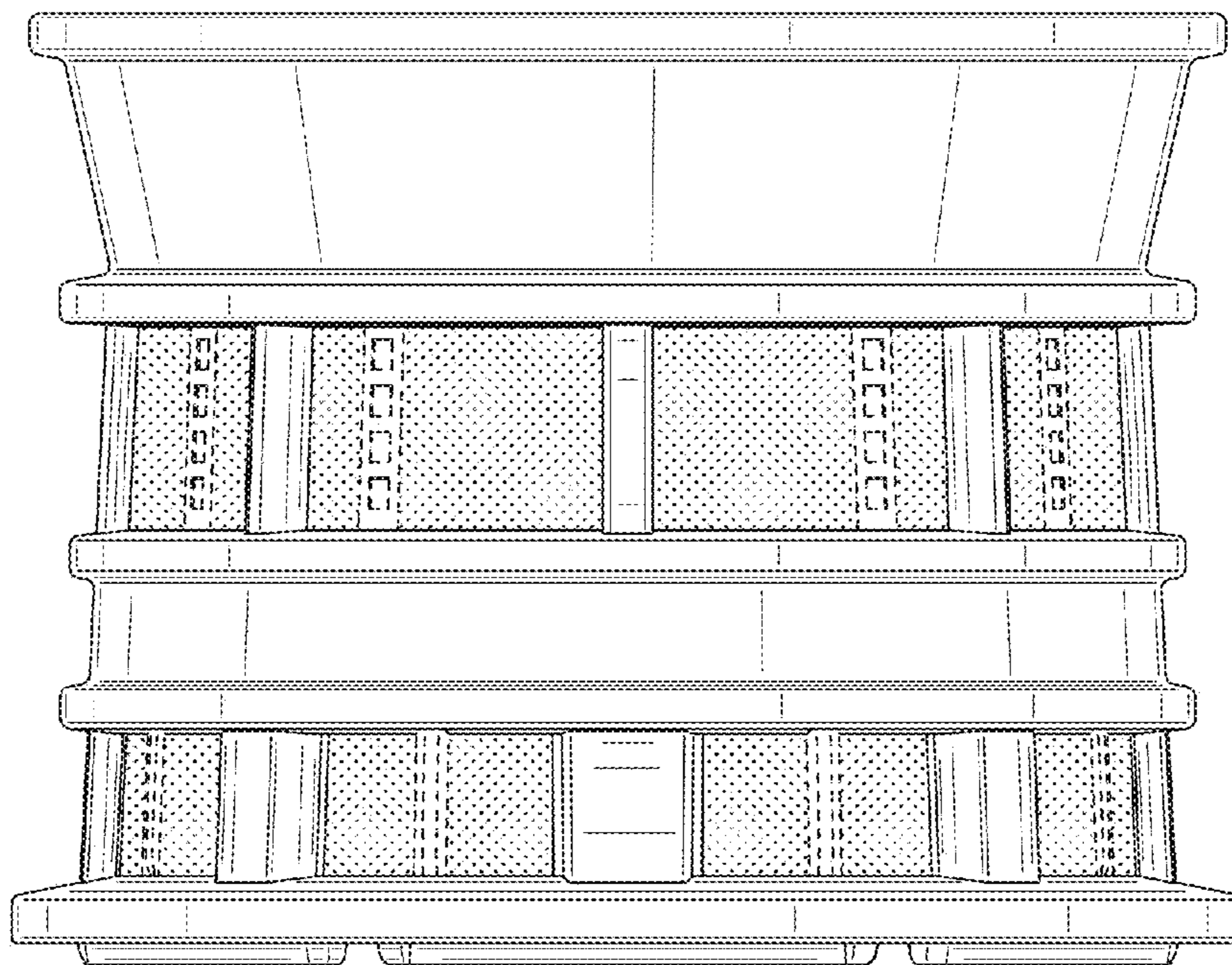

FIG. 23

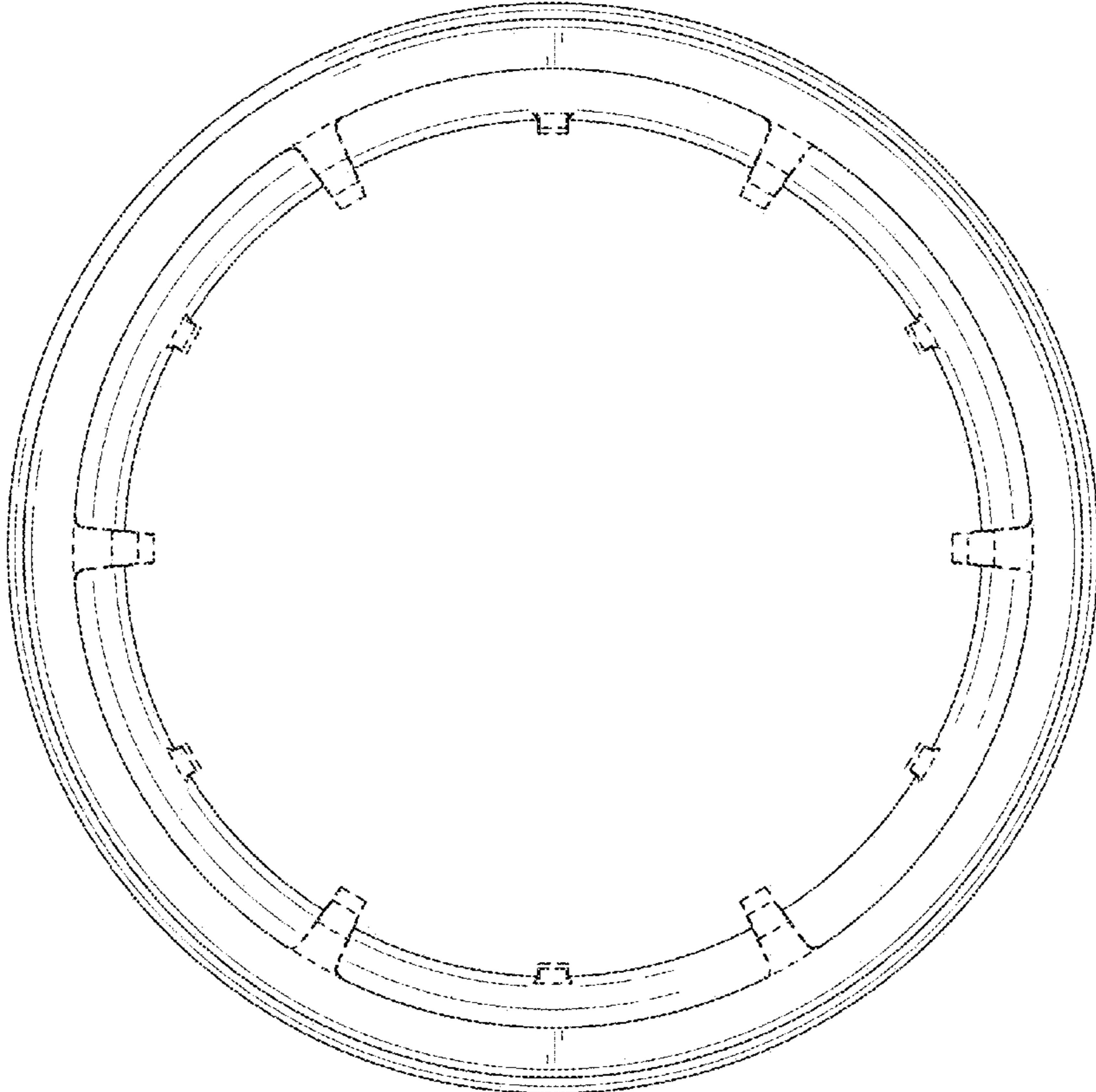

FIG. 24

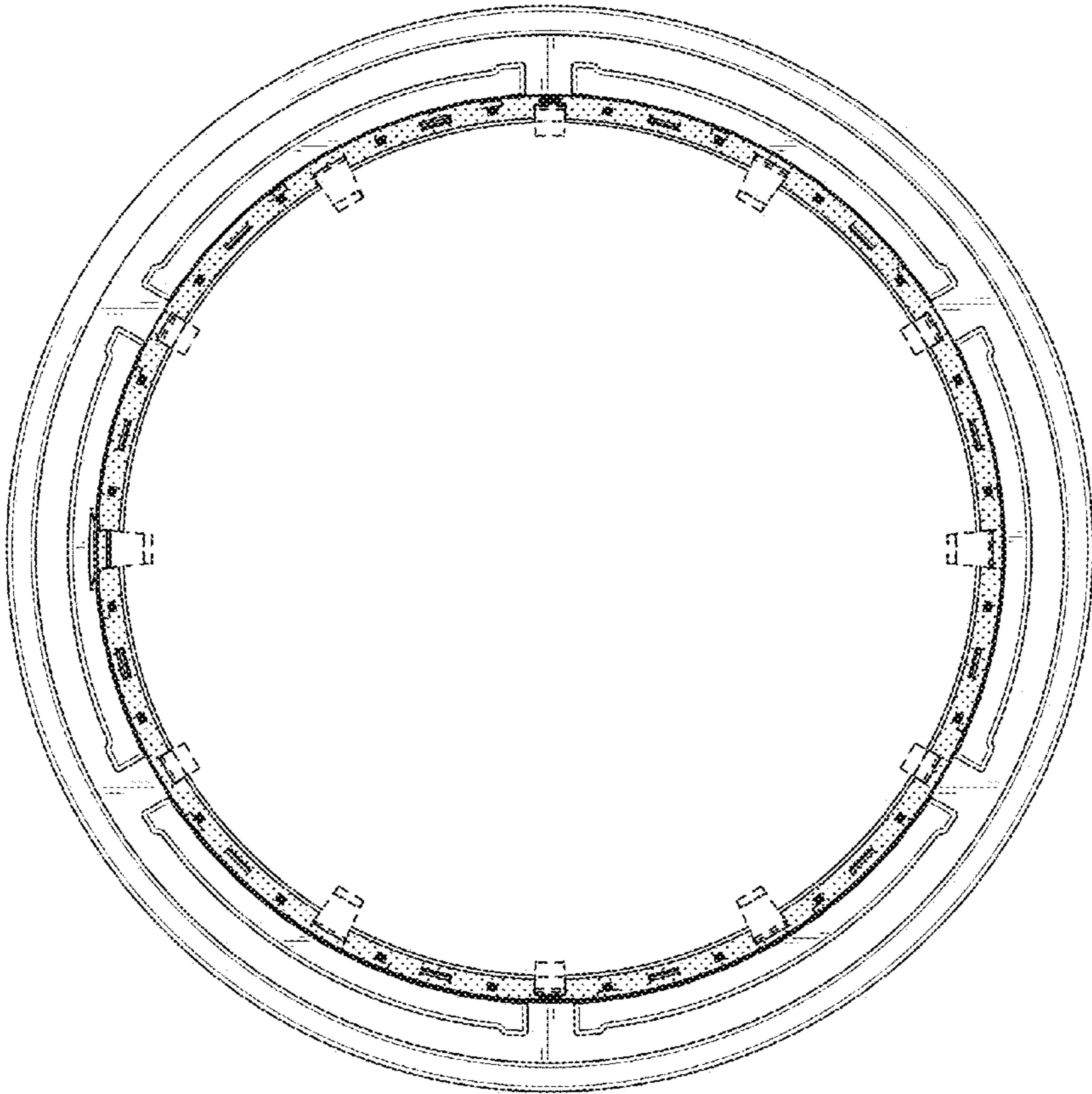

FIG. 25

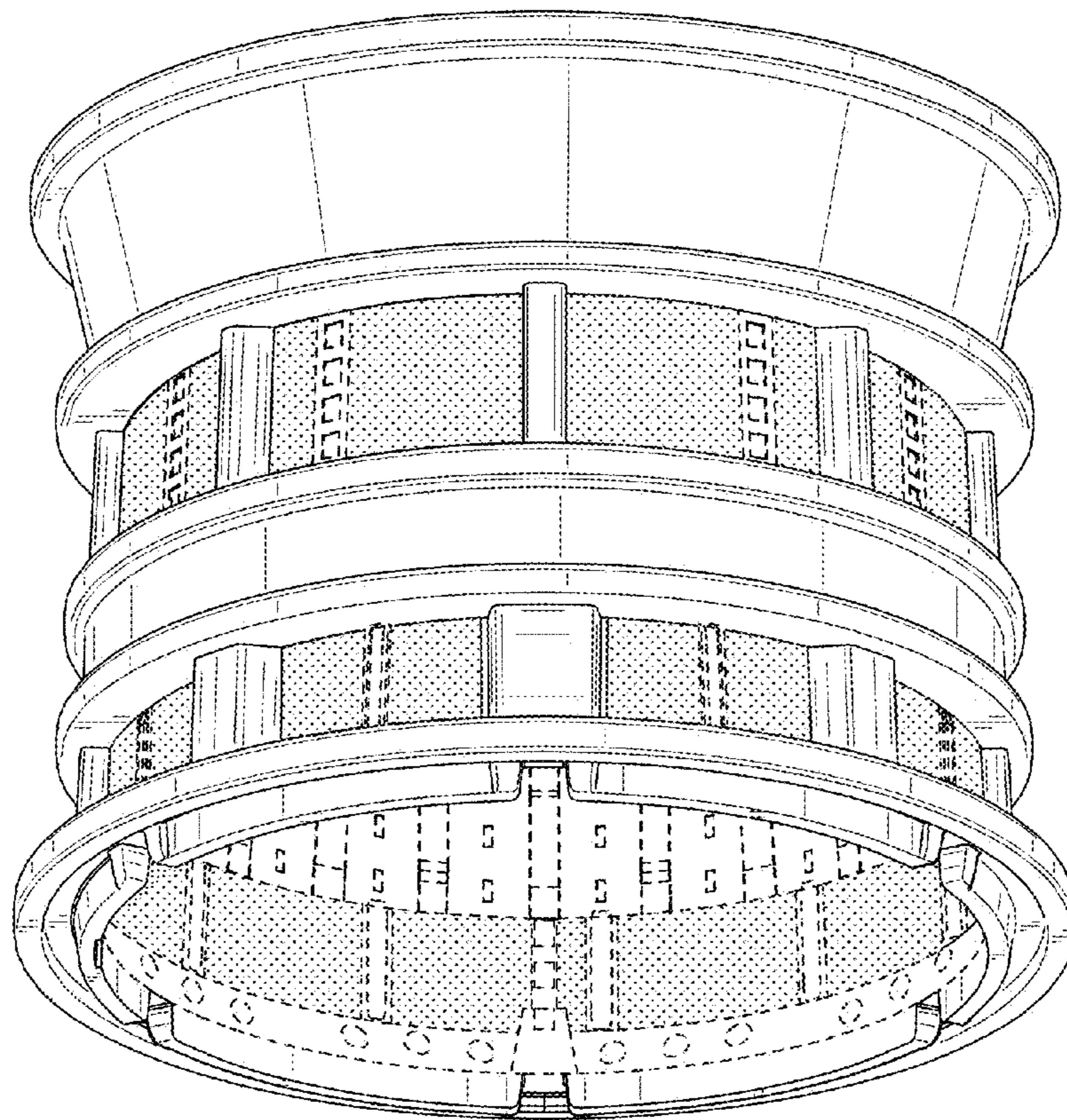

FIG. 26