



US00D713184S

(12) **United States Design Patent**
Rak

(10) **Patent No.:** **US D713,184 S**

(45) **Date of Patent:** **** Sep. 16, 2014**

(54) **TABLE**

(71) Applicant: **Jeremy Rak**, Lorain, OH (US)

(72) Inventor: **Jeremy Rak**, Lorain, OH (US)

(**) Term: **14 Years**

(21) Appl. No.: **29/445,811**

(22) Filed: **Feb. 16, 2013**

(51) **LOC (10) Cl.** **06-03**

(52) **U.S. Cl.**
USPC **D6/691.1**

(58) **Field of Classification Search**
USPC D6/690, 691.1, 691.2, 707, 707.15,
D6/707.19, 707.23; 108/153.1, 156, 157.1,
108/161

See application file for complete search history.

(56) **References Cited**

U.S. PATENT DOCUMENTS

D238,407 S *	1/1976	Owens	D6/485
D245,823 S *	9/1977	Fields	D6/511
D274,490 S *	7/1984	Hamami	D6/484
D485,094 S *	1/2004	Chang et al.	D6/485
D555,401 S *	11/2007	Adams et al.	D6/484

* cited by examiner

Primary Examiner — Janice Seeger

(74) *Attorney, Agent, or Firm* — John D. Gugliotta

(57) **CLAIM**

The ornamental design for a table, as shown and described.

DESCRIPTION

FIG. 1 is a front, top perspective view of a table showing my new design;

FIG. 2 is a rear, bottom perspective view thereof;

FIG. 3 is a top plan view thereof;

FIG. 4 is a bottom plan view thereof;

FIG. 5 is a side elevational view thereof, the opposite side being a mirror image; and,

FIG. 6 is a front elevational view thereof, the rear elevational view being a mirror image.

The drawings show a table design having a transparent or translucent, an opaque, textured horizontal surfaced under the top, and transparent or translucent leg structures. The wide dashed lines throughout the figures represent the perimeter of the table top and outline shape of the support leg structures and form no part of the claimed invention.

1 Claim, 6 Drawing Sheets

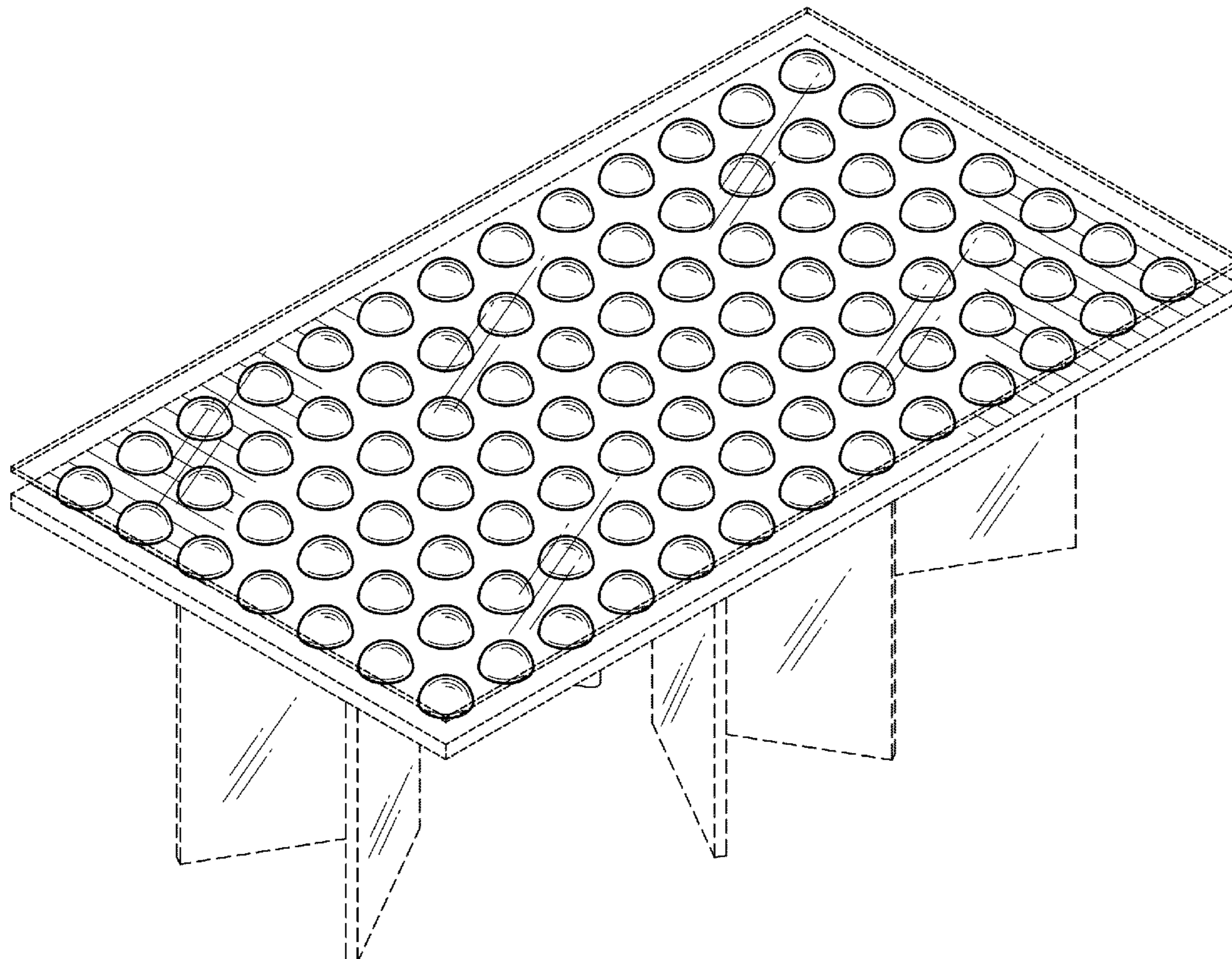

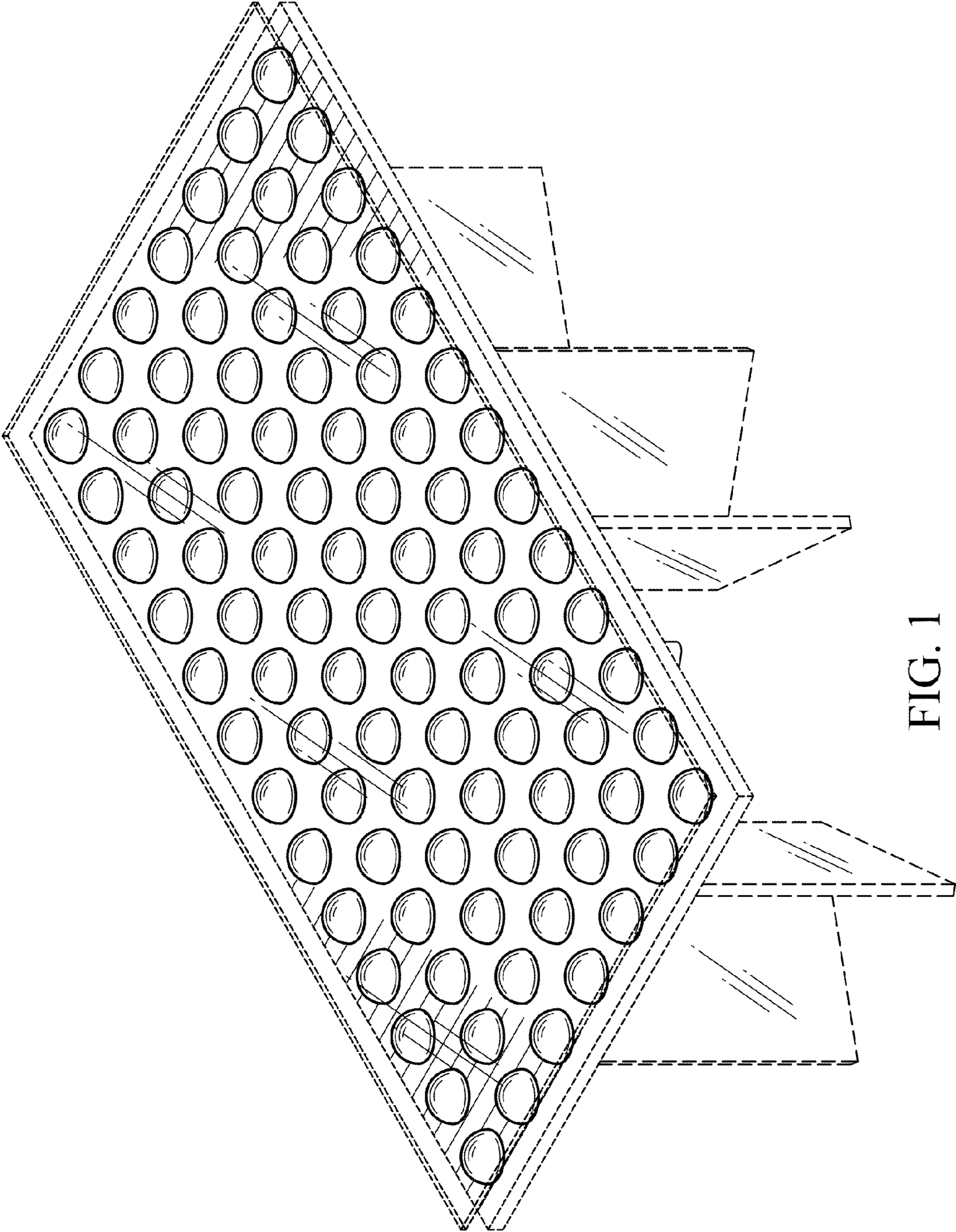

FIG. 1

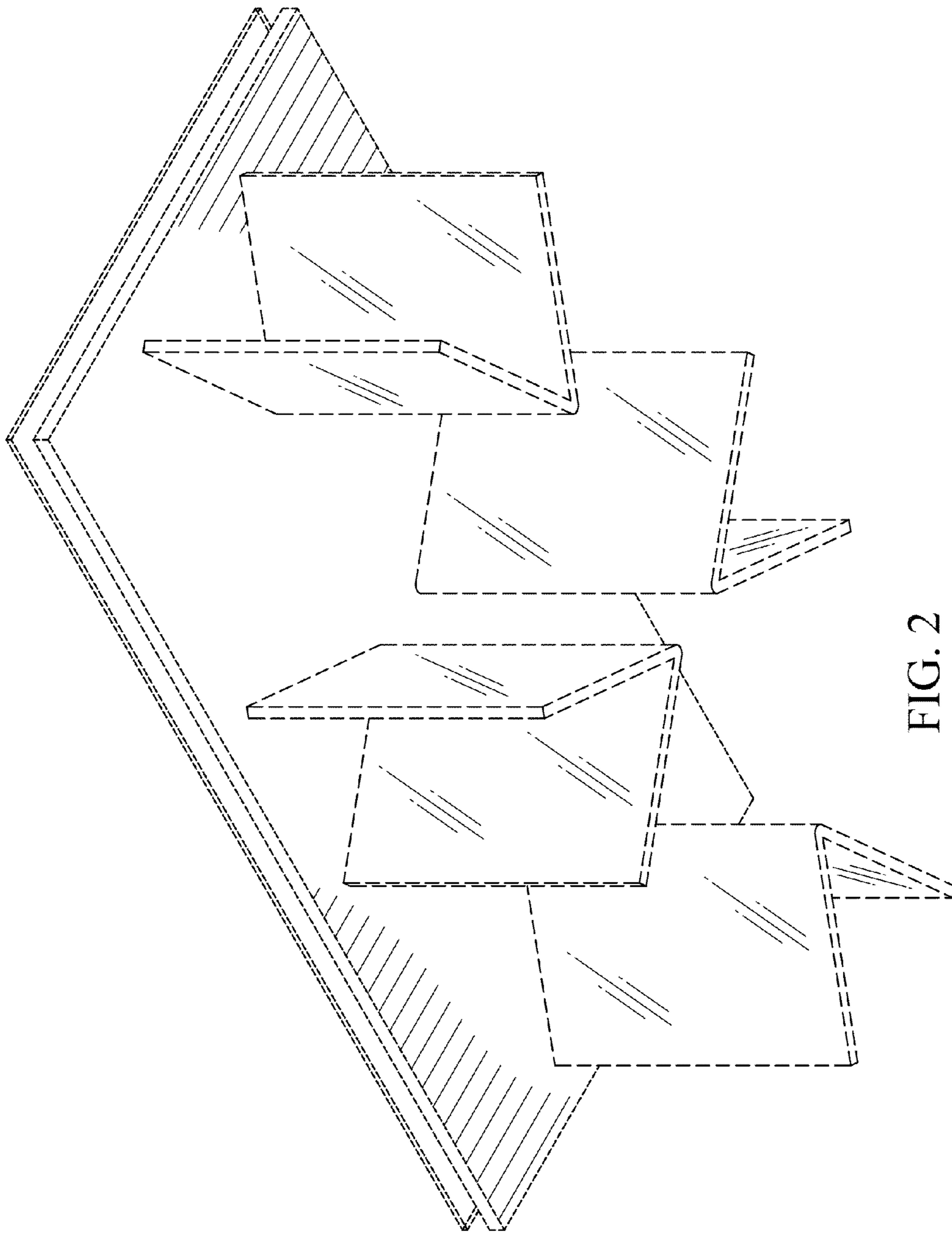

FIG. 2

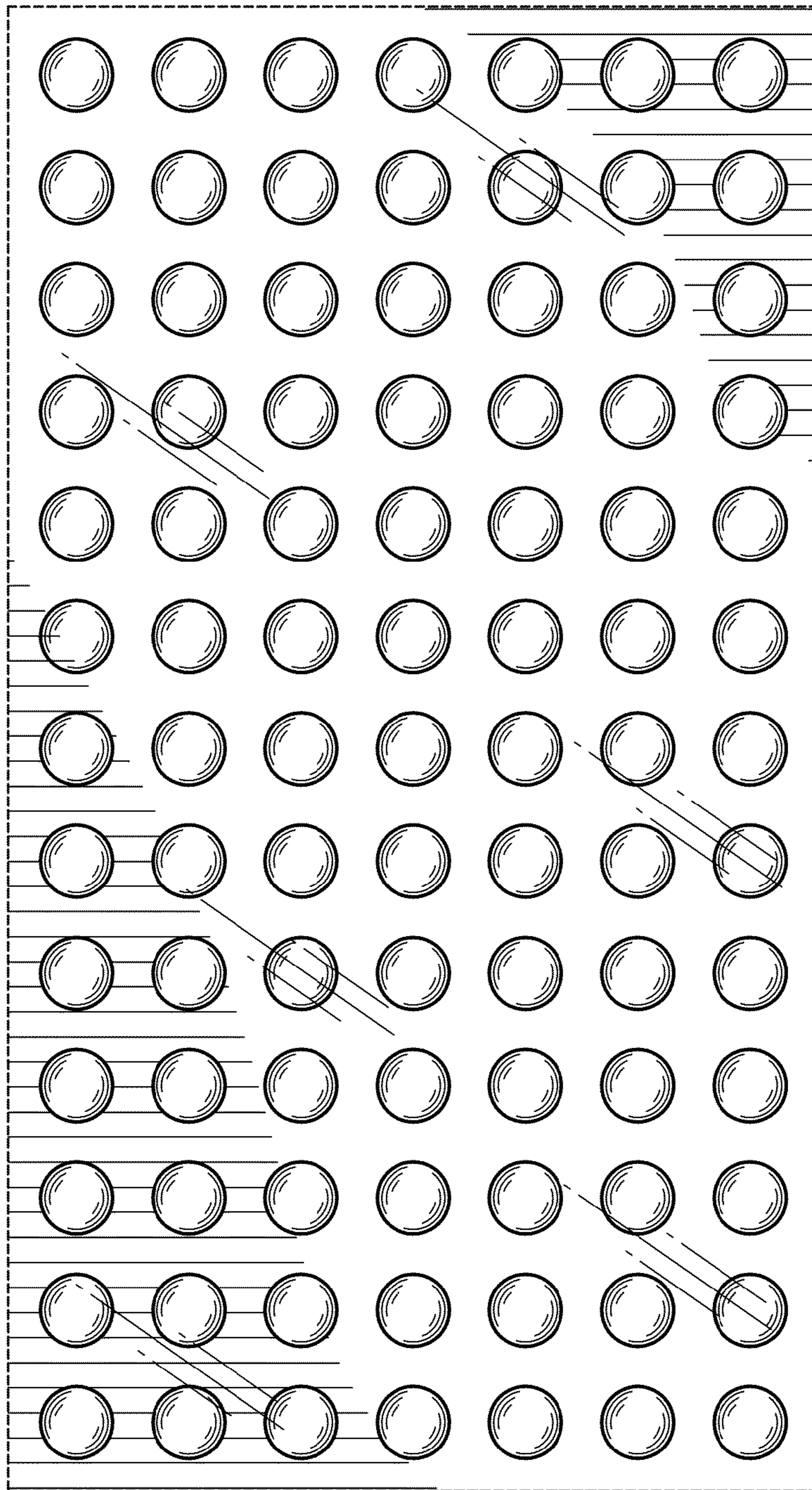

FIG. 3

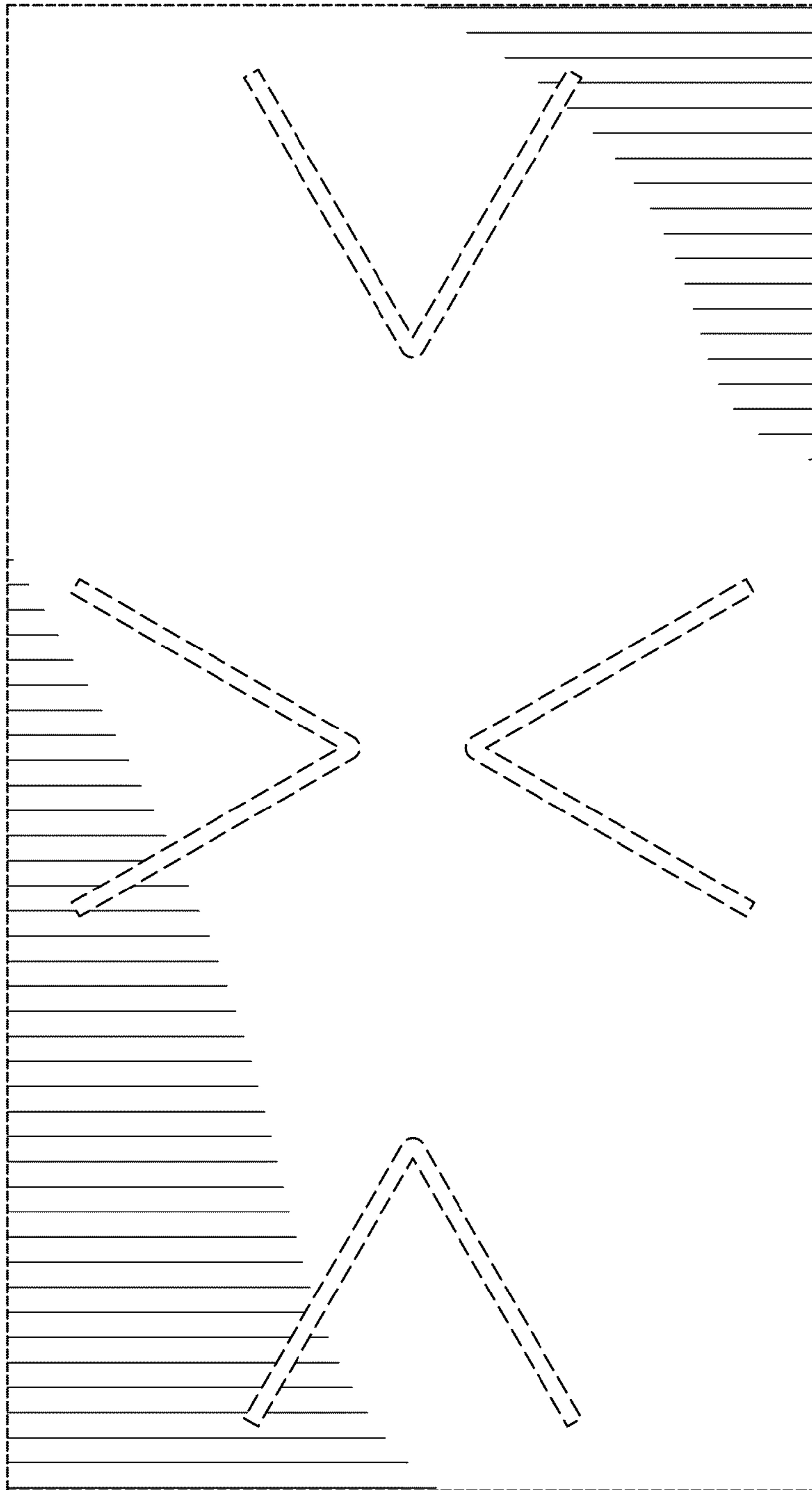

FIG. 4

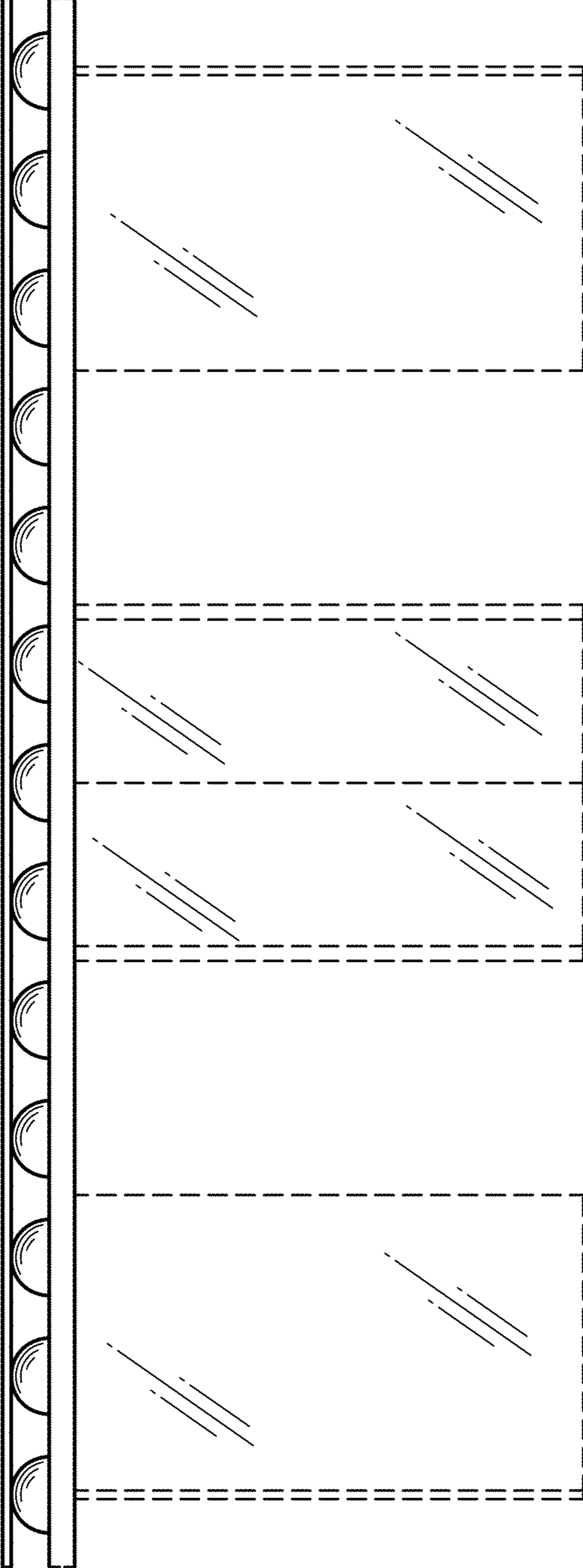

FIG. 5

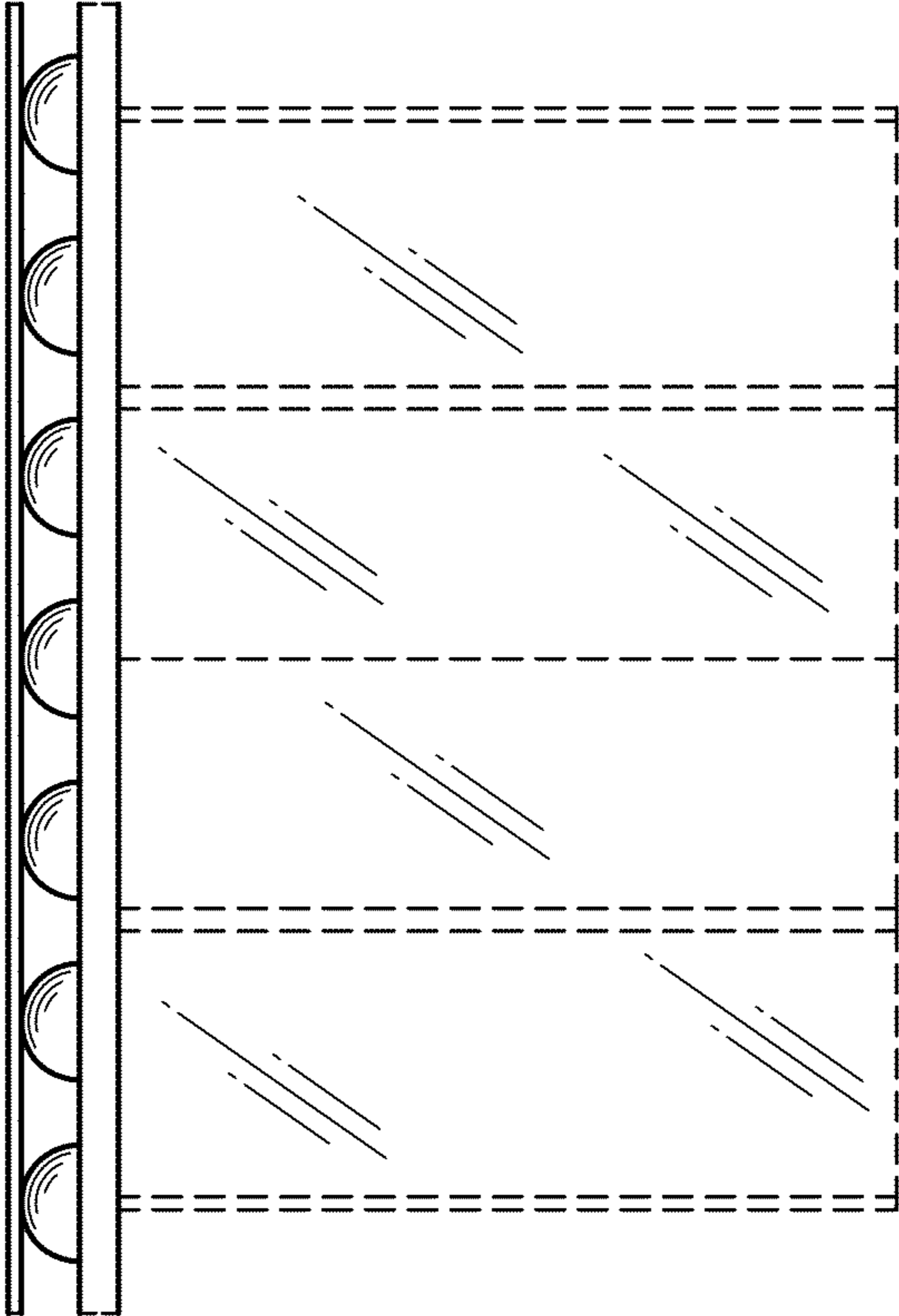

FIG. 6